



OPERATION MANUAL

DAIKIN ROOM AIR CONDITIONER



MODELS

- CTKS60TVMG
- CTKS71TVMG
- CTKB60TVMG



Features

Enhanced comfort and energy savings



INTELLIGENT EYE

The INTELLIGENT EYE sensor detects human movement in a room. If no one is in the room for more than 20 minutes, the operation automatically changes to energy saving operation.

▶ Page 15



WEEKLY TIMER

Up to 4 timer settings can be saved for each day of the week according to your family's life style. The WEEKLY TIMER allows you to set on/off times and the desired temperature. ▶ Page 21

Other functions



COMFORT AIRFLOW

The airflow direction is upward while in COOL and DRY operation. This function prevents cold air from blowing directly on your body. ▶ Page 15



OUTDOOR UNIT QUIET









OUTDOOR UNIT QUIET operation assures a low noise level of the outdoor unit. This function is useful to maintain a quiet neighbourhood. ▶ Page 18



ECONO



This function enables efficient operation by limiting the maximum power consumption. It is useful when using the air conditioner and other electrical devices simultaneously on a shared electrical circuit. ▶Page 18



Contents

Read Before Operation	
Safety Precautions.....	3
Names of Parts	5
Preparation Before Operation	10
Basic Operation	
 COOL · DRY · FAN ONLY Operation	12
 Adjusting the Airflow Rate.....	13
 Adjusting the Airflow Direction	14
Useful Functions	
 COMFORT AIRFLOW / INTELLIGENT EYE Operation.....	15
 POWERFUL Operation.....	17
 ECONO / OUTDOOR UNIT QUIET Operation	18
TIMER Operation	
 ON/OFF TIMER Operation	19
 WEEKLY TIMER Operation.....	21
Mobile Controller	
 Wireless LAN connection.....	27
Multi Connection	
Note for Multi System	28
Care	
Care and Cleaning.....	30
When the Need Arises	
FAQ.....	34
Troubleshooting	35

Safety Precautions

- Keep this manual where the user can easily find it.
- Read the precautions in this manual carefully before operating the unit.
- The precautions described herein are classified as **WARNING** and **CAUTION**. They both contain important information regarding safety. Be sure to observe all precautions without fail.

 WARNING	Failure to follow these instructions properly may result in personal injury or loss of life.
 CAUTION	Failure to observe these instructions properly may result in property damage or personal injury, which may be serious depending on the circumstances.

 Never attempt.	 Be sure to follow the instructions.	 Be sure to establish an earth connection.
--	---	---

- After reading, keep this manual in a convenient place so that you can refer to it whenever necessary. If the equipment is transferred to a new user, be sure also to hand over the manual.

WARNING

-  To avoid fire, explosion or injury, do not operate the unit when harmful gases (e.g. flammable or corrosive) are detected near the unit.
- Be aware that prolonged, direct exposure to cool air from the air conditioner, or to air that is too cool can be harmful to your physical condition and health.
- Do not place objects, including rods, your fingers, etc., in the air inlet or outlet. Product damage or personal injury may result due to contact with the air conditioner's high-speed fan blades.
- Do not attempt to repair, dismantle, reinstall or modify the air conditioner yourself as this may result in water leakage, electric shock or fire hazards.
- Do not use flammable spray near the air conditioner, or otherwise fire may result.
- Do not use a refrigerant other than the one indicated on the outdoor unit (R410A) when installing, moving or repairing. Using other refrigerants may cause trouble or damage to the unit, and personal injury.
- To avoid electric shock, do not operate with wet hands.

-  Beware of fire in case of refrigerant leakage. If the air conditioner is not operating correctly, i.e. not generating cool air, refrigerant leakage could be the cause. Consult your dealer for assistance. The refrigerant within the air conditioner is safe and normally does not leak. However, in the event of a leakage, contact with a naked burner, heater or cooker may result in generation of noxious gas. Do not use the air conditioner until a qualified service person confirms that the leakage has been repaired.
- Do not attempt to install or repair the air conditioner yourself. Improper workmanship may result in water leakage, electric shock or fire hazards. Please contact your local dealer or qualified personnel for installation and maintenance work.
- If the air conditioner is malfunctioning (giving off a burning odour, etc.), turn off power to the unit and contact your local dealer. Continued operation under such circumstances may result in a failure, electric shock or fire hazards.
- Be sure to install an earth leakage circuit breaker. Failure to install an earth leakage circuit breaker may result in electric shock or fire.

-  Be sure to earth the unit. Do not earth the unit to a utility pipe, lightning conductor or telephone earth lead. Imperfect earthing may result in electric shock.

CAUTION

-  Do not use the air conditioner for purposes other than those for which it is intended. Do not use the air conditioner for cooling precision instruments, food, plants, animals or works of art as this may adversely affect the performance, quality and/or longevity of the object concerned.
- Do not expose plants or animals directly to the airflow from the unit as this may cause adverse effects.
- Do not place appliances that produce naked flames in places exposed to the airflow from the unit as this may impair combustion of the burner.
- Do not block the air inlets nor outlets. Impaired airflow may result in insufficient performance or trouble.
- Do not sit on the outdoor unit, put things on the unit, or pull the unit. Doing so may cause accidents, such as falling or toppling down, thus resulting in injury, product malfunctioning, or product damage.

-  Do not place objects that are susceptible to moisture directly beneath the indoor or outdoor units. Under certain conditions, condensation on the main unit or refrigerant pipes, air filter dirt or drain blockage may cause dripping, resulting in fouling or failure of the object concerned.
- After prolonged use, check the unit stand and its mounts for damage. If they are left in a damaged condition, the unit may fall and cause injury.
- To avoid injury, do not touch the air inlet or aluminium fins of the indoor or outdoor units.
- The appliance is not intended for use by unattended young children or infirm persons. Impairment of bodily functions and harm to health may result.
- Children should be supervised to ensure that they do not play with the unit or its remote controller. Accidental operation by a child may result in impairment of bodily functions and harm health.
- Avoid impacts to the indoor and outdoor units, or otherwise product damage may result.
- Do not place flammable items, such as spray cans, within 1m of the air outlet.
The spray cans may explode as a result of hot air from the indoor or outdoor units.
- Be careful not to let pets urinate on the air conditioner. Urination on the air conditioner may result in electric shocks or fire.
- Do not wash the air conditioner with water, as this may result in electric shocks or fire.
- Do not place water containers (vases, etc.) above the unit, as this may result in electric shocks or fire hazards if they should topple over.
- Do not insert the batteries in the wrong polarity (+/-) orientation as this may result in short circuiting, fire, or battery leakage.

-  To avoid oxygen depletion, ensure that the room is adequately ventilated if equipment such as a burner is used together with the air conditioner.
- Before cleaning, be sure to stop unit operation and turn off the circuit breaker. Otherwise, an electric shock and injury may result.
- Only connect the air conditioner to the specified power supply circuit. Power supplies other than the one specified may result in electric shocks, overheating and fires.
- Arrange the drain hose to ensure smooth drainage. Imperfect drainage may cause wetting of the building, furniture, etc.
- Do not place objects in direct proximity of the outdoor unit and do not let leaves and other debris accumulate around the unit. Leaves are a hotbed for small animals which can enter the unit. Once inside the unit, such animals can cause malfunctions, smoke or fire if they come into contact with electrical parts.
- Do not place objects around the indoor unit.
Doing so may have an adverse influence on the performance, product quality, and life of the air conditioner.
- This appliance is not intended to be used by persons with reduced physical, sensory or mental capabilities, or with lack of operation knowledge, unless they have been given supervision or instruction concerning the appliance use by person responsible for their safety. Keep out of children's reach to ensure that they do not play with the appliance.
- For care and cleaning, call service personnel.
- Do not sit or hang on the panel. The panel may fall, and injury or product malfunctioning may result.
- Do not sway the panel. The panel may hit people or objects, and injury or property damage may result.
- Do not let children play around the panel. Injury or property damage may result.
- Do not pull the wires. The wires may be broken and the panel may fall, and injury or property damage may result.
- Do not locate obstacles in the route. The panel may fall, and injury or property damage may result.
- Do not bend or damage the wires. The wires may be broken and the panel may fall, and injury or property damage may result.
- Do not put objects on the panel, or otherwise production malfunctioning may result.
- Do not use an unstable stand at the time of operating or maintaining the air conditioner, or otherwise you may topple over or injury yourself.
- Locate the remote controller in places out of reach of children. The wrong operation of the remote controller may result in injury.

This is an appliance that is not accessible to the general public.

Precautions relating to area surrounding the indoor and outdoor units

- Be sure to follow the instructions below.
 - The indoor unit is at least 1m away from any television or radio set (unit may cause interference with the picture or sound).
 - Refrain from using the units in areas prone to high levels of oily smoke, such as a kitchen. Water leakage may result.

Names of Parts

Indoor Unit

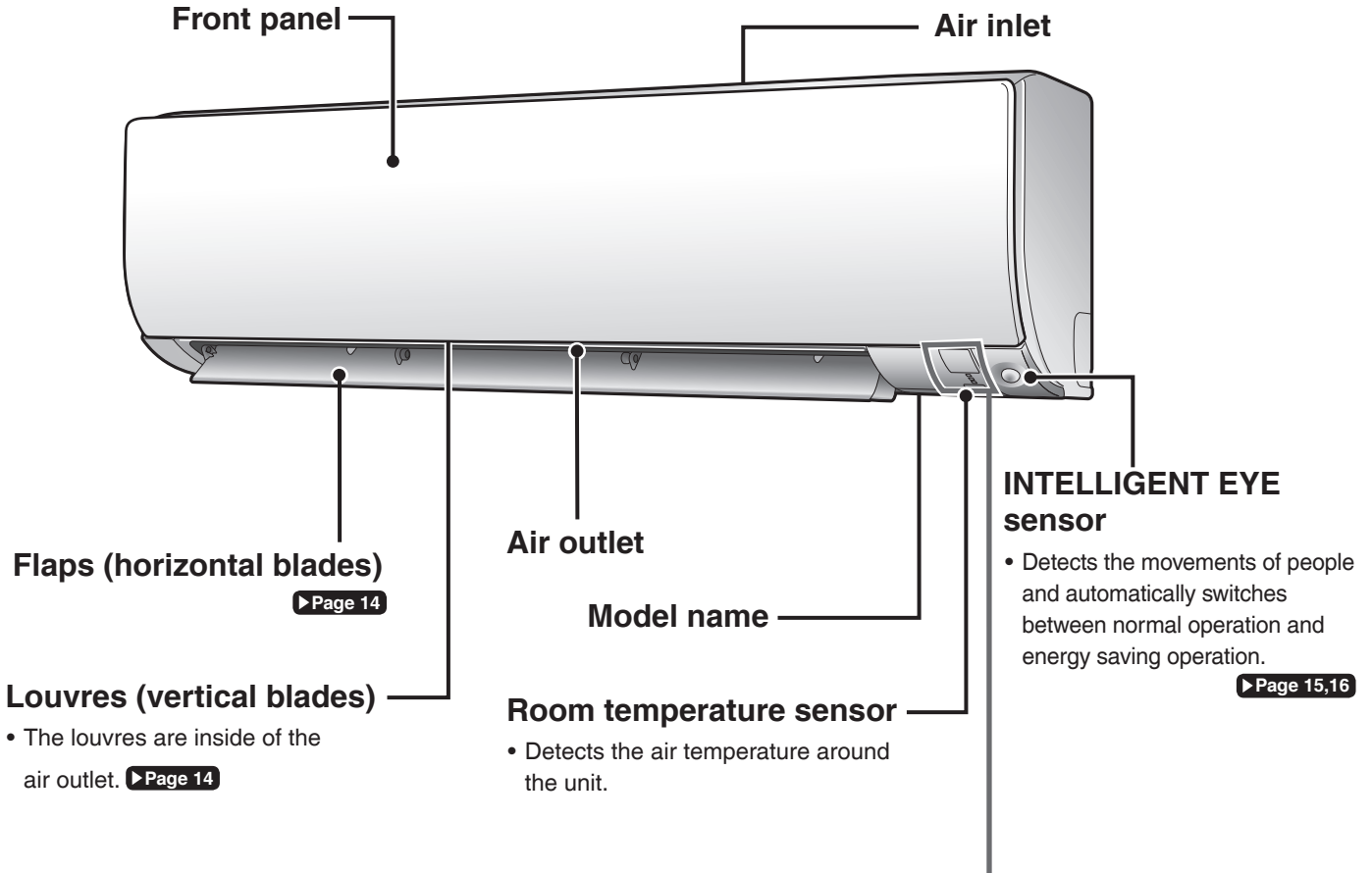

Display

Signal receiver

- Receives signals from the remote controller.
- When the unit receives a signal, you will hear a beep sound.

Case	Sound type
Operation start	beep-beep
Setting changed	beep
Operation stop	long beep

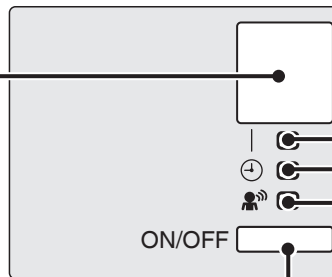

Indoor unit ON/OFF switch

- Press this switch once to start operation. Press once again to stop it.
- For the operation mode setting, refer to the following table.

Mode	Temperature setting	Airflow rate
COOL	22°C	AUTO

- This switch can be used when the remote controller is missing.

■ Open the front panel

Wireless LAN connecting adapter

Model name	Wireless LAN connecting adapter	Part No.
CTKS	Included with the air conditioner	BRP072C42
CTKB*	Sold separately	BRP072C42

▶ Page 27

* For CTKB model, refer to the installation manual of option Wireless LAN connecting adapter for installation.

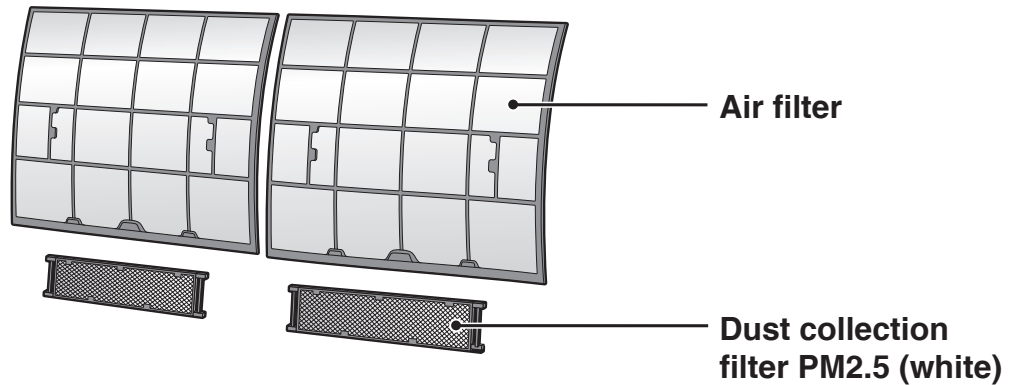
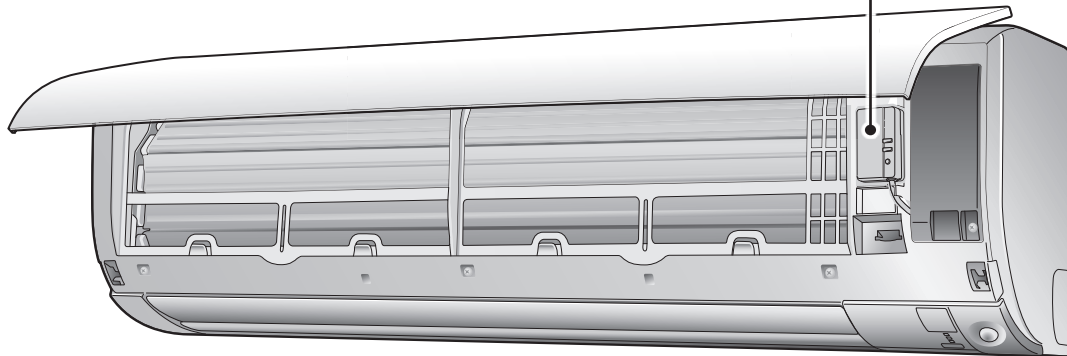

Outdoor Unit

- The appearance of the outdoor unit may differ between different models.

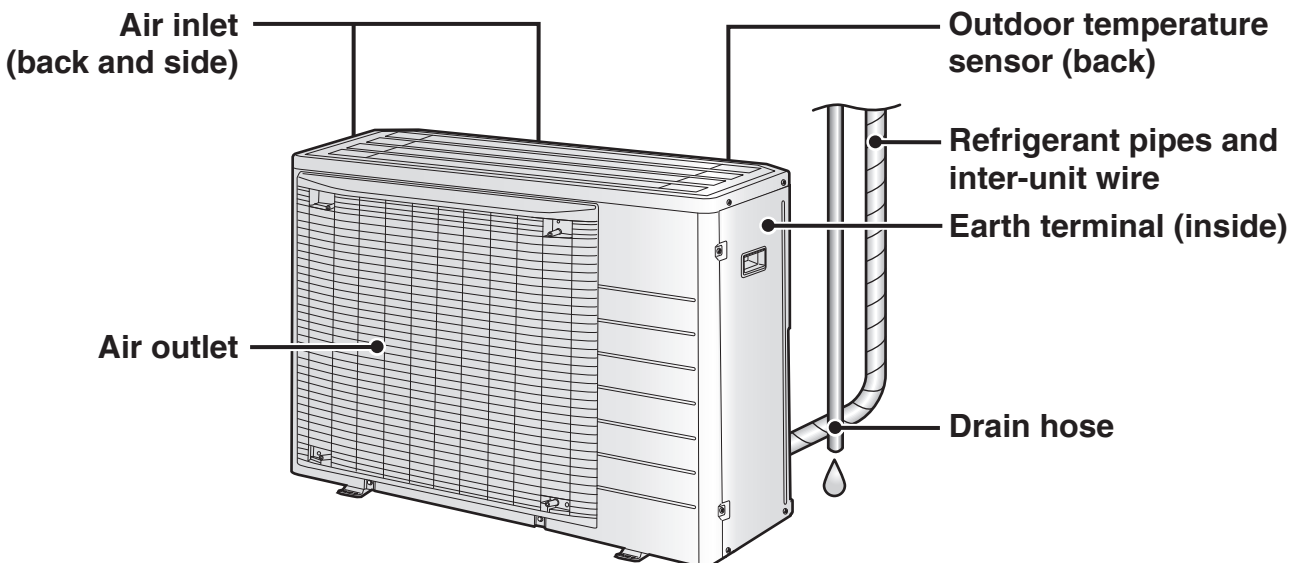

Names of Parts

Wireless LAN connecting adapter

(The product is inside the indoor unit and may be different depending on the air conditioner model type)

CAUTION

- In case the Wireless LAN connecting adapter is optional (CTKB model), it must be installed by your dealer or a technician. (Installing it by yourself could cause electric shock or fire.)

ATTENTION

- When the Wireless LAN connecting adapter is operated, the RUN lamp may light through the front panel. If you find the lamp disturbing, the lamp can be disabled via the mobile application^[1].

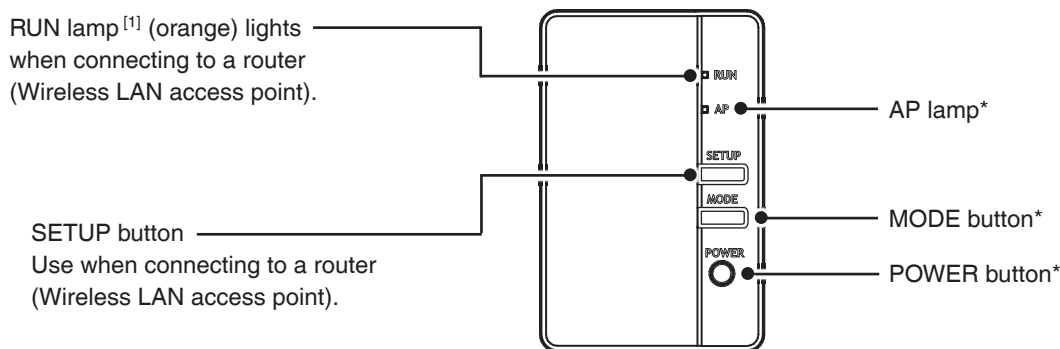

* No operation for BRP072C42 model.

[1] The RUN lamp LED can be disabled via the mobile application

- Make sure the controller is connected to the Wireless LAN adapter and RUN lamp is lit.

To turn off the RUN lamp via the mobile application.

- 1) Open "DAIKIN Mobile Controller" in your smartphone or tablet.
- 2) Select "Setting" or icon "⚙️".
- 3) Select "Adapter LEDs" and turn it off.
 - The RUN lamp turns off.
 - Mobile controller continues operating.

Specifications

Frequency range	2400 MHz–2483.5 MHz
Radio protocol	IEEE 802.11b/g/n
RF channel	1–13
Power supply	DC 14 V / 100 mA

RF channel: Radio frequency channel

Configuration

- The user is responsible for providing the following items before using this product:
 - Smartphone or tablet PC (Supported OS: Android 2.3.3 or later; iOS 5.0 or later.)
 - Internet line and communicating device (Modem/router or similar device)
 - Wireless LAN access point
 - Application name: [DAIKIN Mobile Controller] (free)

For details on the installation method for the DAIKIN Mobile Controller application, please see [▶ Page 27](#)

NOTE

Notes on the Wireless LAN connecting adapter

- Do not use this product near a microwave oven. (This can affect Wireless LAN communications.)
- For the latest details about installation of the Wireless LAN connecting adapter and applicable units, refer to the web site <http://www.daikintha.com/product/dmobile>.

Remote Controller

Signal transmitter

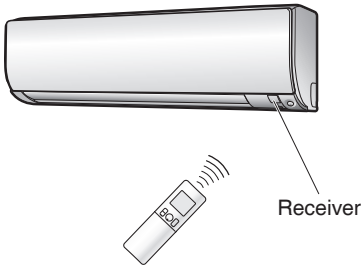

- To use the remote controller, aim the transmitter at the indoor unit. If there is anything blocking the signals between the unit and the remote controller, such as a curtain, the unit may not operate.
- The maximum transmission distance is about 7m.

FAN setting button

- Selects the airflow rate setting. ▶ Page 13

POWERFUL button

- POWERFUL operation. ▶ Page 17

Display (LCD)

- Displays the current settings. (In this illustration, each section is shown with all its displays on for the purpose of explanation.)

TEMPERATURE adjustment button

- Changes the temperature setting. ▶ Page 12

ON/OFF button

- Press this button once to start operation. Press once again to stop it. ▶ Page 12

Front cover

- Open the front cover. ▶ Page 9

Model name ARC466A19

Names of Parts

■ Open the front cover

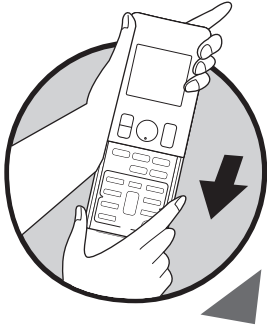

MODE selector button

- Selects the operation mode. (DRY/COOL/FAN)

▶ Page 12

ECONO/QUIET button

- ECONO/OUTDOOR UNIT QUIET operation. ▶ Page 18

SWING button

- Adjusts the airflow direction. ▶ Page 14

COMFORT/SENSOR button

- COMFORT AIRFLOW and INTELLIGENT EYE operation. ▶ Page 15

OFF TIMER button (NIGHT SET mode)

▶ Page 20

TIMER CANCEL button

- Cancels the timer setting. ▶ Page 19,20
- Cannot be used for the WEEKLY TIMER operation.

SELECT button

- Changes the clock, ON/OFF TIMER and WEEKLY TIMER settings.

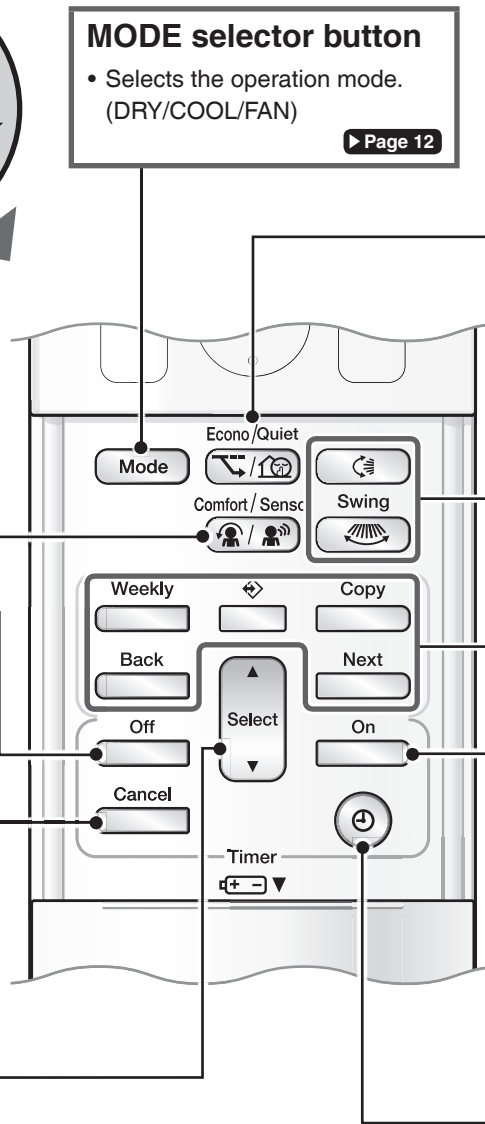

Weekly

Weekly button

PROGRAMME button

Copy

COPY button

Back

BACK button

Next

NEXT button

- WEEKLY TIMER operation. ▶ Page 21

ON TIMER button

▶ Page 19

CLOCK button

▶ Page 11

Preparation Before Operation

CAUTION

Incorrect handling of batteries can result in injury from battery leakage, rupturing or heating, or lead to equipment failure.

Please observe the following precautions and use safely.

- If the alkaline solution from the batteries should get in the eyes, do not rub the eyes. Instead, immediately flush the eyes with tap water and seek the attention of a medical professional.
- Keep batteries out of reach of children. In the event that batteries are swallowed, seek the immediate attention of a medical professional.
- Do not expose batteries to heat or fire. Do not disassemble or modify batteries. The insulation or gas release vent inside the battery may be damaged, resulting in battery leakage, rupturing, or heating.
- Do not damage or peel off labels on the batteries.

■ To insert the batteries

1. Slide the front cover to take it off.
2. Insert 2 dry batteries AAA.LR03 (alkaline).
3. Replace the front cover.

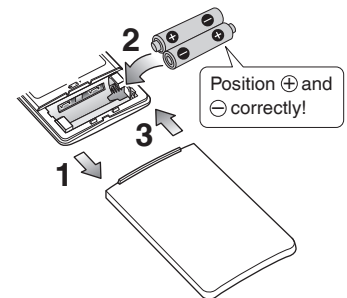

■ To fix the remote controller holder to a wall

1. Choose a place from where the signals reach the unit.
2. Fix the holder to a wall, a pillar, or similar location with the screws supplied with the holder.
3. Place the remote controller in the remote controller holder.

■ Turn on the circuit breaker

- After the power is turned on, the flaps of the indoor unit open and close once to set the reference position.

■ To check the function of the Wireless LAN connecting adapter

1. Open the front panel. ▶ Page 31
2. Turn on the main power supply and check that the RUN lamp of the Wireless LAN connecting adapter lights.
3. Close the front panel. ▶ Page 31

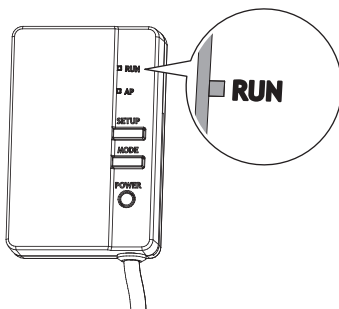

- When turning on the power, always attach the Wireless LAN connecting adapter case (upper).

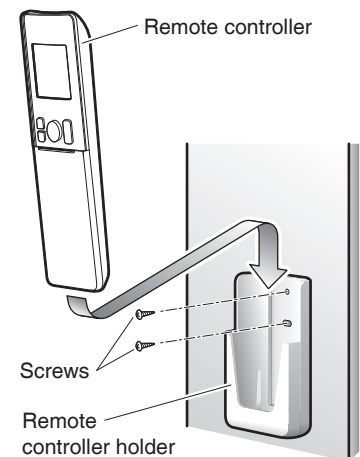

NOTE

Notes on batteries

- To avoid possible injury or damage from battery leakage or rupturing, remove the batteries when not using the product for long periods of time.
- The standard replacement time is 1 year. Both batteries should be replaced at the same time. Be sure to replace them with new size AAA.LR03 (alkaline) batteries.
- When battery power has run out, the LCD will begin blinking as an alert that the batteries need replacing. In some cases, when battery consumption is accelerated owing usage conditions, signal reception may decline before the LCD begins blinking.
- The batteries supplied with the remote controller are for initial operation. The batteries may run out in less than 1 year.

Note on remote controller

- Do not drop the remote controller. Do not get it wet.

Preparation Before Operation

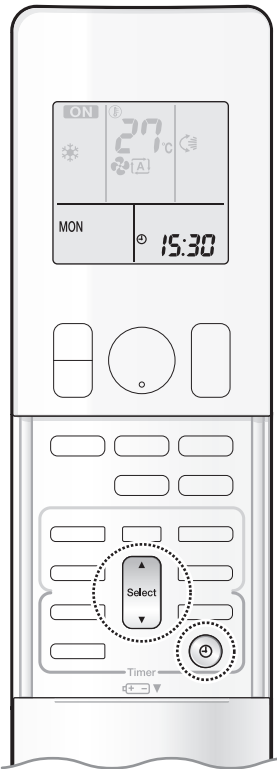

■ To set the clock

1. Press .

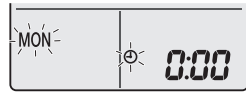

“0:00” appears on the LCD.
“MON” and “” blink.

2. Press  **to set the current day of the week.**

3. Press .



“” blinks.

4. Press  **to set the clock to the present time.**

- Holding down  or  rapidly increases or decreases the displayed time.

5. Press .

- Point the remote controller at the indoor unit when pressing the buttons.



“.” blinks.

NOTE

Note on setting the clock

- If the indoor unit's internal clock is not set to the correct time, the ON/OFF TIMER and WEEKLY TIMER will not operate punctually.



COOL · DRY · FAN ONLY Operation

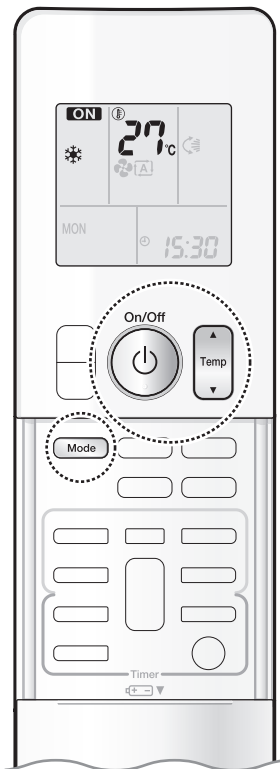

The air conditioner operates with the operation mode of your choice. From the next time on, the air conditioner will operate with the same operation mode.

■ To start

1. Press and select an operation mode.

- Each pressing of the button changes the mode setting in sequence.

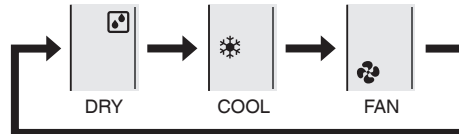

2. Press .

- “**ON**” appears on the LCD.
- The OPERATION lamp lights green.

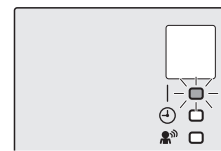

Display

■ To stop

▶ Press again.

- “**ON**” disappears from the LCD.
- The OPERATION lamp goes off.

■ To change the temperature setting

▶ Press .

- Press ▲ to raise the temperature and press ▼ to lower the temperature. Each pressing of the button changes the temperature by 1°C.

COOL operation	DRY or FAN operation
18-32°C	The temperature setting cannot be changed.

NOTE

Note on DRY operation

- Eliminates humidity while maintaining the indoor temperature as much as possible. It automatically controls temperature and airflow rate, so manual adjustment of these functions is unavailable.

Tips for saving energy

Keeping the temperature setting at a moderate level helps save energy.

- Recommended temperature setting for cooling: 26-28°C

Cover windows with a blind or a curtain.

- Blocking sunlight and air from outdoors increases the cooling effect.

Keep the air filters clean.

- Clogged air filters cause inefficient operation and waste energy. Clean them once in about every 2 weeks. ▶ [Page 30](#)

If you are not going to use the air conditioner for a long period, for example in spring or autumn, turn off the circuit breaker.

- The air conditioner always consumes a small amount of electricity even while it is not operating.



Adjusting the Airflow Rate

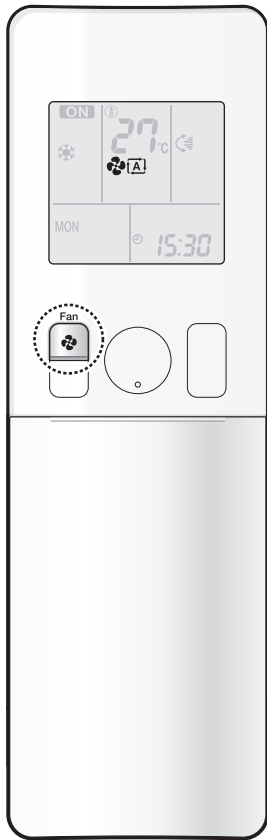



You can adjust the airflow rate to increase your comfort.

■ To adjust the airflow rate setting

▶ Press  .

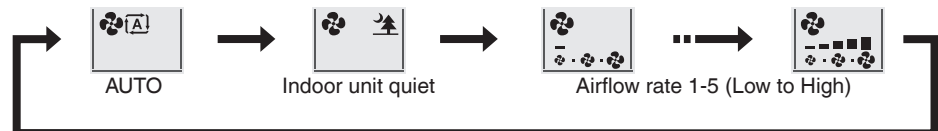
- Each pressing of  changes the airflow rate setting in sequence.



- When the airflow is set to “”, quiet operation starts and noise from the indoor unit will become quieter.
- In the quiet operation mode, the airflow rate is set to a weak level.
- In DRY operation, the airflow rate setting cannot be changed.
- At smaller airflow rates, the cooling effect is also smaller.



Adjusting the Airflow Direction

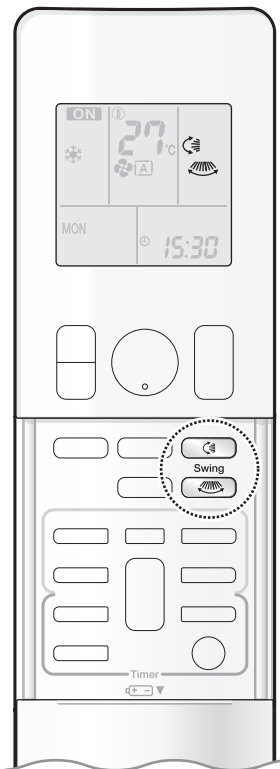

You can adjust the airflow direction to increase your comfort.

⚠ CAUTION

- Always use a remote controller to adjust the angles of the flaps and louvres.
 - If you attempt to move the flaps and louvres forcibly by hand when they are swinging, the mechanism may be damaged.
 - Inside the air outlet, a fan is rotating at a high speed.

■ To start auto swing

Up and down airflow direction

▶ Press  .

- “” appears on the LCD.
- The flaps (horizontal blades) will begin to swing.

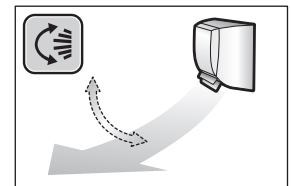

Right and left airflow direction



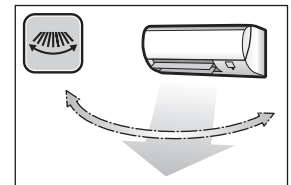

▶ Press  .

- “” appears on the LCD.
- The louvres (vertical blades) will begin to swing.



The 3-D airflow direction

▶ Press  and  .

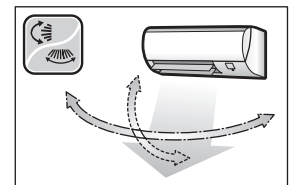

- “” and “” appear on the LCD.
- The flaps and louvres move in turn.
- To cancel 3-D airflow, press either  or  again. The flaps or louvres will stop moving.



■ To set the flaps or louvres at the desired position

- This function is effective while the flaps or louvres are in auto swing mode.

▶ Press  and  when the flap or louvres reach the desired position.

- In the 3-D airflow, the flaps and louvres move in turn.
- “” or “” disappears from the LCD.

NOTE

Notes on airflow direction setting

- The movable range of the flaps varies according to the operation mode.

Note on 3-D airflow

- Using 3-D airflow circulates cold air, which tends to collect at the bottom of the room, and hot air, which tends to collect near the ceiling, throughout the room, preventing areas of cold and hot developing.

Movable range of the flaps

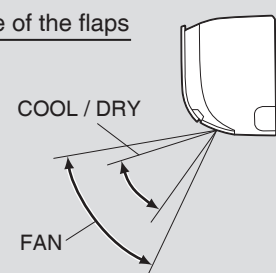



COMFORT AIRFLOW / INTELLIGENT EYE Operation

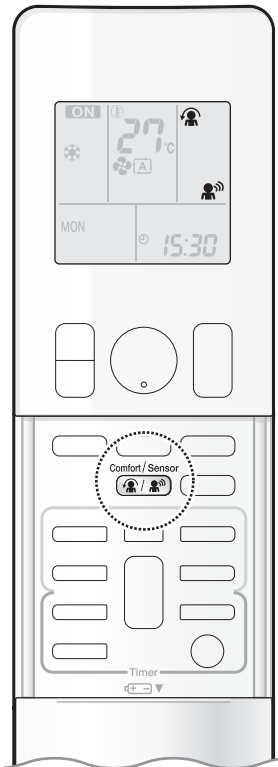

COMFORT AIRFLOW operation: The airflow direction is upward while in COOL and DRY operation. This function prevents cold air from blowing directly on the occupants in the room.

INTELLIGENT EYE operation: The INTELLIGENT EYE sensor detects human movement. If no one is in the room for more than 20 minutes, the operation automatically changes to energy saving operation.

⚠ CAUTION

- Do not place large objects near the INTELLIGENT EYE sensor. Also keep heating units and humidifiers outside the sensor's detection area. This sensor can detect undesirable objects.
- Do not hit or violently push the INTELLIGENT EYE sensor. This can lead to damage and malfunction.



■ To start

▶ Press  and select the desired mode.

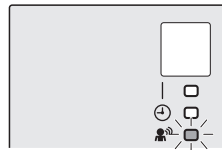
- Each time  is pressed, a different setting option appears on the LCD.
- When INTELLIGENT EYE is selected, the INTELLIGENT EYE lamp lights green.



Display

- By selecting “ ” from the following icons, the air conditioner will switch to COMFORT AIRFLOW operation combined with INTELLIGENT EYE operation.

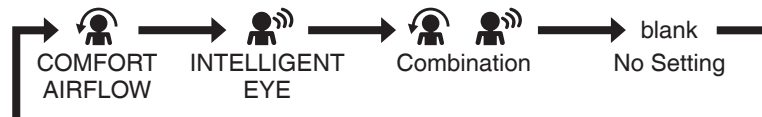

- When the flaps (horizontal blades) are swinging, selecting any of the modes above will cause the flaps (horizontal blades) to stop.

■ To cancel

▶ Press  until no icon is displayed.

- If the INTELLIGENT EYE operation was being used, the INTELLIGENT EYE lamp goes off.

INTELLIGENT EYE operation is useful for energy saving

■ People are detected in the sensing area.

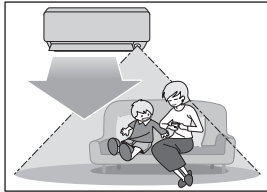

The air conditioner is in normal operation while the sensor is detecting human movement.

■ No people are detected in the sensing area.

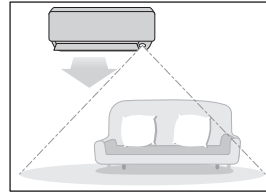

The air conditioner will switch to energy-saving mode after 20 minutes.

Energy saving operation

- If no presence detected in the room for 20 minutes, the energy saving operation will start, and the INTELLIGENT EYE lamp goes off. If human movement is detected again, the INTELLIGENT EYE lamp lights up and energy saving operation terminates.
- This operation changes the temperature by +2°C in COOL / +2°C in DRY operation from the set temperature. When the room temperature exceeds 30°C, the operation changes the temperature by +1°C in COOL / +1°C in DRY operation from the set temperature.
- This operation decreases the airflow rate slightly in FAN operation only.

NOTE

Note on COMFORT AIRFLOW operation

- The airflow rate will be set to AUTO. If the up and down airflow direction is selected, COMFORT AIRFLOW operation will be cancelled.

Notes on INTELLIGENT EYE operation

- Application range is as follows.

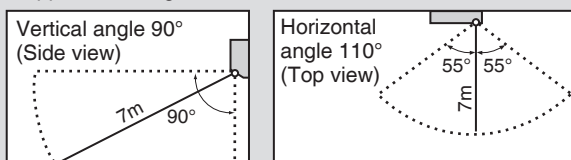

- The sensor may not detect moving objects further than 7m away. (Please see the application range)
- Sensor detection sensitivity changes according to the indoor unit location, the speed of passers-by, temperature range, etc.
- The sensor could also mistakenly detect pets, sunlight, fluttering curtains and light reflected off of mirrors as passers-by.
- NIGHT SET mode **▶Page 20** will not switch on during use of INTELLIGENT EYE operation.

Note on combination of COMFORT AIRFLOW operation and INTELLIGENT EYE operation

- The airflow rate will be set to AUTO. If the up and down airflow direction is selected, COMFORT AIRFLOW operation will be cancelled. Priority is given to the function of whichever button is pressed last.



POWERFUL Operation

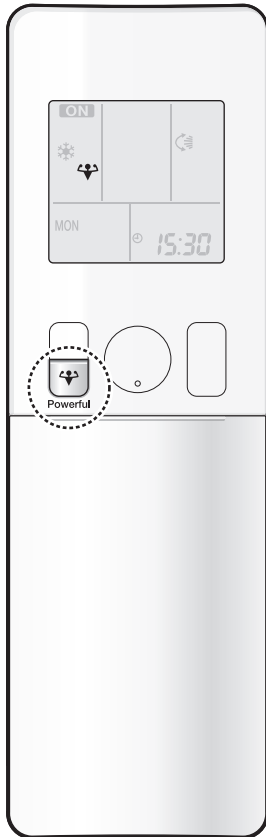

POWERFUL operation quickly maximises the cooling effect in any operation mode. In this mode, the air conditioner operates at maximum capacity.

■ To start

▶ Press  during operation.

- “” appears on the LCD.
- POWERFUL operation ends in 20 minutes. Then the system automatically operates again with the previous settings which were used before POWERFUL operation.



■ To cancel

▶ Press  again.

- “” disappears from the LCD.

NOTE

Notes on POWERFUL operation

- Pressing  causes the settings to be cancelled, and “” disappears from the LCD.
- POWERFUL operation will not increase the capacity of the air conditioner if the air conditioner is already in operation with its maximum capacity demonstrated.
 - **In COOL operation**
To maximise the cooling effect, the capacity of outdoor unit increases and the airflow rate becomes fixed at the maximum setting. The temperature and airflow settings cannot be changed.
 - **In DRY operation**
The temperature setting is lowered by 2.5°C and the airflow rate is slightly increased.
 - **In FAN operation**
The airflow rate is fixed at the maximum setting.
 - **When using priority room setting**
Refer to “Note for Multi System”. ▶ [Page 28](#)

Regarding the combination of POWERFUL and other operations

POWERFUL + COMFORT AIRFLOW	
POWERFUL + ECONO	Not available*
POWERFUL + OUTDOOR UNIT QUIET	

*Priority is given to the function of whichever button is pressed last.



ECONO / OUTDOOR UNIT QUIET Operation

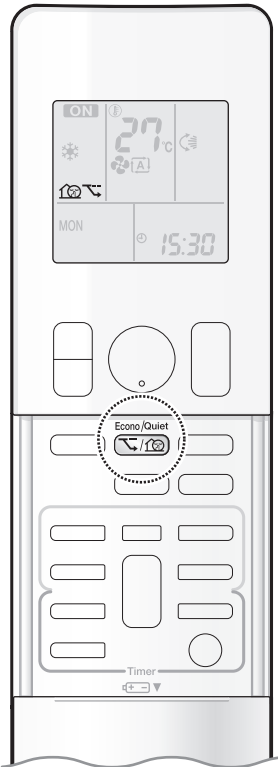

ECONO operation enables efficient operation by limiting the maximum power consumption.

This function is useful to prevent the circuit breaker from tripping when the unit operates alongside other appliances on the same circuit.

OUTDOOR UNIT QUIET operation lowers the noise level of the outdoor unit by changing the frequency and fan speed of the outdoor unit. This function is convenient during the night-time operation.

■ To start

▶ Press  and select the desired mode.

- Each time  is pressed, a different setting option appears on the LCD.





■ To cancel

▶ Press  until no icon is displayed.

NOTE

Notes on ECONO operation

- This operation is performed with lower power and therefore may not provide a sufficient cooling effect.
- Pressing  causes the settings to be cancelled, and “” disappears from the LCD.
- If the power consumption level is already low, switching to ECONO operation will not reduce the power consumption.

Notes on OUTDOOR UNIT QUIET operation

- If using a multi system, the OUTDOOR UNIT QUIET operation will work only when this function is set on all operated indoor units. However, if using priority room setting, refer to “**Note for Multi System**”. ▶ [Page 28](#)
- Even if the operation is stopped by using the remote controller or the indoor unit ON/OFF switch when using OUTDOOR UNIT QUIET operation, “” will remain displayed on the remote controller.
- OUTDOOR UNIT QUIET operation will not reduce the frequency nor fan speed if they already are operating at reduced levels.
- This operation is performed with lower power and therefore may not provide a sufficient cooling effect.

Possible combinations of ECONO / OUTDOOR UNIT QUIET operation and basic operations

	Operation mode		
	DRY	COOL	FAN
ECONO	✓	✓	—
OUTDOOR UNIT QUIET	—	✓	—



ON/OFF TIMER Operation

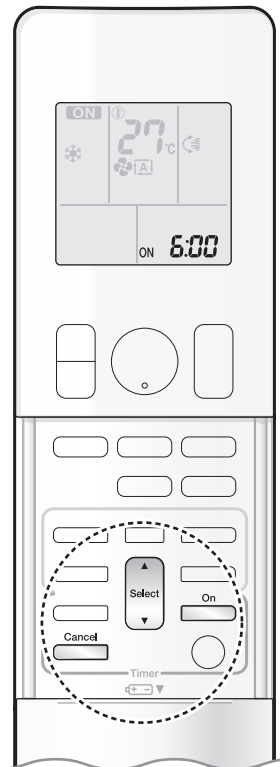

Timer functions are useful for automatically switching the air conditioner on or off at night or in the morning. You can also use the ON TIMER and OFF TIMER together.

[ON TIMER operation]

■ To set

- Check that the clock is correct.
If not, set the clock to the present time. ▶Page 11

1. Press .



“ 6:00 ” appears on the LCD.
“ ON ” blinks.

- “ ⌚ ” and day of the week disappear from the LCD.

2. Press until the time setting reaches the point you like.

- Each pressing of either button increases or decreases the time setting by 10 minutes. Holding down either button changes the setting rapidly.

3. Press again.

- “ ON ” and setting time appear on the LCD.
- The TIMER lamp lights orange.

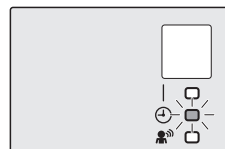

Display

■ To cancel

▶ Press .

- “ ON ” and setting time disappear from the LCD.
- “ ⌚ ” and day of the week appear on the LCD.
- The TIMER lamp goes off.

NOTE

Notes on TIMER operation

- When TIMER is set, the present time is not displayed.
- When using the ON/OFF TIMER to start/stop operation, the actual operation start/stop time may differ from the time set. (Maximum of about 10 minutes)

In the following cases, set the timer again.

- After the circuit breaker has turned off.
- After a power failure.
- After replacing the batteries in the remote controller.

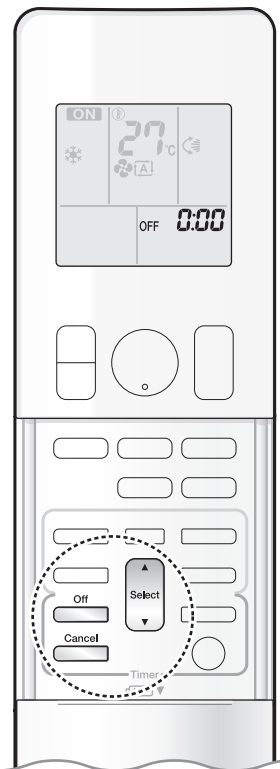

[OFF TIMER operation]

■ To set

- Check that the clock is correct.
If not, set the clock to the present time. ▶ Page 11

1. Press .



“ 0:00 ” appears on the LCD.
“ OFF ” blinks.

- “ ☀ ” and day of the week disappear from the LCD.

2. Press until the time setting reaches the point you like.

- Each pressing of either button increases or decreases the time setting by 10 minutes.
Holding down either button changes the time setting rapidly.

3. Press again.

- “ OFF ” and setting time appear on the LCD.
- The TIMER lamp lights orange.

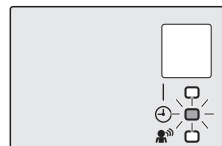

Display

■ To cancel

▶ Press .

- “ OFF ” and setting time disappear from the LCD.
- “ ☀ ” and day of the week appear on the LCD.
- The TIMER lamp goes off.

[ON/OFF TIMER combination]

■ To combine

- A sample setting for combining the 2 timers is shown below.

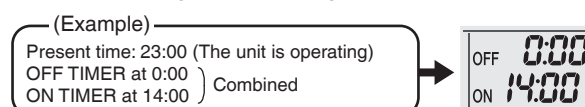

NOTE

NIGHT SET mode

- When the OFF TIMER is set, the air conditioner automatically adjusts the temperature setting (0.5°C up in COOL) to prevent excessive cooling during sleeping hours.



WEEKLY TIMER Operation

Up to 4 timer settings can be saved for each day of the week. This is convenient to adapt the WEEKLY TIMER to your family's life style.

■ Setting example of the WEEKLY TIMER

The same timer settings are used from Monday through Friday, while different timer settings are used for the weekend.

<p>[Monday]</p>	<p>Make timer settings for programmes 1-4. ▶Page 22</p> <p>Programme 1 Programme 2 Programme 3 Programme 4</p> <p>ON OFF ON OFF</p>
<p>[Tuesday to Friday]</p>	<p>Use the copy mode to make settings for Tuesday to Friday, because these settings are the same as those for Monday. ▶Page 24</p> <p>Programme 1 Programme 2 Programme 3 Programme 4</p> <p>ON OFF ON OFF</p>
<p>[Saturday]</p>	<p>No timer settings</p>
<p>[Sunday]</p>	<p>Make timer settings for programmes 1-4. ▶Page 22</p> <p>Programme 1 Programme 2 Programme 3 Programme 4</p> <p>ON OFF OFF ON</p>

- Up to 4 reservations per day and 28 reservations per week can be set using the WEEKLY TIMER. The effective use of the copy mode simplifies timer programming.
- The use of ON-ON-ON-ON settings, for example, makes it possible to schedule operating mode and set temperature changes. Furthermore, by using OFF-OFF-OFF-OFF settings, only the turn off time of each day can be set. This will turn off the air conditioner automatically if you forget to turn it off.

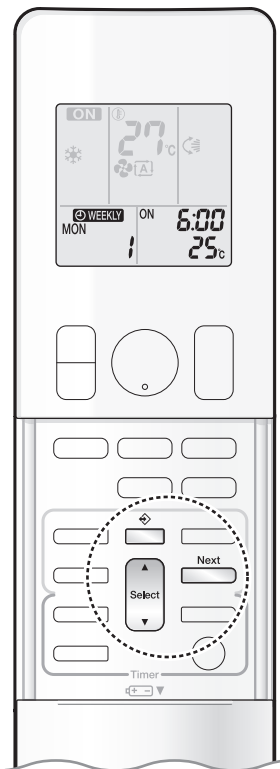

■ To use WEEKLY TIMER operation

Setting mode

- Make sure the day of the week and time are set.
If not, set the day of the week and time. ▶Page 11

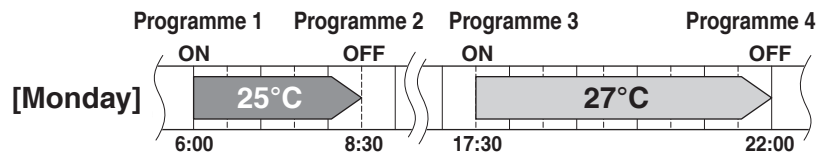

Setting Displays

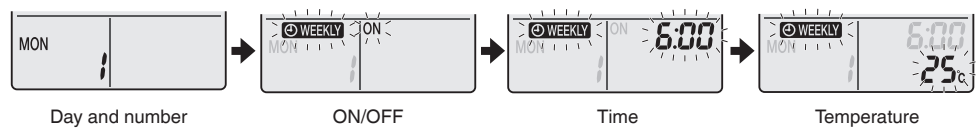

1. Press .

- The day of the week and the reservation number of the current day will be displayed.
- 1 to 4 settings can be made per day.

2. Press to select the desired day of the week and reservation number.

- Pressing  changes the reservation number and the day of the week.

3. Press .

- The day of the week and reservation number will be set.
- “ WEEKLY” and “ON” blink.

4. Press to select the desired mode.

- Pressing  changes the “ON” or “OFF” setting in sequence.



- In case the reservation has already been set, selecting “blank” deletes the reservation.
- Proceed to **STEP 9** if “blank” is selected.
- To return to the day of the week and reservation number setting, press .

5. Press .

- The ON/OFF TIMER mode will be set.
- “ WEEKLY” and the time blink.



WEEKLY TIMER Operation

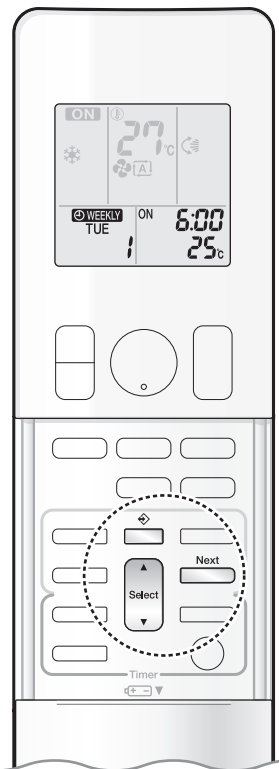

6. Press to select the desired time.

- The time can be set between 0:00 and 23:50 in 10-minute intervals.
- To return to the ON/OFF TIMER mode setting, press .
- Proceed to **STEP 9** when setting the OFF TIMER.

7. Press .

- The time will be set.
- “ WEEKLY” and the temperature blink.

8. Press to select the desired temperature.

- The temperature can be set between 10°C and 32°C.
COOL: The unit operates at 18°C even if it is set to 10 to 17°C. 
- To return to the time setting, press .
- The set temperature is only displayed when the mode setting is on.

9. Press .

- The temperature will be set and go to the next reservation setting.
- The temperature is set while in ON TIMER operation, and the time is set while in OFF TIMER operation.
- The next reservation screen will appear.
- To continue further settings, repeat the procedure from **STEP 4**.

10. Press to complete the setting.

- Be sure to direct the remote controller toward the indoor unit and check for a receiving tone and blinking of the OPERATION lamp.
- “ WEEKLY” appears on the LCD and WEEKLY TIMER operation is activated.
- The TIMER lamp lights orange.

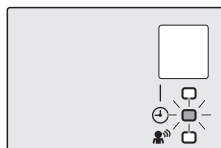





Display

- A reservation made once can be easily copied and the same settings used for another day of the week. Refer to **Copy mode** . 

NOTE

Notes on WEEKLY TIMER operation

- Do not forget to set the clock on the remote controller first. 
- The day of the week, ON/OFF TIMER mode, time and set temperature (only for ON TIMER mode) can be set with the WEEKLY TIMER. Other settings for the ON TIMER are based on the settings just before the operation.
- WEEKLY TIMER and ON/OFF TIMER operation cannot be used at the same time. The ON/OFF TIMER operation has priority if it is set while WEEKLY TIMER is still active. The WEEKLY TIMER will enter the standby state, and “ WEEKLY” will disappear from the LCD. When the ON/OFF TIMER is up, the WEEKLY TIMER will automatically become active.
- Only the time and set temperature with the WEEKLY TIMER are sent with the . Set the WEEKLY TIMER only after setting the operation mode, the airflow rate and the airflow direction ahead of time.
- Turning off the circuit breaker, power failure, and other similar events will render operation of the indoor unit's internal clock inaccurate. Reset the clock. 
-  can be used only for the time and temperature settings. It cannot be used to go back to the reservation number.

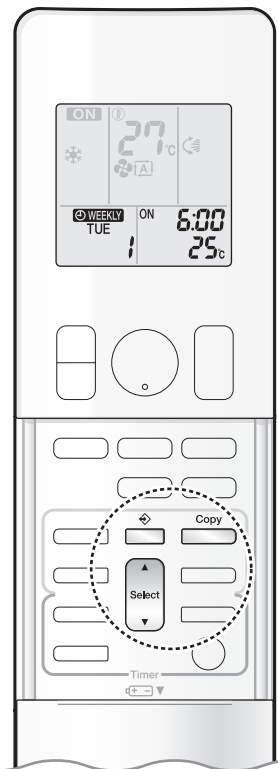

Copy mode

- A reservation made once can be copied to another day of the week. The whole reservation of the selected day of the week will be copied.

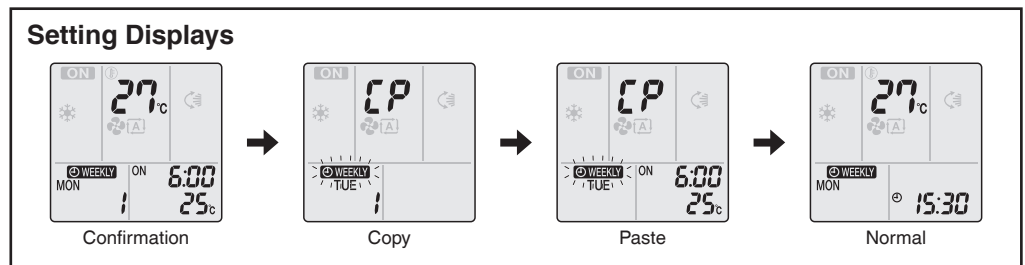
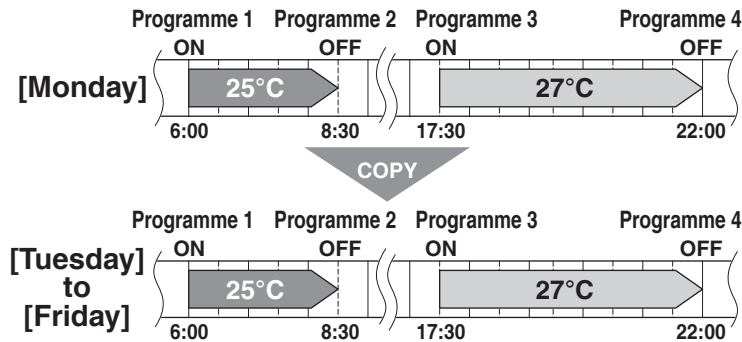

1. Press .

2. Press to confirm the day of the week to be copied.

3. Press .

- The whole reservation of the selected day of the week will be copied.

4. Press to select the destination day of the week.

5. Press .

- The reservation will be copied to the selected day of the week. The whole reservation of the selected day of the week will be copied.
- To continue copying the settings to other days of the week, repeat **STEP 4** and **STEP 5**.

6. Press to complete the setting.

- “ WEEKLY” appears on the LCD and WEEKLY TIMER operation is activated.

NOTE

Note on COPY MODE

- The entire reservation of the source day of the week is copied in the copy mode.

In the case of making a reservation change for any day of the week individually after copying the content of weekly reservations, press and change the settings in the steps of **Setting mode** . [▶Page 22](#)



WEEKLY TIMER Operation

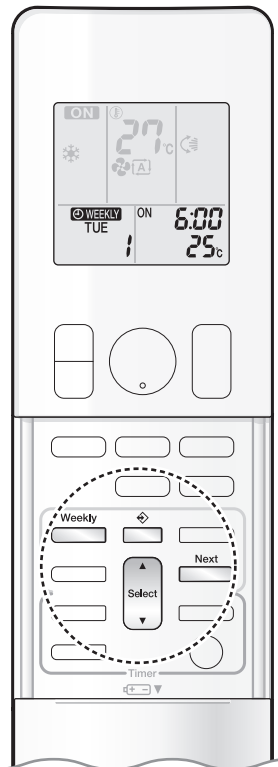

■ Confirming a reservation

- The reservation can be confirmed.

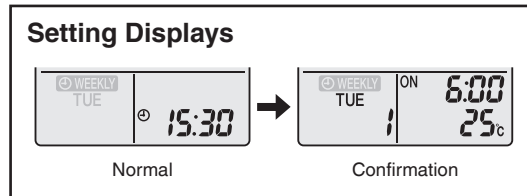

1. Press .

- The day of the week and the reservation number of the current day will be displayed.

2. Press to select the day of the week and the reservation number to be confirmed.

- Pressing displays the reservation details.
- To change the confirmed reserved settings, select the reservation number and press . The mode is switched to setting mode. Proceed to **Setting mode STEP 4.** [▶Page 22](#)

3. Press to exit the confirmation mode.

- “ ” appears on the LCD and WEEKLY TIMER operation is activated.
- The TIMER lamp lights orange.

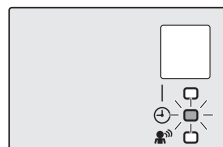

Display

■ To deactivate WEEKLY TIMER operation

▶ Press while “ ” is displayed on the LCD.

- “ ” disappears from the LCD.
- The TIMER lamp goes off.
- To reactivate the WEEKLY TIMER operation, press again.
- If a reservation deactivated with is activated once again, the last reservation mode will be used.

NOTE

- If not all the reservation settings are reflected, deactivate the WEEKLY TIMER operation once. Then press again to reactivate the WEEKLY TIMER operation.

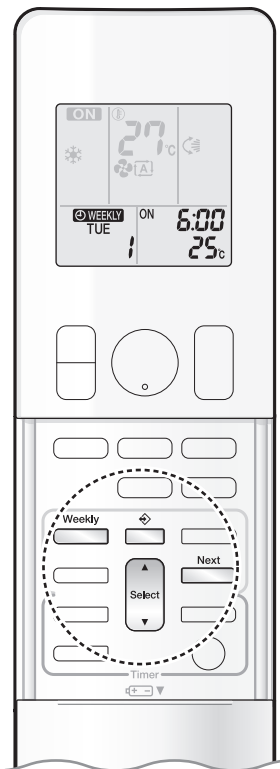

■ To delete a reservation

An individual reservation

1. Press  .

- The day of the week and the reservation number will be displayed.

2. Press  **to select the day of the week and the reservation number to be deleted.**

3. Press  .

- “ WEEKLY” and “ON” or “OFF” blink.

4. Press  **until no icon is displayed.**

- Pressing  changes the ON/OFF TIMER mode in sequence.
- Selecting “blank” will cancel any reservation you may have.

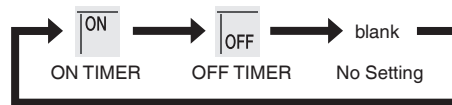

Pressing  puts the sequence in reverse.

5. Press  .

- The selected reservation will be deleted.

6. Press  .

- If there are still other reservations, WEEKLY TIMER operation will be activated.

Reservations for each day of the week

- This function can be used for deleting reservations for each day of the week.
- It can be used while confirming or setting reservations.

1. Press  .

- The day of the week and the reservation number will be displayed.

2. Press  **to select the day of the week to be deleted.**

3. Hold  **for about 5 seconds.**

- The reservation of the selected day of the week will be deleted.

4. Press  .

- If there are still other reservations, WEEKLY TIMER operation will be activated.

All reservations

▶ Hold  **for about 5 seconds with the normal display.**

- Be sure to direct the remote controller toward the indoor unit and check for a receiving tone.
- This operation cannot be used for the WEEKLY TIMER setting display.
- All reservations will be deleted.



Wireless LAN connection

Web site: <http://www.daikinthal.com/product/dmobile>

For information on the latest version of Wireless LAN control, please see the web site above.

■ Application software installation

- Before downloading the application software for installing, please read “Configuration” on **▶Page 7**.

▶ For Android Phones

- 1) Open the [Google Play].
- 2) Search using the application name: [DAIKIN Mobile Controller].
- 3) Follow the directions on the screen to install.

▶ For iPhones

- 1) Open the [App Store].
- 2) Search using the application name: [DAIKIN Mobile Controller].
- 3) Follow the directions on the screen to install.

■ Simple Wireless LAN Connection Setting

- The setup is simple if there is a [WPS] button on the router (Wireless LAN access point).

1. Check that the [RUN] lamp is blinking.

2. Push the [WPS] button on the router (Wireless LAN access point).

- Operation of the [WPS] differs according to the router (Wireless LAN access point).
- Please refer to the documentation that comes with your router for more information. Does your router have a [WPS] button?
For more information, see the manual of your router.

3. Push the [SETUP] button on the Wireless LAN connecting adapter for approximately 2 seconds.

- The [RUN] lamp on the Wireless LAN connecting adapter blinks more quickly. When the Wireless LAN connecting adapter and the router (Wireless LAN access point) are connected, this lamp lights. If you fail to connect, please try again from step 1 of “Simple Wireless LAN Connection Setting”. (It may not be possible to make the “Simple Wireless LAN Connection Setting”, depending on compatibility with the router.)

4. After connecting the Wireless LAN connecting adapter to the router, the user will be able to detect the Wireless LAN connecting adapter via the DAIKIN Mobile Controller application.

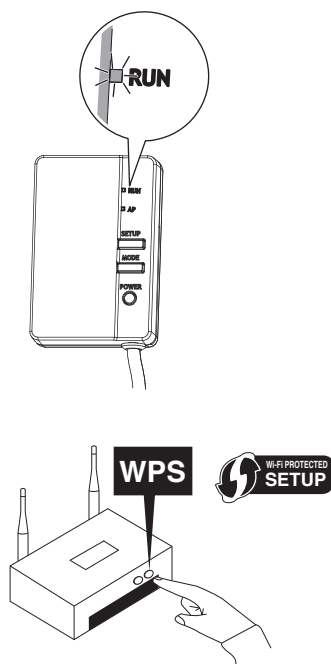

NOTE

Notes on Wireless LAN connecting adapter

- In case simple wireless connection setting cannot be completed successfully, please refer to the web site for other connection setting methods.
- Some models already have the Wireless LAN adapter installed in the indoor unit **▶Page 6**

Note for Multi System

A multi system has one outdoor unit connected to multiple indoor units.

■ Selecting the operation mode

When the priority room setting is active but the set unit is not operating or when the priority room setting is inactive

When more than one indoor unit is operating, priority is given to the first unit that was turned on.

In this case, set the units that are turned on later to the same operation mode as the first unit.

Otherwise, they will enter the standby state, and the OPERATION lamp will blink; this does not indicate malfunction.

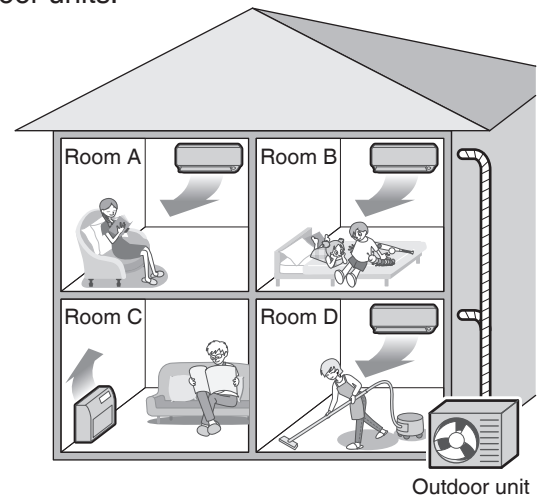

NOTE

Notes on operation mode for a multi system

- COOL, DRY and FAN operation may be used at the same time.

With the priority room setting active

Refer to “**Priority room setting**” on the next page.

■ NIGHT QUIET mode (Available only for COOL operation)

NIGHT QUIET mode requires initial programming during installation. Please consult your retailer or dealer for assistance.

NIGHT QUIET mode reduces the operation noise of the outdoor unit during the night-time hours to prevent annoyance to neighbours.

- NIGHT QUIET mode is activated when the temperature drops 6°C or more below the highest temperature recorded that day.
 - When the temperature difference between the current outdoor temperature and the maximum outdoor temperature becomes less than 4°C, this function will be cancelled.
- NIGHT QUIET mode slightly reduces the cooling efficiency of the unit.

■ OUTDOOR UNIT QUIET operation

Refer to “**OUTDOOR UNIT QUIET operation**”. [▶Page 18](#)

When the priority room setting is active but the set unit is not operating or when the priority room setting is inactive

When using the OUTDOOR UNIT QUIET operation feature with a multi system, set all indoor units to OUTDOOR UNIT QUIET operation using their remote controllers.

When cancelling OUTDOOR UNIT QUIET operation, simply cancel the mode on one of the operating indoor units using their remote controller.

However OUTDOOR UNIT QUIET operation will remain displayed on the remote controllers for the other rooms.

We recommend you cancel operation in all rooms using their remote controllers.

With the priority room setting active

Refer to “**Priority room setting**” on the next page.

Note for Multi System

■ Priority room setting

The priority room setting requires initial programming during installation. Please consult your authorized dealer for assistance. The room designated as the priority room takes priority in the following situations.

Operation mode priority

- As the operation mode of the priority room takes precedence, you can select a different operation mode from other rooms.

[Example]

- Room A is the priority room in this example.

When COOL operation is selected in room A while operating the following modes in room B, C and D:

Operation mode in room B, C and D	Status of room B, C and D when the unit in room A is in COOL operation
COOL or DRY or FAN	The current operation mode is maintained.

Priority when POWERFUL operation is used

[Example]

- Room A is the priority room in this example.

The indoor units in rooms A, B, C and D are all operating. If the unit in room A enters POWERFUL operation, operation capacity will be concentrated in room A. In such a case, the cooling efficiency of the units in room B, C and D may be slightly reduced.

Priority when OUTDOOR UNIT QUIET operation is used

[Example]

- Room A is the priority room in this example.

Just by setting the unit in room A to QUIET operation, the air conditioner starts OUTDOOR UNIT QUIET operation. You do not have to set all the indoor units in operation to OUTDOOR UNIT QUIET operation.

Care and Cleaning

⚠ CAUTION

- Before cleaning, be sure to stop the operation and turn off the circuit breaker.
- Do not touch the aluminum fins of the indoor unit. If you touch those parts, this may cause an injury.

■ Quick reference

Cleaning parts

Front panel

- Wipe it with a soft damp cloth.
- Only neutral detergent may be used.

If dirty

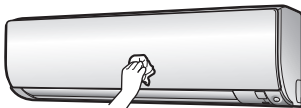

Air filter

- Vacuum dust or wash the filter.

Once every 2 weeks

▶ Page 31

Indoor unit, outdoor unit and remote controller

- Wipe them with a soft cloth.

If dirty

Dust collection filter (PM2.5)

To purchase, contact the dealer where you bought the air conditioner.

Item	Part No.
Dust collection filter (PM2.5) – without frame (set of 2)	BAFP046A41

Dust collection filter (PM2.5)

- No cleaning is required. Please replace the filter every 6 months. ▶ Page 32

Notes on cleaning

For cleaning, do not use any of the following:

- Water hotter than 40°C
- Volatile liquid such as benzene, petrol and thinner
- Polishing compounds
- Rough materials such as a scrubbing brush



Care and Cleaning

■ Air filter

1. Open the front panel.

- Hold the front panel by the sides and open it.

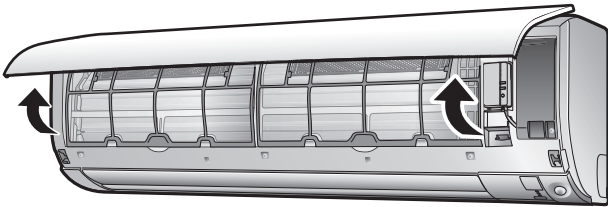

2. Pull out the air filters.

- Push the filter tab at the centre of each air filter a little upwards, then pull it down.

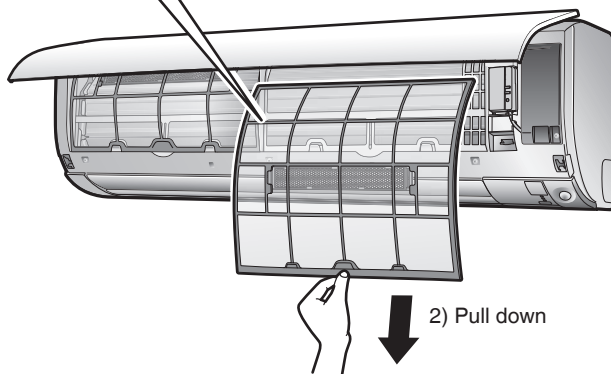
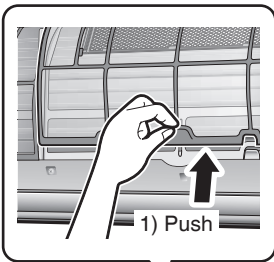

3. Wash the air filters with water or clean them with vacuum cleaner.

- It is recommended to clean the air filters every 2 weeks.

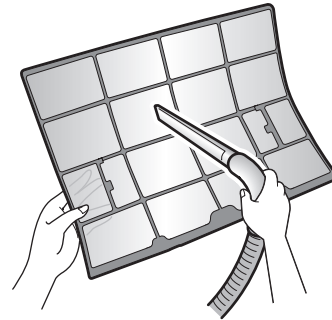

If the dust does not come off easily

- Wash the air filters with neutral detergent thinned with lukewarm water, then dry them up in the shade.

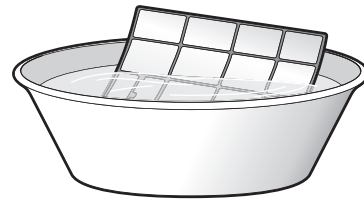

4. Reattach the filters.

5. Close the front panel slowly.

- Press the panel at both sides and the centre.

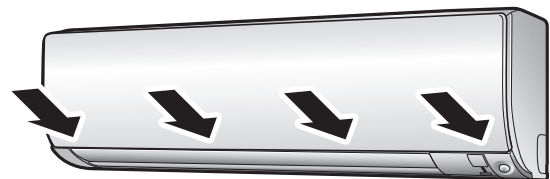

- Make sure that the front panel is securely fixed.

■ Dust collection filter (PM2.5)

Attaching

1. Open the front panel and pull out the air filters. ▶Page 31

2. Insert dust collection filters (PM2.5).

- Check that the filters are inserted securely under the tabs.

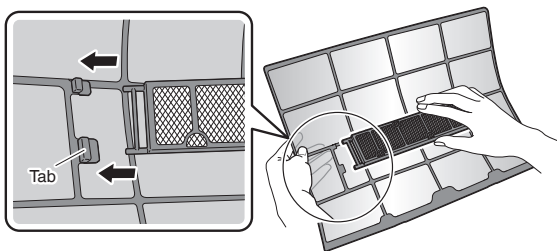

Cleaning and Replacement

1. Open the front panel and pull out the air filters. ▶Page 31

2. Take off dust collection filters (PM2.5).

- Hold the recessed parts of the frame and unhook the 4 tabs.
- Remove the filters from the tabs.

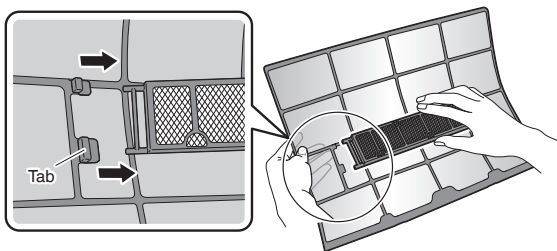

3. Clean or replace dust collection filters (PM2.5).

[Cleaning]

- Do not wash the filters as this will reduce their efficiency.
- It is recommended to replace it once **every 6 months**.

[Replacement]

Remove the filter from the filter frame and prepare a new one.

- Do not throw away the filter frame. Reuse the filter frame when replacing dust collection filter (PM2.5).



- When attaching the filter, check that the filter is properly set in the tabs.

4. Set the filters as they were and close the front panel.

- Press the front panel at both sides and the center.



NOTE

- Operation with dirty filters:
 - cannot deodorise the air,
 - cannot clean the air,
 - results in poor cooling,
 - may cause odour.
- Dispose of old filters as non-flammable waste.

Care and Cleaning

■ Prior to a long period of non-use

1. Operate the FAN mode for several hours on a fine day to dry out the inside.

- 1) Press  and select “”.
- 2) Press  and start the operation.

2. After operation stops, turn off the circuit breaker for the room air conditioner.

3. Clean the air filters and reattach them. 

4. To prevent battery leakage, take out the batteries from the remote controller.

■ We recommend periodical maintenance

- In certain operating conditions, the inside of the air conditioner may get foul after several seasons of use, resulting in poor performance. It is recommended to have periodical maintenance by a specialist in addition to regular cleaning by the user.
- For specialist maintenance, please contact the dealer where you bought the air conditioner.
- The maintenance cost must be borne by the user.

FAQ

Indoor unit

The flaps do not start swinging immediately.

- The air conditioner is adjusting the position of the flaps. The flaps will start moving soon.

Operation does not start soon.

- **When any direct operation button was pressed soon after operation was stopped.**
- **When the mode was reselected.**
 - This is to protect the air conditioner. You should wait for about 3 minutes.

Wireless LAN connecting adapter

The LEDs blink through the front panel.

- The lamp can be disabled via the mobile application. [▶ Page 7](#)

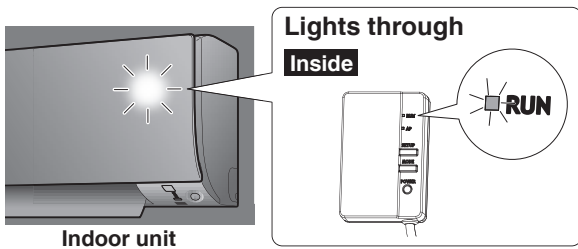

Different sounds are heard.

- **A sound like flowing water**
 - This sound is generated because the refrigerant in the air conditioner is flowing.
 - This is a pumping sound of the water in the air conditioner and can be heard when the water is pumped out from the air conditioner during COOL or DRY operation.
 - The refrigerant flows in the air conditioner even if the air conditioner is not working when the indoor units in other rooms are in operation.
- **Ticking sound**
 - This sound is generated when the cabinet and frame of the air conditioner slightly expand or shrink as a result of temperature changes.
- **Clicking sound during operation or idle time**
 - This sound is generated when the refrigerant control valves or the electrical parts operate.
- **Clopping sound**
 - This sound is heard from the inside of the air conditioner when the exhaust fan is activated while the room doors are closed. Open the window or turn off the exhaust fan.

Outdoor unit

The outdoor unit emits water.

- **In COOL or DRY operation**
 - Moisture in the air condenses into water on the cool surface of the outdoor unit piping and drips.

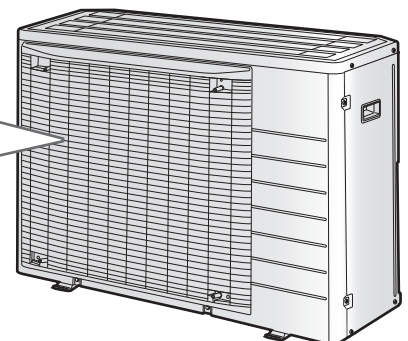

*The appearance of the outdoor unit may differ between different models.

Troubleshooting

Air conditioner

Before making an inquiry or a request for repair, please check the following.
If the problem persists, consult your dealer.



Not a problem

This case is not a problem.



Check

Please check again before requesting repairs.

The air conditioner does not operate

Case	Description / what to check
OPERATION lamp is off.	<ul style="list-style-type: none"> • Has the circuit breaker been tripped or the fuse blown? • Is there a power failure? • Are batteries set in the remote controller?
OPERATION lamp is blinking.	<ul style="list-style-type: none"> • Turn off the power with the circuit breaker and restart operation with the remote controller. If the OPERATION lamp is still blinking, check the error code and consult your dealer. ▶ Page 38

The air conditioner suddenly stops operating

Case	Description / what to check
OPERATION lamp is on.	<ul style="list-style-type: none"> • To protect the system, the air conditioner may stop operating after sudden large voltage fluctuations. It automatically resumes operation in about 3 minutes.
OPERATION lamp is blinking.	<ul style="list-style-type: none"> • Is there anything blocking the air inlet or air outlet of the indoor unit or outdoor unit? Stop operation and after turning off the circuit breaker, remove the obstruction. Then restart operation with the remote controller. If the OPERATION lamp is still blinking, check the error code and consult your dealer. ▶ Page 38 • Are operation modes all the same for indoor units connected to the outdoor unit in the multi system? If not, set all indoor units to the same operation mode and confirm that the lamps blink. • If the lamps stop blinking after the above steps, there is no malfunction.

The air conditioner does not stop operating

Case	Description / what to check
The air conditioner continues operating even after operation is stopped.	<ul style="list-style-type: none"> <ul style="list-style-type: none"> ■ Immediately after the air conditioner is stopped <ul style="list-style-type: none"> • The outdoor unit fan continues rotating for about another 1 minute to protect the system. ■ While the air conditioner is not in operation <ul style="list-style-type: none"> • When the outdoor temperature is high, the outdoor unit fan may start rotating to protect the system.

The room does not cool down

Case	Description / what to check
Air does not come out.	<ul style="list-style-type: none"> <ul style="list-style-type: none"> ■ When the air conditioner operates immediately after the circuit breaker is turned on <ul style="list-style-type: none"> • The air conditioner is preparing to operate. Wait for about 3 to 15 minutes.
Air does not come out / Air comes out.	<ul style="list-style-type: none"> <ul style="list-style-type: none"> ■ Is the airflow rate setting appropriate? <ul style="list-style-type: none"> • Is the airflow rate setting low, such as "Indoor unit quiet" or "Airflow rate 1"? Increase the airflow rate setting. ■ Is the set temperature appropriate? ■ Is the adjustment of the airflow direction appropriate?
Air comes out.	<ul style="list-style-type: none"> <ul style="list-style-type: none"> • Is there any furniture directly under or beside the indoor unit? • Is the air conditioner in ECONO operation or OUTDOOR UNIT QUIET operation? ▶ Page 18 • Are the air filters dirty? • Is there anything blocking the air inlet or air outlet of the indoor unit or outdoor unit? • Is a window or door open? • Is an exhaust fan turning?

Air conditioner

Mist comes out

Case	Description / what to check
Mist comes out of the indoor unit.	<input checked="" type="checkbox"/> • This happens when the air in the room is cooled into mist by the cold airflow during COOL or other operation.

Remote controller

Case	Description / what to check
The unit does not receive signals from the remote controller or has a limited operating range.	<input checked="" type="checkbox"/> • The batteries may be exhausted. Replace both batteries with new dry batteries AAA.LR03 (alkaline). For details, refer to “ Preparation Before Operation ”. ▶Page 10 <input checked="" type="checkbox"/> • Signal communication may be disabled if an electronic-starter-type fluorescent lamp (such as inverter-type lamps) is in the room. Consult your dealer if that is the case. <input checked="" type="checkbox"/> • The remote controller may not function correctly if the transmitter is exposed to direct sunlight.
LCD is faint, is not working, or the display is erratic.	<input checked="" type="checkbox"/> • The batteries may be exhausted. Replace both batteries with new dry batteries AAA.LR03 (alkaline). For details, refer to “ Preparation Before Operation ”. ▶Page 10
The LCD is blinking and the remote controller cannot be operated.	<input checked="" type="checkbox"/> • Battery power has run out. Replace both batteries at the same time with new size AAA.LR03 (alkaline) batteries. Leaving exhausted batteries in the remote controller can result in injury due to battery leakage, rupturing or heating, or lead to equipment failure. (Even when the LCD is blinking, the OFF button remains functional.)
Other electric devices start operating.	<input checked="" type="checkbox"/> • If the remote controller activates other electric devices, move them away or consult your dealer.

Air has an odour

Case	Description / what to check
The air conditioner gives off an odour.	<input checked="" type="checkbox"/> • The room odour absorbed in the unit is discharged with the airflow. We recommend you to have the indoor unit cleaned. Please consult your dealer.

Others

Case	Description / what to check
The air conditioner suddenly starts behaving strangely during operation.	<input type="checkbox"/> • The air conditioner may malfunction due to lightning or radio. If the air conditioner malfunctions, turn off the power with the circuit breaker and restart the operation with the remote controller.
The ON/OFF TIMER does not operate according to the settings.	<input checked="" type="checkbox"/> • Check if the ON/OFF TIMER and the WEEKLY TIMER are set to the same time. Change or deactivate the settings in the WEEKLY TIMER. ▶Page 21

NOTE

Notes on the operating conditions



- If operation continues under any conditions other than those listed in the table,
 - A safety device may activate to stop the operation. (With a multi connection in COOL operation, the safety device may work to stop the operation of the outdoor unit only.)
 - Dew may form on the indoor unit and drip from it when COOL or DRY operation is selected.

Mode	Operating conditions
COOL / DRY	Outdoor temperature: 10-46°C Indoor temperature: 18-32°C Indoor humidity: 80% max.

Troubleshooting

Wireless LAN connecting adapter

The following table provides brief descriptions of how to handle trouble or uncertainties when you install the Wireless LAN connecting adapter or make connection setting. Refer to the FAQ on our web site for more details.

When this happens	Explanation and where to check
None of the LEDs light.	 <ul style="list-style-type: none"> • Try to operate the unit with the infrared remote controller. • Turn off the air conditioner and restart it. • Make sure the LEDs are not disabled in the application. • Check the installation. • Check that the power of the Wireless LAN connecting adapter is ON by pressing the [POWER] button on the adapter.
The Wireless LAN connecting adapter is not visible on the unit overview screen (“HOME” screen) after the Wireless LAN connecting adapter has been configured.	 <ul style="list-style-type: none"> • Check that the power is on. • Check that the [RUN] lamp is lit. • If the [RUN] lamp is blinking, retry to connect the Wireless LAN connecting adapter to the Wireless network. Make sure the Wireless LAN connecting adapter is close enough to the router (Wireless LAN access point). • If the [RUN] lamp is lit, make sure that the smartphone or tablet is connected to the same Wireless LAN network as Wireless LAN connecting adapter.
None of the above work.	 <ul style="list-style-type: none"> • Refer to the FAQ on: http://www.daikinthal.com/product/dmobile

For instructions about how to operate the DAIKIN Mobile Controller application, please refer to the operation manual at <http://www.daikinthal.com/product/dmobile>

■ Call your dealer immediately

WARNING

When an abnormality (such as a burning smell) occurs, stop operation and turn off the circuit breaker.

- Continued operation in an abnormal condition may result in problems, electric shock or fire.
- Consult the dealer where you bought the air conditioner.

Do not attempt to repair or modify the air conditioner by yourself.

- Incorrect work may result in electric shock or fire.
- Consult the dealer where you bought the air conditioner.

If one of the following symptoms takes place, call your dealer immediately.

- The power cord is abnormally hot or damaged.
- An abnormal sound is heard during operation.
- The circuit breaker, a fuse, or the earth leakage circuit breaker cuts off the operation frequently.
- A switch or a button often fails to work properly.
- There is a burning smell.
- Water leaks from the indoor unit.

Turn off the circuit breaker and call your dealer.



■ After a power failure

- The air conditioner automatically resumes operation in about 3 minutes. Please wait for a while.

■ Lightning

- If there is a risk lightning could strike in the neighbourhood, stop operation and turn off the circuit breaker to protect the system.

■ Disposal requirements

- Dismantling of the unit, handling of the refrigerant, oil and other parts, should be done in accordance with the relevant local and national regulations.

Troubleshooting

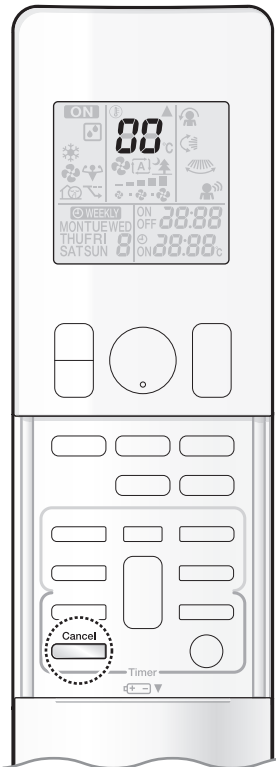

■ Fault diagnosis by remote controller

- In case the air conditioner is malfunctioning, you can check the error code via the remote controller before consulting with service personnel and informing them of the malfunction code.

1. When  is held down for about 5 seconds, “00” blinks in the temperature display section.

2. Press  repeatedly until a long beep is produced.

- The code indication changes as shown below, and notifies you with a long beep.

	CODE	MEANING
SYSTEM	00	NORMAL
	UA	INDOOR-OUTDOOR UNIT COMBINATION FAULT
	U0	REFRIGERANT SHORTAGE
	U2	DROP VOLTAGE OR MAIN CIRCUIT OVERVOLTAGE
	U4	FAILURE OF TRANSMISSION (BETWEEN INDOOR UNIT AND OUTDOOR UNIT)
INDOOR UNIT	A1	INDOOR PCB DEFECTIVENESS
	A5	HIGH PRESSURE CONTROL OR FREEZE-UP PROTECTOR
	A6	FAN MOTOR FAULT
	C4	FAULTY HEAT EXCHANGER TEMPERATURE SENSOR
	C9	FAULTY SUCTION AIR TEMPERATURE SENSOR
OUTDOOR UNIT	E1	CIRCUIT BOARD FAULT
	E5	OL STARTED
	E6	FAULTY COMPRESSOR START UP
	E7	DC FAN MOTOR FAULT
	E8	OVERCURRENT INPUT
	F3	HIGH TEMPERATURE DISCHARGE PIPE CONTROL
	F6	HIGH PRESSURE CONTROL (IN COOLING)
	H0	SENSOR FAULT
	H6	OPERATION HALT DUE TO FAULTY POSITION DETECTION SENSOR
	H8	DC CURRENT SENSOR FAULT
	H9	FAULTY SUCTION AIR TEMPERATURE SENSOR
	J3	FAULTY DISCHARGE PIPE TEMPERATURE SENSOR
	J6	FAULTY HEAT EXCHANGER TEMPERATURE SENSOR
	L3	ELECTRICAL PARTS HEAT FAULT
	L4	HIGH TEMPERATURE AT INVERTER CIRCUIT HEATSINK
L5	OUTPUT OVERCURRENT	
P4	FAULTY INVERTER CIRCUIT HEATSINK TEMPERATURE SENSOR	

NOTE

- A short beep indicate non-corresponding codes.
- To cancel the code display, hold  down for about 5 seconds. The code display also clears if no button is pressed for 1 minute.

Quick Reference

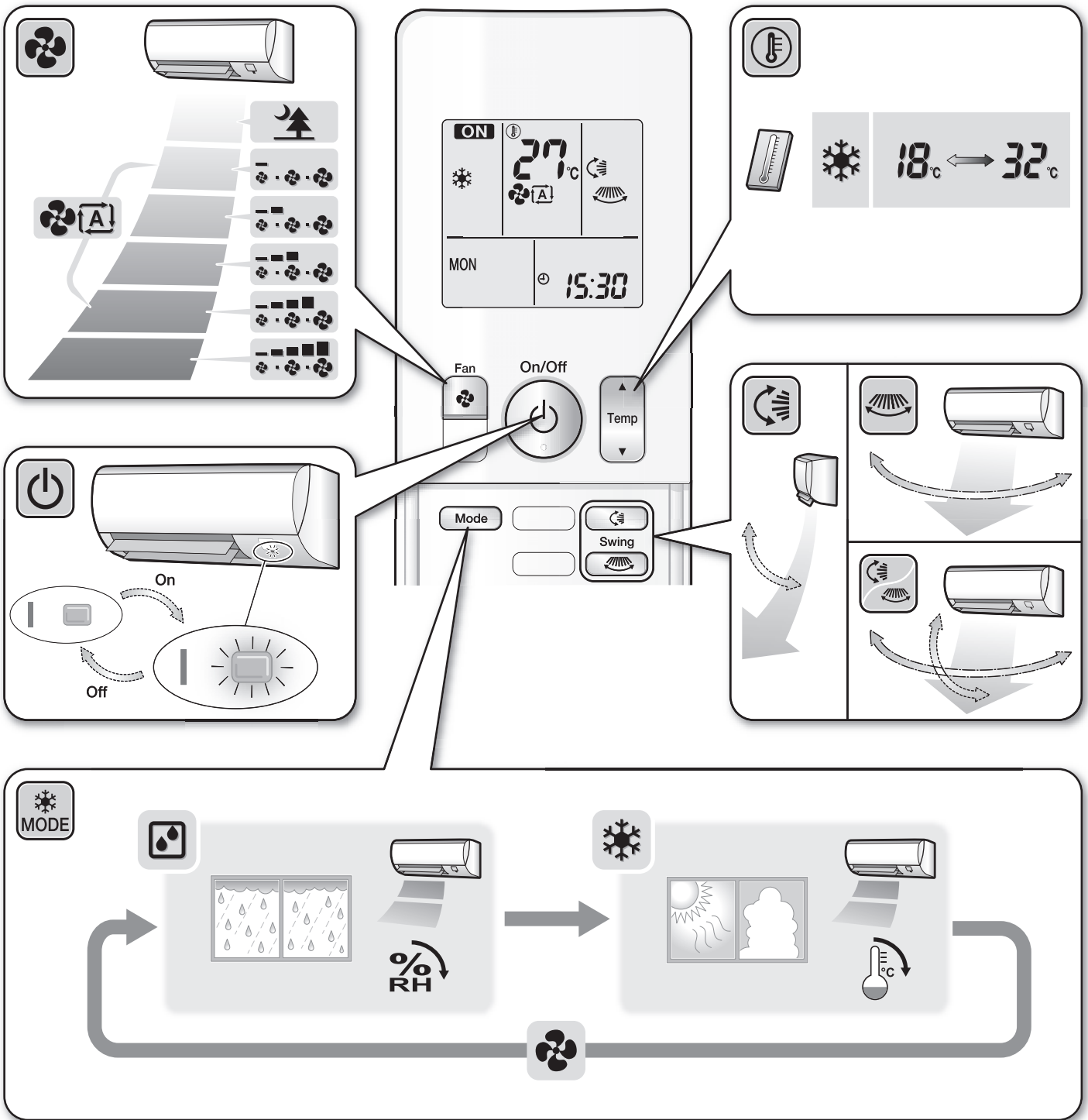

DAIKIN INDUSTRIES, LTD.

Head office:
 Umeda Center Bldg., 2-4-12, Nakazaki-Nishi,
 Kita-ku, Osaka, 530-8323 Japan

Tokyo office:
 JR Shinagawa East Bldg., 2-18-1, Konan,
 Minato-ku, Tokyo, 108-0075 Japan
<http://www.daikin.com>



The two-dimensional bar code is
 a manufacturing code.

3P440286-4D M19N016 (1905)HT