



OPERATION MANUAL

DAIKIN ROOM AIR CONDITIONER



MODELS

- FTKM25XVMG
- FTKM35XVMG
- FTKM50XVMG
- FTKM60XVMG
- FTKM71XVMG



Features

Enhanced comfort and energy savings



INTELLIGENT EYE

The INTELLIGENT EYE sensor detects human movement in a room. If no one is in the room for more than 20 minutes, the operation automatically changes to energy saving operation.

▶ Page 17



WEEKLY TIMER

Up to 4 timer settings can be saved for each day of the week according to your family's life style. The WEEKLY TIMER allows you to set on/off times and the desired temperature. ▶ Page 25



POWERFUL

POWERFUL operation quickly maximises the cooling effect in any operation mode. ▶ Page 20

Other functions



COMFORT AIRFLOW

The airflow direction is upward while in COOL and DRY operation. This function prevents cold air from blowing directly on your body. ▶ Page 19



OUTDOOR UNIT QUIET

OUTDOOR UNIT QUIET operation assures a low noise level of the outdoor unit. This function is useful to maintain a quiet neighbourhood. ▶ Page 21



ECONO



This function enables efficient operation by limiting the maximum power consumption. It is useful when using the air conditioner and other electrical devices simultaneously on a shared electrical circuit. ▶ Page 21

Contents





Read Before Operation

Safety Precautions.....	3
Names of Parts	5
Preparation Before Operation	12



Basic Operation

 COOL · DRY · FAN Operation.....	14
 Adjusting the Airflow Rate.....	15
 Adjusting the Airflow Direction	16

Useful Functions

 INTELLIGENT EYE Operation.....	17
 COMFORT AIRFLOW Operation.....	19
 POWERFUL Operation.....	20
 ECONO / OUTDOOR UNIT QUIET Operation	21

TIMER Operation

 ON/OFF TIMER Operation	22
 WEEKLY TIMER Operation.....	25

Mobile Controller

 Wireless LAN Connection.....	31
--	----

Care

Care and Cleaning.....	32
------------------------	----



When the Need Arises



FAQ.....	36
Troubleshooting	37

Safety Precautions

	Read the precautions in this manual carefully before operating the unit.		This appliance is filled with R32.
---	---	---	---

- Keep this manual where the user can easily find it.
- The precautions described herein are classified as **WARNING** and **CAUTION**. They both contain important information regarding safety. Be sure to observe all precautions without fail.

 WARNING	Failure to follow these instructions properly may result in personal injury or loss of life.
 CAUTION	Failure to observe these instructions properly may result in property damage or personal injury, which may be serious depending on the circumstances.

 Never attempt.	 Be sure to follow the instructions.	 Be sure to establish an earth connection.
--	---	---

- After reading, keep this manual in a convenient place so that you can refer to it whenever necessary. If the equipment is transferred to a new user, be sure also to hand over the manual.

WARNING

- Do not use means to accelerate the defrosting process or to clean, other than those recommended by the manufacturer.
- The appliance must be stored in a room without continuously operating ignition sources (for example: open flames, an operating gas appliance or an operating electric heater).
- Do not pierce or burn.
- Be aware that refrigerants may not contain an odour.
- The appliance must be installed, operated and stored in a room with floor area larger than $-^*m^2$.
* Since the maximum refrigerant charge of the models is below 1.84kg, it does not have any limitation for the minimum floor area. Maintain an installation height of 2.5m or more from the floor surface to the bottom of the appliance.
- To avoid fire, explosion or injury, do not operate the unit when harmful gases (e.g. flammable or corrosive) are detected near the unit.
- Be aware that prolonged, direct exposure to cool or warm air from the air conditioner, or to air that is too cool or too warm, can be harmful to your physical condition and health.
- Do not place objects, including rods, your fingers, etc., in the air inlet or outlet. Product damage or personal injury may result due to contact with the air conditioner's high-speed fan blades.
- Do not attempt to repair, dismantle, reinstall or modify the air conditioner yourself as this may result in water leakage, electric shock or fire hazards.
- Do not use flammable spray near the air conditioner, or otherwise fire may result.
- Do not use a refrigerant other than the one indicated on the outdoor unit (R32) when installing, moving or repairing. Using other refrigerants may cause trouble or damage to the unit, and personal injury.
- To avoid electric shock, do not operate with wet hands.

- Beware of fire in case of refrigerant leakage. If the air conditioner is not operating correctly, i.e. not generating cool or warm air, refrigerant leakage could be the cause. Consult your dealer for assistance. The refrigerant within the air conditioner is safe and normally does not leak.
However, in the event of a leakage, contact with a naked burner, heater or cooker may result in generation of noxious gas. Do not use the air conditioner until a qualified service person confirms that the leakage has been repaired.
- Do not attempt to install or repair the air conditioner yourself. Improper workmanship may result in water leakage, electric shock or fire hazards. Please contact your local dealer or qualified personnel for installation and maintenance work.
- If the air conditioner is malfunctioning (giving off a burning odour, etc.), turn off power to the unit and contact your local dealer. Continued operation under such circumstances may result in a failure, electric shock or fire hazards.
- Be sure to install an earth leakage circuit breaker. Failure to install an earth leakage circuit breaker may result in electric shock or fire.

- Be sure to earth the unit. Do not earth the unit to a utility pipe, lightning conductor or telephone earth lead. Imperfect earthing may result in electric shock.

CAUTION

- Do not use the air conditioner for purposes other than those for which it is intended. Do not use the air conditioner for cooling precision instruments, food, plants, animals or works of art as this may adversely affect the performance, quality and/or longevity of the object concerned.
- Do not expose plants or animals directly to the airflow from the unit as this may cause adverse effects.
- Do not place appliances that produce naked flames in places exposed to the airflow from the unit as this may impair combustion of the burner.
- Do not block the air inlets nor outlets. Impaired airflow may result in insufficient performance or trouble.

-  Do not sit on the outdoor unit, put things on the unit, or pull the unit. Doing so may cause accidents, such as falling or toppling down, thus resulting in injury, product malfunctioning, or product damage.
- Do not place objects that are susceptible to moisture directly beneath the indoor or outdoor units. Under certain conditions, condensation on the main unit or refrigerant pipes, air filter dirt or drain blockage may cause dripping, resulting in fouling or failure of the object concerned.
- After prolonged use, check the unit stand and its mounts for damage. If they are left in a damaged condition, the unit may fall and cause injury.
- To avoid injury, do not touch the air inlet or aluminium fins of the indoor or outdoor units.
- The appliance is not intended for use by unattended young children or infirm persons. Impairment of bodily functions and harm to health may result.
- Children should be supervised to ensure that they do not play with the unit or its remote controller. Accidental operation by a child may result in impairment of bodily functions and harm health.
- Avoid impacts to the indoor and outdoor units, or otherwise product damage may result.
- Do not place flammable items, such as spray cans, within 1m of the air outlet.
The spray cans may explode as a result of hot air from the indoor or outdoor units.
- Be careful not to let pets urinate on the air conditioner. Urination on the air conditioner may result in electric shock or fire.
- Do not wash the air conditioner with water, as this may result in electric shock or fire.
- Do not place water containers (vases, etc.) above the unit, as this may result in electric shock or fire hazards if they should topple over.
- Do not insert the batteries in the wrong polarity (+/-) orientation as this may result in short circuiting, fire, or battery leakage.
- Do not sit or hang on the panel. The panel may fall, and injury or product malfunctioning may result.
- Do not sway the panel. The panel may hit people or objects, and injury or property damage may result.
- Do not let children play around the panel. Injury or property damage may result.
- Do not pull the wires. The wires may be broken and the panel may fall, and injury or property damage may result.
- Do not locate obstacles in the route. The panel may fall, and injury or property damage may result.
- Do not bend or damage the wires. The wires may be broken and the panel may fall, and injury or property damage may result.
- Do not put objects on the panel, or otherwise production malfunctioning may result.
- Do not use an unstable stand at the time of operating or maintaining the air conditioner, or otherwise you may topple over or injure yourself.
- Locate the remote controller in places out of reach of children. The wrong operation of the remote controller may result in injury.

-  To avoid oxygen depletion, ensure that the room is adequately ventilated if equipment such as a burner is used together with the air conditioner.
- Before cleaning, be sure to stop unit operation and turn off the circuit breaker. Otherwise, an electric shock and injury may result.
- Only connect the air conditioner to the specified power supply circuit. Power supplies other than the one specified may result in electric shock, overheating and fires.
- Arrange the drain hose to ensure smooth drainage. Imperfect drainage may cause wetting of the building, furniture, etc.
- Do not place objects in direct proximity of the outdoor unit and do not let leaves and other debris accumulate around the unit. Leaves are a hotbed for small animals which can enter the unit. Once inside the unit, such animals can cause malfunctions, smoke or fire if they come into contact with electrical parts.
- Do not place objects around the indoor unit.
Doing so may have an adverse influence on the performance, product quality, and life of the air conditioner.
- This appliance is not intended to be used by persons with reduced physical, sensory or mental capabilities, or with lack of operation knowledge, unless they have been given supervision or instruction concerning the appliance use by person responsible for their safety. Keep out of children's reach to ensure that they do not play with the appliance.

This is an appliance that is not accessible to the general public.

Precautions relating to area surrounding the indoor and outdoor units

- Be sure to follow the instructions below.
 - The indoor unit is at least 1m away from any television or radio set (unit may cause interference with the picture or sound).
 - Refrain from using the units in areas prone to high levels of oily smoke, such as a kitchen. Water leakage may result.

Names of Parts

For 25/35 class

Indoor Unit

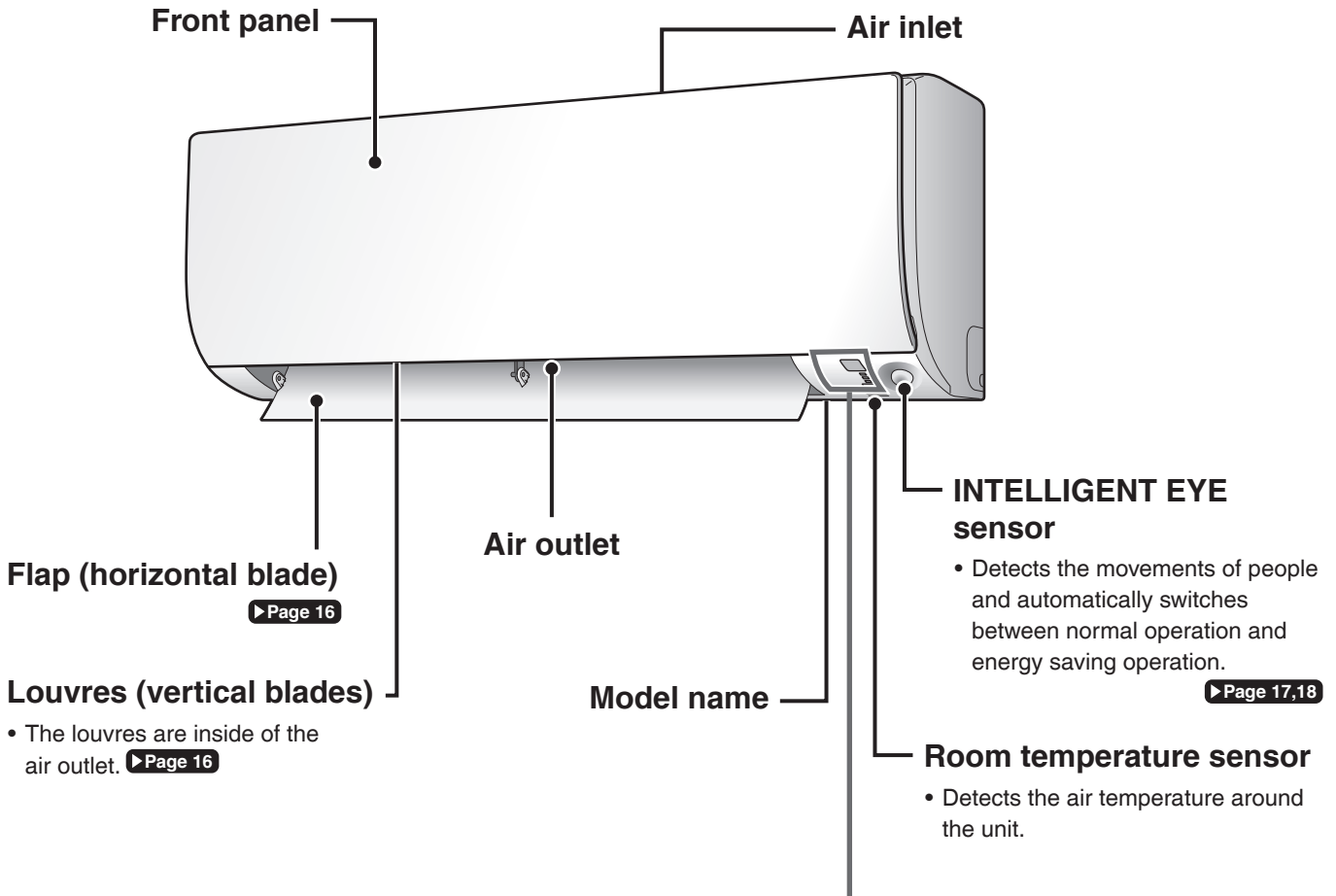

Display

Signal receiver

- Receives signals from the remote controller.
- When the unit receives a signal, you will hear a beep sound.

Case	Sound type
Operation start	beep-beep
Setting changed	beep
Operation stop	long beep

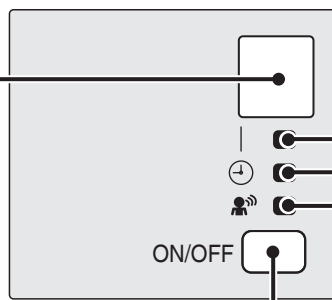

Indoor unit ON/OFF switch

- Press this switch once to start operation. Press once again to stop it.
- For the operation mode setting, refer to the following table.

Mode	Temperature setting	Airflow rate
COOL	22.0°C	AUTO

- This switch can be used when the remote controller is missing or out of batteries.

For 25/35 class

■ **Open the front panel**

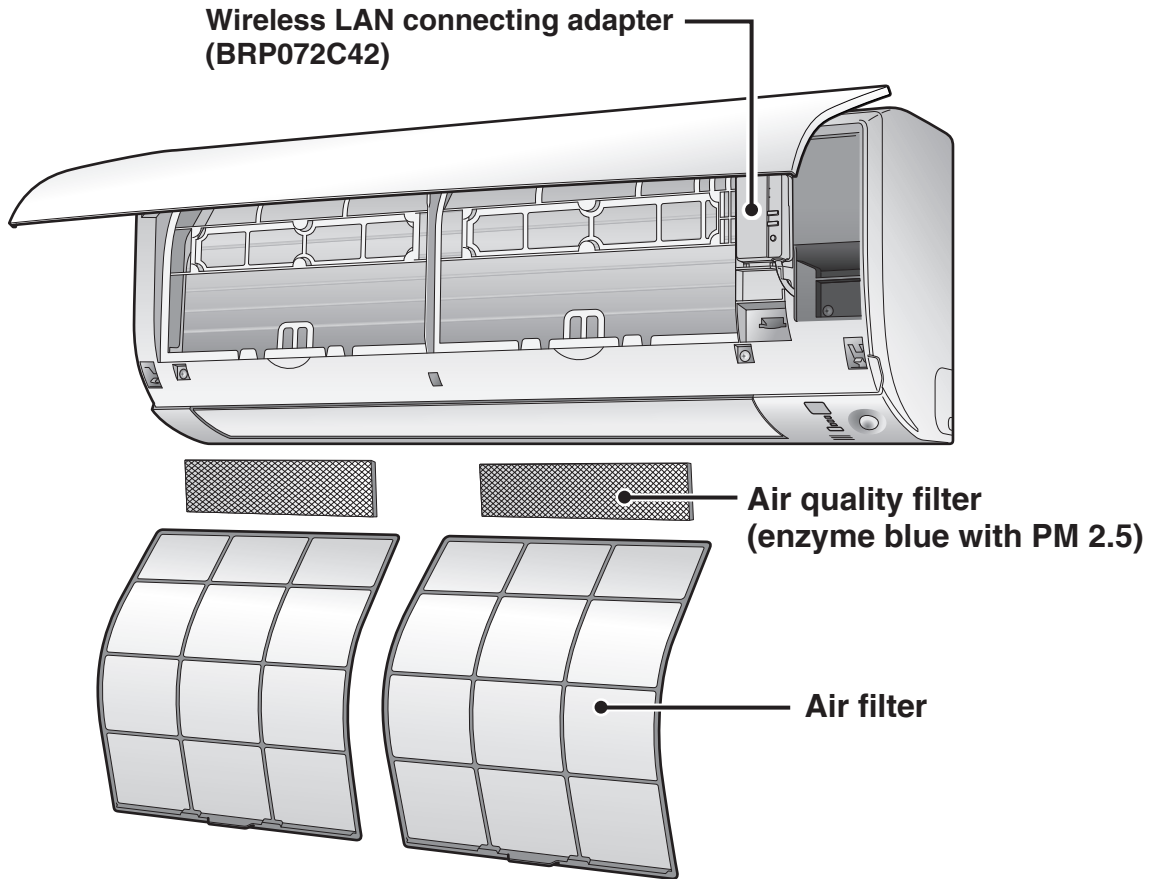

Outdoor Unit

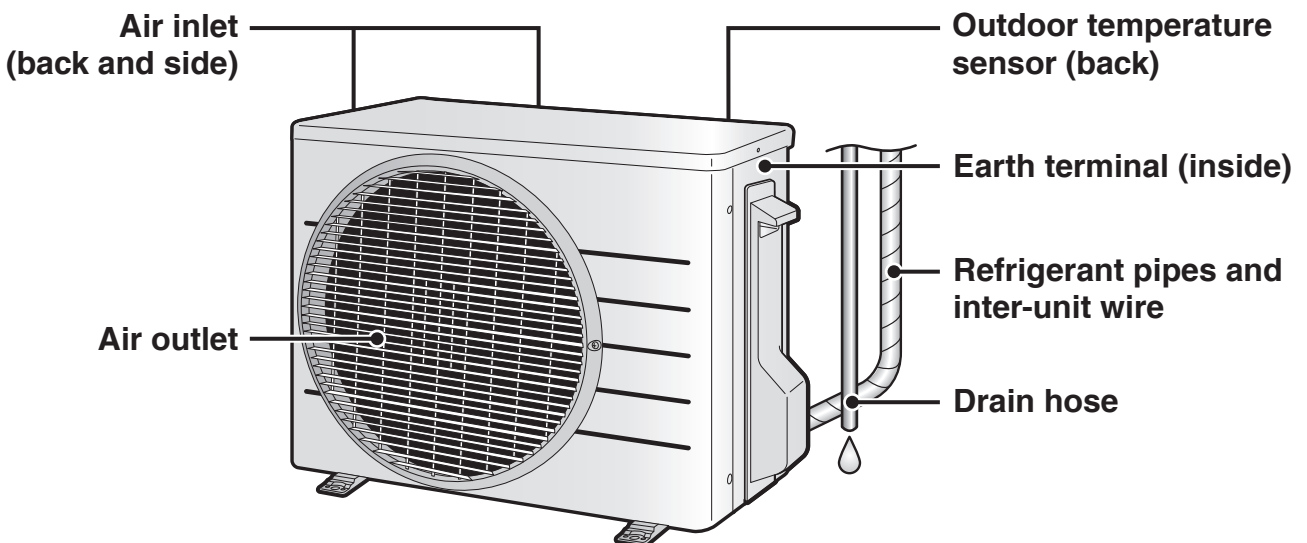

Names of Parts

For 50/60/71 class

Indoor Unit

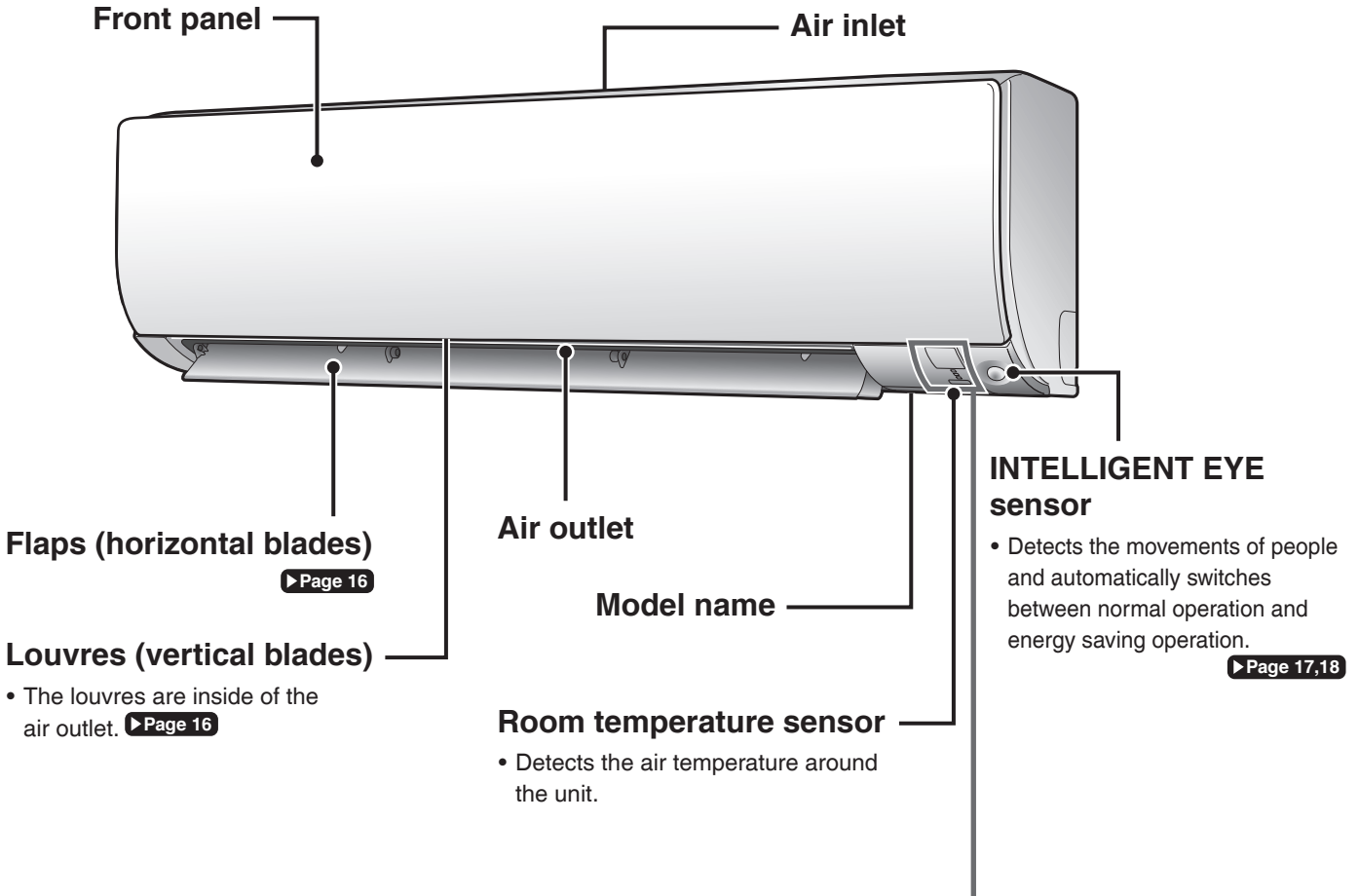

Display

Signal receiver

- Receives signals from the remote controller.
- When the unit receives a signal, you will hear a beep sound.

Case	Sound type
Operation start	beep-beep
Setting changed	beep
Operation stop	long beep

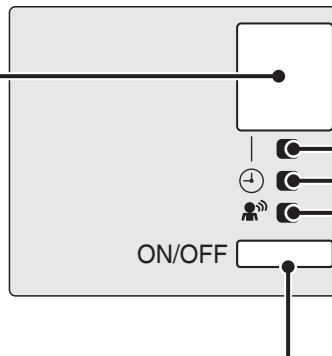

Indoor unit ON/OFF switch

- Press this switch once to start operation. Press once again to stop it.
- For the operation mode setting, refer to the following table.

Mode	Temperature setting	Airflow rate
COOL	22.0°C	AUTO

- This switch can be used when the remote controller is missing or out of batteries.

For 50/60/71 class

■ **Open the front panel**

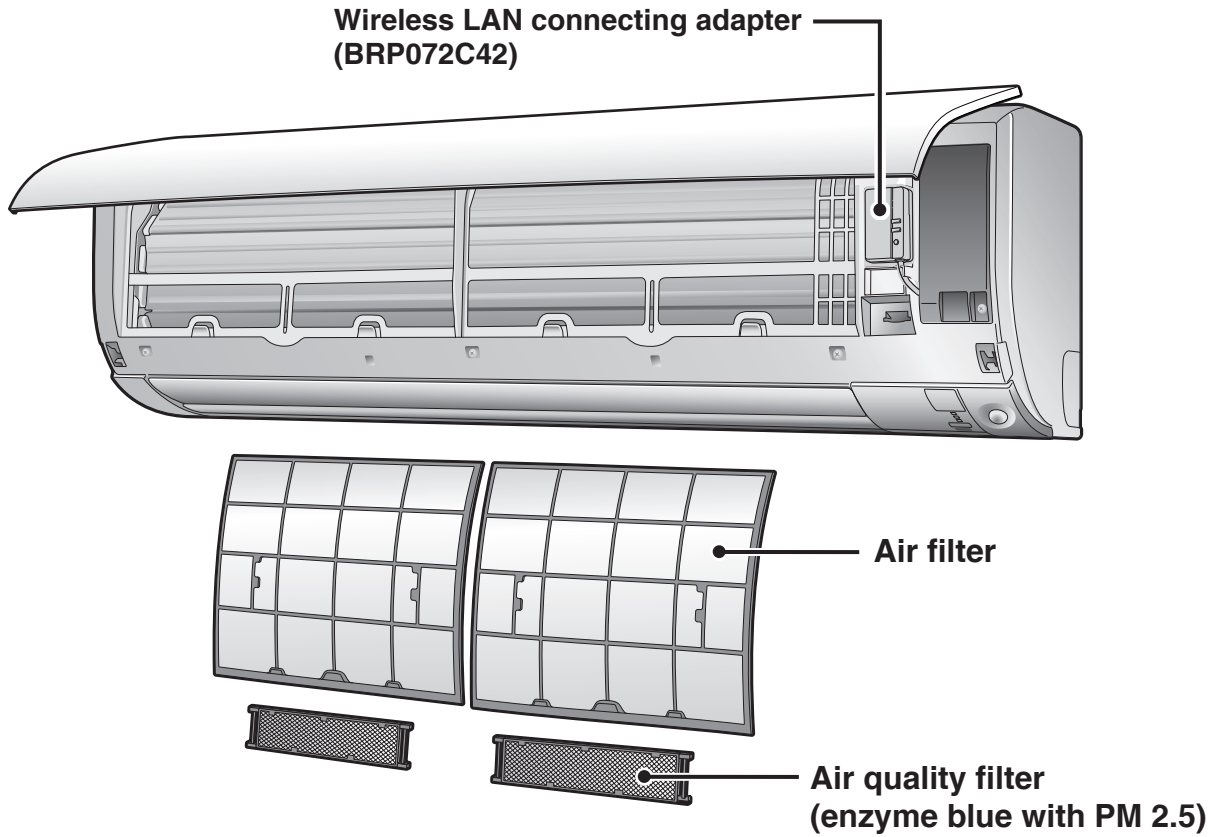

Outdoor Unit

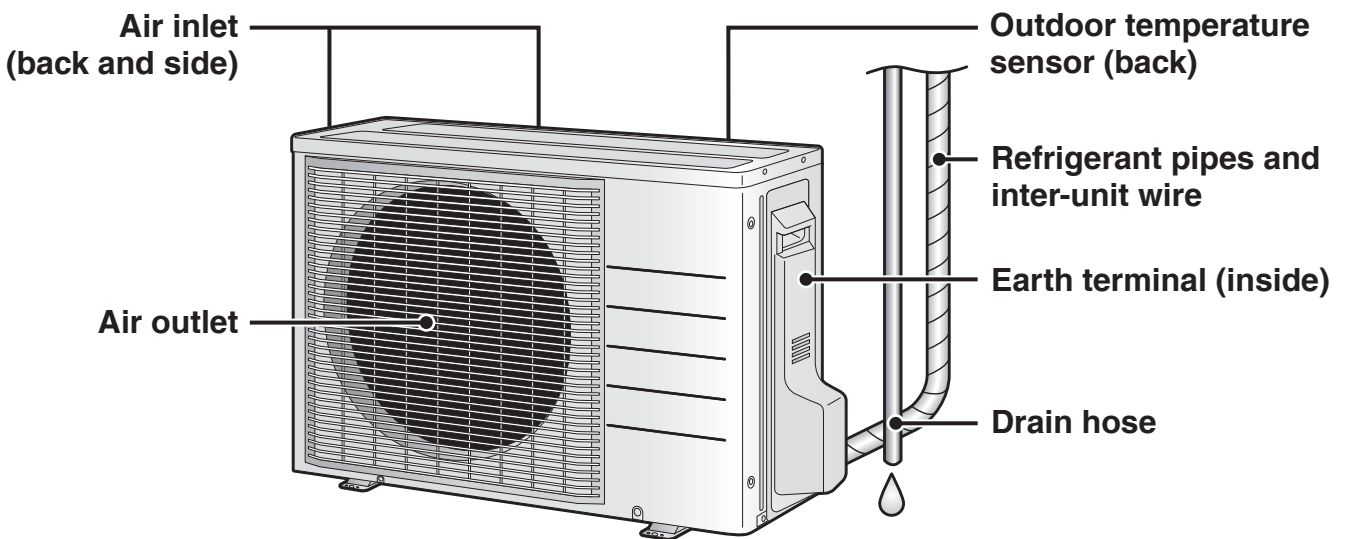

Names of Parts

Wireless LAN connecting adapter

ATTENTION

- When the Wireless LAN connecting adapter is operated, the RUN lamp may light through the front panel. If you find the lamp disturbing, the lamp can be disabled via the mobile application^[1].

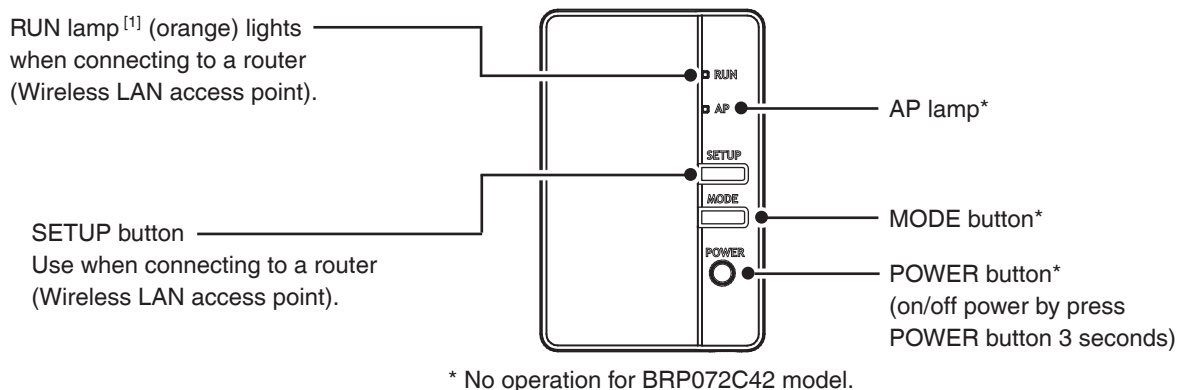

[1] The RUN lamp LED can be disabled via the mobile application

- Make sure the controller is connected to the Wireless LAN adapter and RUN lamp is lit.

To turn off the RUN lamp via the mobile application.

- Open "DAIKIN Mobile Controller" in your smartphone or tablet.
- Select "Setting" or icon "⚙️".
- Select "Adapter LEDs" and turn it off.
 - The RUN lamp turns off.
 - Mobile controller continues operating.

Specifications

Frequency range	2400 MHz–2483.5 MHz
Radio protocol	IEEE 802.11b/g/n
RF channel	1–13
Power supply	DC 14 V / 100 mA

RF channel: Radio frequency channel

Configuration

- The user is responsible for providing the following items before using this product:
 - Smartphone or tablet PC (Supported OS: Android 2.3.3 or later; iOS 5.0 or later.)
 - Internet line and communicating device (Modem/router or similar device)
 - Wireless LAN access point
 - Application name: [DAIKIN Mobile Controller] (free)

For details on the installation method for the DAIKIN Mobile Controller application, please see [▶ Page 31](#)

NOTE

Notes on the Wireless LAN connecting adapter

- Do not use this product near a microwave oven. (This can affect Wireless LAN communications.)
- For the latest details about installation of the Wireless LAN connecting adapter and applicable units, refer to the web site <https://www.daikintha.com/product/dmobile>.

Remote Controller

Signal transmitter



Receiver

- To use the remote controller, aim the transmitter at the indoor unit. If there is anything blocking the signals between the unit and the remote controller, such as a curtain, the unit may not operate.
- The maximum transmission distance is about 7m.

FAN setting button

- Selects the airflow rate setting.

▶ Page 15

POWERFUL button

- POWERFUL operation. ▶ Page 20

Display (LCD)

- Displays the current settings. (In this illustration, each section is shown with all its displays on for the purpose of explanation.)

TEMPERATURE adjustment button

- Changes the temperature setting.

▶ Page 14

ON/OFF button

- Press this button once to start operation.

Press once again to stop it. ▶ Page 14

Front cover

- Open the front cover. ▶ Page 11

Model name ARC466A29

Names of Parts

■ Open the front cover

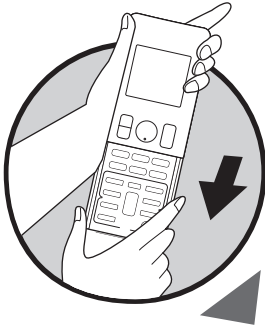

MODE selector button

- Selects the operation mode. (DRY/COOL/FAN)

▶ Page 14

ECONO/QUIET button

- ECONO/OUTDOOR UNIT QUIET operation. ▶ Page 21

SWING button

- Adjusts the airflow direction. ▶ Page 16

SENSOR button

- INTELLIGENT EYE operation. ▶ Page 17

COMFORT button

- COMFORT AIRFLOW operation. ▶ Page 19

OFF TIMER button (NIGHT SET mode)

▶ Page 23

TIMER CANCEL button

- Cancels the timer setting. ▶ Page 22,23
- Cannot be used for the WEEKLY TIMER operation.

SELECT button

- Changes the clock, ON/OFF TIMER and WEEKLY TIMER settings.

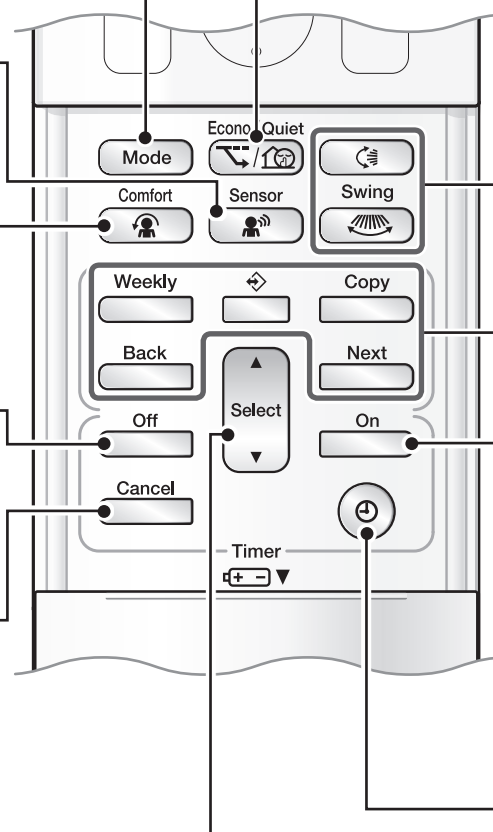

Weekly
[button] : WEEKLY button

[button] : PROGRAMME button

Copy
[button] : COPY button

Back
[button] : BACK button

Next
[button] : NEXT button

- WEEKLY TIMER operation. ▶ Page 25

ON TIMER button

▶ Page 22

CLOCK button

▶ Page 13

Preparation Before Operation

CAUTION

Incorrect handling of batteries can result in injury from battery leakage, rupturing or heating, or lead to equipment failure. Please observe the following precautions and use safely.

- If the alkaline solution from the batteries should get in the eyes, do not rub the eyes. Instead, immediately flush the eyes with tap water and seek the attention of a medical professional.
- Keep batteries out of reach of children. In the event that batteries are swallowed, seek the immediate attention of a medical professional.
- Do not expose batteries to heat or fire. Do not disassemble or modify batteries. The insulation or gas release vent inside the battery may be damaged, resulting in battery leakage, rupturing, or heating.
- Do not damage or peel off labels on the batteries.

■ To insert the batteries

1. Slide the front cover to take it off.
2. Insert 2 dry batteries AAA.LR03 (alkaline).
3. Replace the front cover.

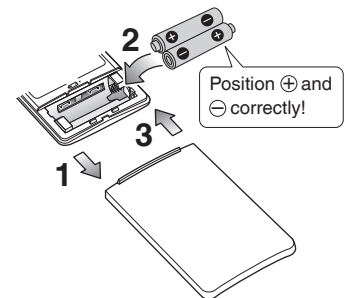

■ To fix the remote controller holder to a wall

1. Choose a place from where the signals reach the unit.
2. Fix the holder to a wall, a pillar, or similar location with the screws supplied with the holder.
3. Place the remote controller in the remote controller holder.

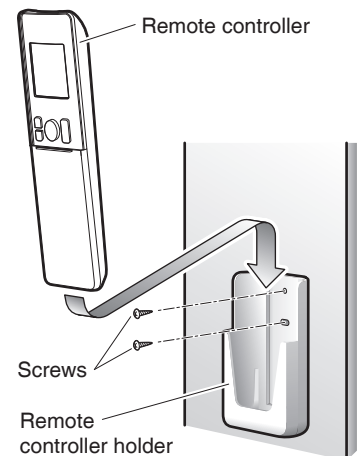

■ Turn on the circuit breaker

- After the power is turned on, the flap of the indoor unit opens and closes once to set the reference position.

■ To attach the air quality filter (enzyme blue with PM 2.5)

- If attaching the separately sold filters, attach them before turning the power on.
▶ Page 34

■ To check the function of the Wireless LAN connecting adapter

1. Open the front panel. ▶ Page 33
2. Turn on the main power supply and check that the RUN lamp of the Wireless LAN connecting adapter lights.
3. Close the front panel. ▶ Page 33

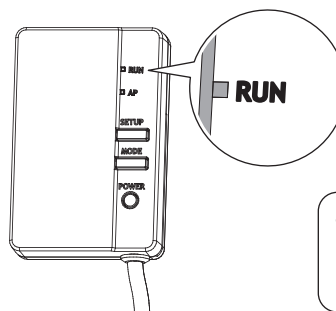

- When turning on the power, always attach the Wireless LAN connecting adapter case (upper).

NOTE

Notes on batteries

- To avoid possible injury or damage from battery leakage or rupturing, remove the batteries when not using the product for long periods of time.
- The standard replacement time is 1 year. Both batteries should be replaced at the same time. Be sure to replace them with new size AAA.LR03 (alkaline) batteries.
- When battery power has run out, the LCD will begin blinking as an alert that the batteries need replacing. In some cases, when battery consumption is accelerated owing usage conditions, signal reception may decline before the LCD begins blinking.
- The batteries supplied with the remote controller are for initial operation. The batteries may run out in less than 1 year.
- The usable period of the batteries may be short depending on the manufactured date of the air conditioner.

Notes on remote controller

- Do not drop the remote controller. Do not get it wet.
- Dust on the signal transmitter or receiver will reduce the sensitivity. Wipe off dust with soft cloth.
- Signal communication may be disabled if an electronic-starter-type fluorescent lamp (such as inverter-type lamps) is in the room. Consult the shop if that is the case.
- If the remote controller signals happen to operate another appliance, move that appliance to somewhere else, or consult the service shop.

Preparation Before Operation



■ To set the clock

1. Press .



“0:00” appears on the LCD.
“MON” and “⌚” blink.

2. Press  **to set the current day of the week.**

3. Press .



“⌚” blinks.

4. Press  **to set the clock to the present time.**

- Holding down ▲ or ▼ rapidly increases or decreases the displayed time.

5. Press .

- Point the indoor unit when pressing the buttons.



“.” blinks.

NOTE

Note on setting the clock

- If the indoor unit's internal clock is not set to the correct time, the ON/OFF TIMER and WEEKLY TIMER will not operate punctually.



COOL · DRY · FAN Operation



The air conditioner operates with the operation mode of your choice. From the next time on, the air conditioner will operate with the same operation mode.

■ To start

1. Press and select an operation mode.

- Each pressing of the button changes the mode setting in sequence.

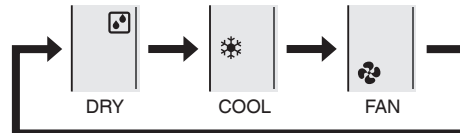

2. Press .

- “**ON**” appears on the LCD.
- The OPERATION lamp lights green.

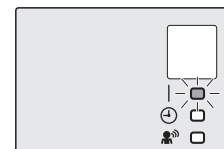

Display

■ To stop

▶ Press again.

- “**ON**” disappears from the LCD.
- The OPERATION lamp goes off.

■ To change the temperature setting

▶ Press .

- Press ▲ to raise the temperature and press ▼ to lower the temperature. Each pressing of the button changes the temperature by 0.5°C.

COOL operation	DRY or FAN operation
18.0-32.0°C	The temperature setting cannot be changed.

NOTE

Note on COOL operation

- This air conditioner cools the room by releasing the heat in the room outside. Therefore, the cooling performance of the air conditioner may be degraded if the outdoor temperature is high.

Note on DRY operation

- Eliminates humidity while maintaining the indoor temperature as much as possible. It automatically controls temperature and airflow rate, so manual adjustment of these functions is unavailable.

Note on FAN operation

- This mode is valid for fan only.



Adjusting the Airflow Rate

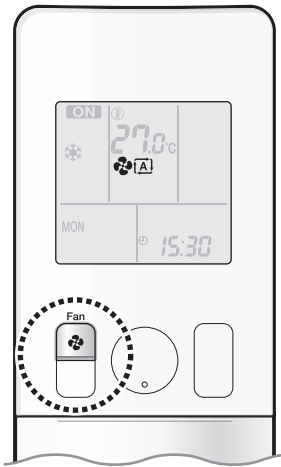



You can adjust the airflow rate to increase your comfort.

■ To adjust the airflow rate setting

▶ Press  .

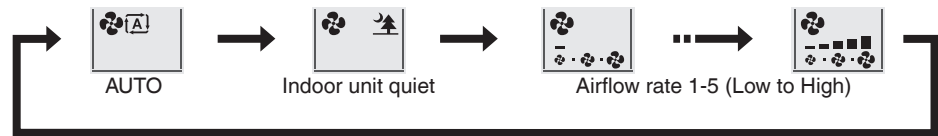
- Each pressing of the button changes the airflow rate setting in sequence.



- When the airflow is set to “”, quiet operation starts and noise from the indoor unit will become quieter.
- In the quiet operation mode, the airflow rate is set to a weak level.
- If COOL/DRY operation is started with airflow settings on “AUTO”, the indoor unit will initially deodorise, which functions to suppress any internal odours. As a result, the indoor unit will not emit air immediately. (Wait for about 1 minute.)
- At smaller airflow rates, the cooling effect is also smaller.

Tips for saving energy

Keeping the temperature setting at a moderate level helps save energy.

- Recommended temperature setting for cooling: 26.0-28.0°C

Cover windows with a blind or a curtain.

- Blocking sunlight and air from outdoors increases the cooling effect.

Keep the air filters clean.

- Clogged air filters cause inefficient operation and waste energy. Clean them once in about every 2 weeks. ▶ [Page 32](#)

If you are not going to use the air conditioner for a long period, for example in spring or autumn, turn off the circuit breaker.

- The air conditioner always consumes a small amount of electricity even while it is not operating.



Adjusting the Airflow Direction

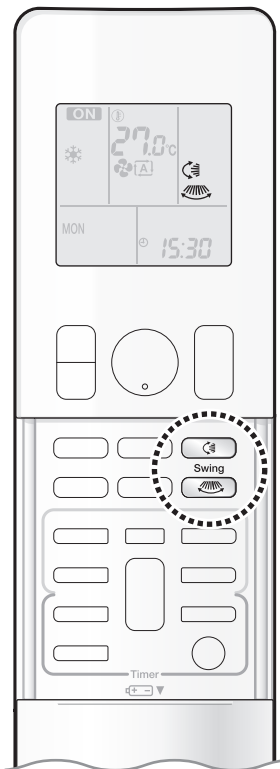

You can adjust the airflow direction to increase your comfort.

ATTENTION

- Always use a remote controller to adjust the angles of the flap and louvres.
 - If you attempt to move the flap and louvres forcibly by hand when they are swinging, the mechanism may be damaged.
 - Inside the air outlet, a fan is rotating at a high speed.

■ To start auto swing

Up and down airflow direction

Press  .

- “” appears on the LCD.
- The flap (horizontal blade) will begin to swing.

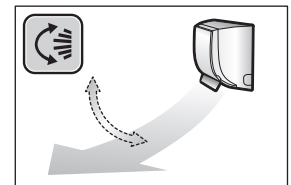

Right and left airflow direction



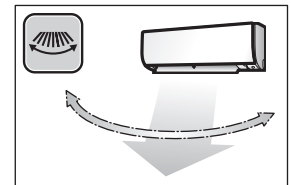

Press  .

- “” appears on the LCD.
- The louvres (vertical blades) will begin to swing.



The 3-D airflow direction

Press  and  .

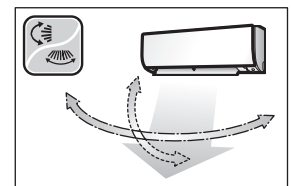

- “” and “” appear on the LCD.
- The flap and louvres move in turn.
- To cancel 3-D airflow, press either  or  again. The flap or louvres will stop moving.



■ To set the flap or louvres at the desired position

- This function is effective while the flap or louvres are in auto swing mode.

Press  and  when the flap or louvres reach the desired position.

- In the 3-D airflow, the flap and louvres move in turn.
- “” or “” disappears from the LCD.

NOTE

Notes on airflow direction setting

- The movable range of the flap varies according to the operation mode.
- The flap will stop at the upper position when the airflow rate is changed to low during the up and down swing setting.

Note on 3-D airflow

- Using 3-D airflow circulates cold air, which tends to collect at the bottom of the room, and hot air, which tends to collect near the ceiling, throughout the room, preventing areas of cold and hot developing.

Movable range of the flap

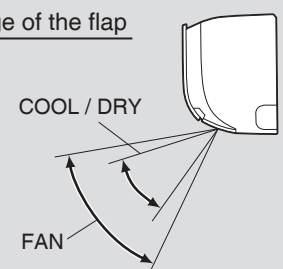



INTELLIGENT EYE Operation

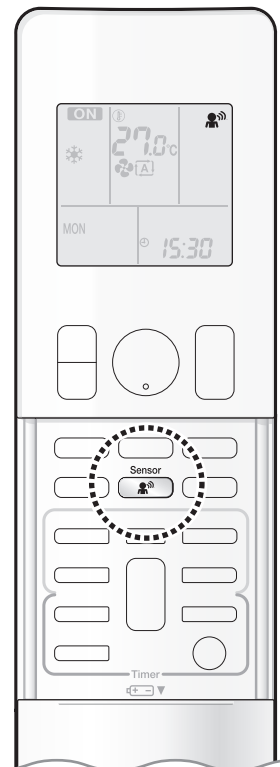

The INTELLIGENT EYE sensor detects human movement. If no one is in the room for more than 20 minutes, the operation automatically changes to energy saving operation.

⚠ CAUTION

- Do not place large objects near the INTELLIGENT EYE sensor. Also keep heating units and humidifiers outside the sensor's detection area. This sensor can detect undesirable objects.
- Do not hit or violently push the INTELLIGENT EYE sensor. This can lead to damage and malfunction.

■ To start

▶ Press **Sensor** .

- appears on the LCD.
- The INTELLIGENT EYE lamp lights green.

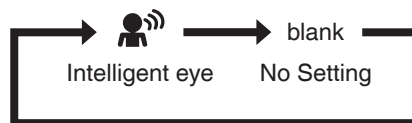
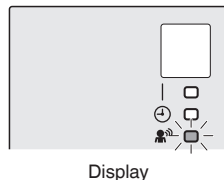

- The lamp lights when human movement is detected.

■ To cancel

▶ Press **Sensor** again.

- The INTELLIGENT EYE lamp goes off.

INTELLIGENT EYE operation is useful for energy saving

■ People are detected in the sensing area.

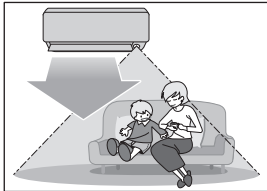

The air conditioner is in normal operation while the sensor is detecting human movement.

■ No people are detected in the sensing area.

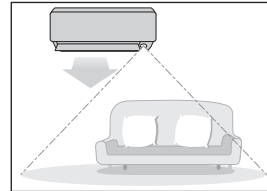

The air conditioner will switch to energy-saving mode after 20 minutes.

Energy saving operation

- If no presence detected in the room for 20 minutes, the energy saving operation will start, and the INTELLIGENT EYE lamp goes off. If human movement is detected again, the INTELLIGENT EYE lamp lights up and energy saving operation terminates.
- This operation changes the temperature by +2°C in COOL / +2°C in DRY operation from the set temperature. When the room temperature exceeds 30°C, the operation changes the temperature by +1°C in COOL / +1°C in DRY operation from the set temperature.
- This operation decreases the airflow rate slightly in FAN operation only.

NOTE

Notes on INTELLIGENT EYE operation

- Application range is as follows.

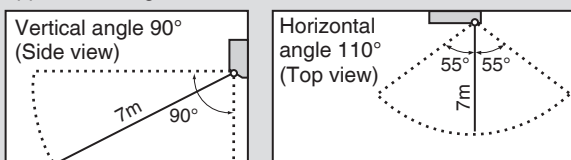

- The sensor may not detect moving objects further than 7m away. (Please see the application range)
- Sensor detection sensitivity changes according to the indoor unit location, the speed of passers-by, temperature range, etc.
- The sensor could also mistakenly detect pets, sunlight, fluttering curtains and light reflected off of mirrors as passers-by.
- NIGHT SET mode **▶Page 23** will not switch on during use of INTELLIGENT EYE operation.

Note on combination of COMFORT AIRFLOW operation and INTELLIGENT EYE operation

- The airflow rate will be set to AUTO. If the up and down airflow direction is selected, COMFORT AIRFLOW operation will be cancelled. Priority is given to the function of whichever button is pressed last.



COMFORT AIRFLOW Operation

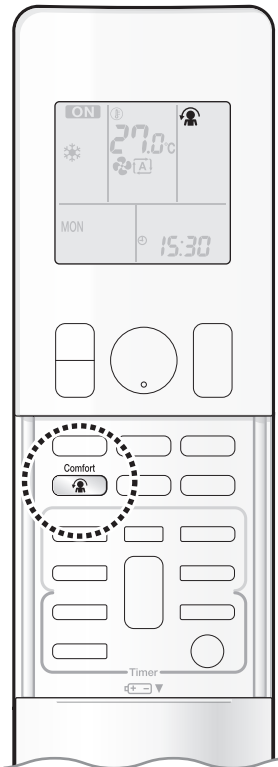

The airflow direction is upward while in COOL and DRY operation. This function prevents cold air from blowing directly on the occupants in the room.

■ To start

Press  .

- “” appears on the LCD.

	COOL and DRY operation
Flap direction	Goes up
Airflow rate	AUTO

- Not available in FAN operation.

■ To cancel

Press  again.

- “” disappears from the LCD.
- The flap will return to the memory position from before COMFORT AIRFLOW operation.

NOTE

Note on COMFORT AIRFLOW operation

- The airflow rate will be set to AUTO. If the up and down airflow direction is selected, COMFORT AIRFLOW operation will be cancelled.
- POWERFUL operation and COMFORT AIRFLOW operation cannot be used at the same time.



POWERFUL Operation

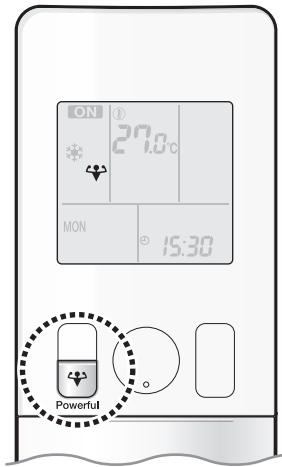

POWERFUL operation quickly maximises the cooling effect in any operation mode. In this mode, the air conditioner operates at maximum capacity.

■ To start

▶ Press  during operation.

- “” appears on the LCD.
- POWERFUL operation ends in 20 minutes. Then the system automatically operates again with the previous settings which were used before POWERFUL operation.

■ To cancel

▶ Press  again.

- “” disappears from the LCD.

NOTE

Notes on POWERFUL operation

- Pressing  causes the settings to be cancelled, and “” disappears from the LCD.
- POWERFUL operation will not increase the capacity of the air conditioner if the air conditioner is already in operation with its maximum capacity demonstrated.
 - **In COOL operation**
To maximise the cooling effect, the capacity of outdoor unit increases and the airflow rate becomes fixed at the maximum setting. The temperature and airflow settings cannot be changed.
 - **In DRY operation**
The temperature setting is lowered by 2.5°C and the airflow rate is slightly increased.
 - **In FAN operation**
The airflow rate is fixed at the maximum setting.

Regarding the combination of POWERFUL and other operations

POWERFUL + COMFORT AIRFLOW	
POWERFUL + ECONO	Not available*
POWERFUL + OUTDOOR UNIT QUIET	

*Priority is given to the function of whichever button is pressed last.



ECONO / OUTDOOR UNIT QUIET Operation

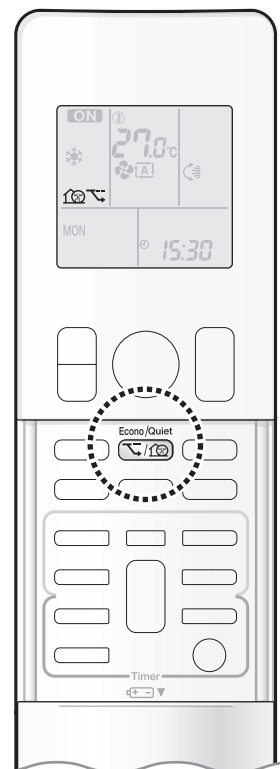

ECONO operation enables efficient operation by limiting the maximum power consumption.

This function is useful to prevent the circuit breaker from tripping when the unit operates alongside other appliances on the same circuit.

OUTDOOR UNIT QUIET operation lowers the noise level of the outdoor unit by changing the frequency and fan speed of the outdoor unit. This function is convenient during the night-time operation.

■ To start

▶ Press  and select the desired mode.

- Each time  is pressed, a different setting option appears on the LCD.





■ To cancel

▶ Press  until no icon is displayed.

NOTE

Notes on ECONO operation

- This operation is performed with lower power and therefore may not provide a sufficient cooling effect.
- Pressing  causes the settings to be cancelled, and “” disappears from the LCD.
- If the power consumption level is already low, switching to ECONO operation will not reduce the power consumption.

Notes on OUTDOOR UNIT QUIET operation

- Even if the operation is stopped by using the remote controller or the indoor unit ON/OFF switch when using OUTDOOR UNIT QUIET operation, “” will remain displayed on the remote controller.
- OUTDOOR UNIT QUIET operation will not reduce the frequency nor fan speed if they already are operating at reduced levels.
- This operation is performed with lower power and therefore may not provide a sufficient cooling effect.

Possible combinations of ECONO / OUTDOOR UNIT QUIET operation and basic operations

	Operation mode		
	DRY	COOL	FAN
ECONO	✓	✓	—
OUTDOOR UNIT QUIET	—	✓	—



ON/OFF TIMER Operation

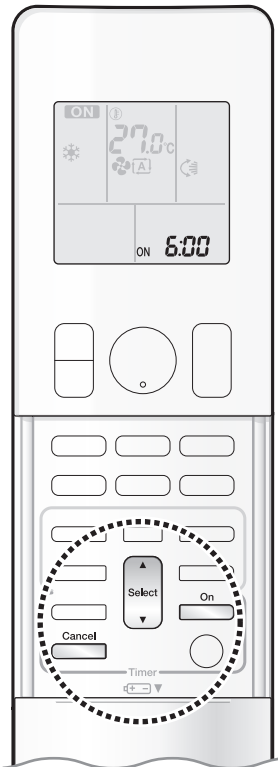

Timer functions are useful for automatically switching the air conditioner on or off at night or in the morning. You can also use the ON TIMER and OFF TIMER together.

[ON TIMER with a 24 hour clock display (24 HOUR ON/OFF TIMER)]

■ To set

- Check that the clock is correct.
If not, set the clock to the present time. ▶ [Page 13](#)
- To set the ON TIMER in an hours remaining display. ▶ [Page 24](#)

1. Press .



“6:00” appears on the LCD.
“ON” blinks.

- “⌚” and day of the week disappear from the LCD.

2. Press until the time setting reaches the point you like.

- Each pressing of either button increases or decreases the time setting by 10 minutes. Holding down either button changes the setting rapidly.

3. Press again.

- “ON” and setting time appear on the LCD.
- The TIMER lamp lights orange.

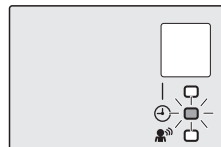

Display

■ To cancel

▶ Press .

- “ON” and setting time disappear from the LCD.
- “⌚” and day of the week appear on the LCD.
- The TIMER lamp goes off.

NOTE

Notes on TIMER operation

- When TIMER is set, the present time is not displayed.

In the following cases, set the timer again.

- After the circuit breaker has turned off.
- After a power failure.
- After replacing the batteries in the remote controller.



ON/OFF TIMER Operation

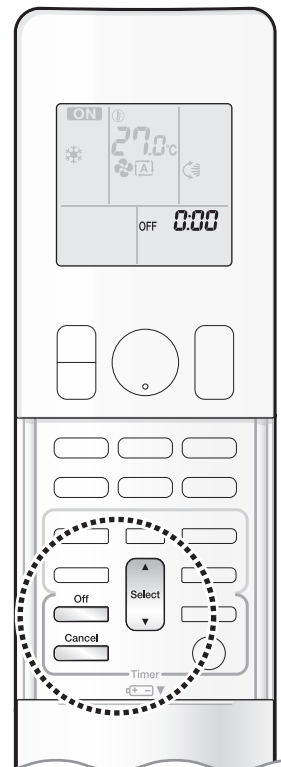

[OFF TIMER with a 24 hour clock display (24 HOUR ON/OFF TIMER)]

■ To set

- Check that the clock is correct.
If not, set the clock to the present time. ▶Page 13
- To set the OFF TIMER in an hours remaining display. ▶Page 24

1. Press .



“0:00” appears on the LCD.
“OFF” blinks.

- “☀” and day of the week disappear from the LCD.

2. Press until the time setting reaches the point you like.

- Each pressing of either button increases or decreases the time setting by 10 minutes. Holding down either button changes the time setting rapidly.

3. Press again.

- “OFF” and setting time appear on the LCD.
- The TIMER lamp lights orange.



Display

■ To cancel

▶ Press .

- “OFF” and setting time disappear from the LCD.
- “☀” and day of the week appear on the LCD.
- The TIMER lamp goes off.

[ON/OFF TIMER combination]

■ To combine

- A sample setting for combining the 2 timers is shown below.

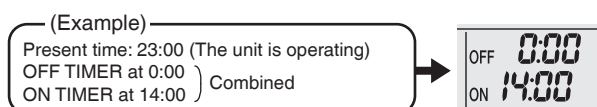

NOTE

NIGHT SET mode

- When the OFF TIMER is set, the air conditioner automatically adjusts the temperature setting (0.5°C up in COOL) to prevent excessive cooling during sleeping hours.

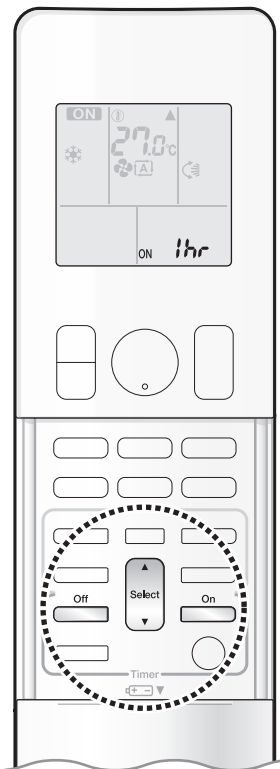

ON/OFF TIMER with an hours remaining display (COUNT UP-DOWN ON/OFF TIMER)

- Check that the clock is correct.
If not, set the clock to the present time. ▶ Page 13

1. Press and hold or for about 5 seconds, when signal indicator (▲) blinks, release your finger from the button.

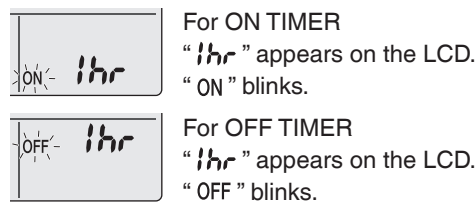

- “⌚” and day of the week disappear from the LCD.

2. Press until the time setting reaches the point you like.

- Each pressing of the button increases or decreases the time setting by 1 hour.
- The time can be set between 1 and 12 hours.

3. Press or again.

- “ON” or “OFF”, and setting time appear on the LCD.
- The TIMER lamp lights orange.

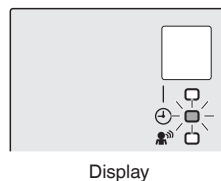

- To change the display mode from COUNT UP-DOWN ON/OFF TIMER to 24 HOUR ON/OFF TIMER, repeat **STEP 1**, and continue from **STEP 2** of “24 HOUR ON/OFF TIMER”. ▶ Page 22,23
- Timer display mode cannot be changed while “ON” or “OFF” are blinking.
Press or to stop the blinking.

■ Combining display modes

- Different display modes (24 HOUR ON/OFF TIMER and COUNT UP-DOWN ON/OFF TIMER) can be used for the ON TIMER and OFF TIMER simultaneously.



NOTE

Notes on COUNT UP-DOWN ON/OFF TIMER

- After setting, the time displayed on the LCD will automatically count down by 1 hour for every 1 hour that passes.
For example, if the OFF TIMER is set to 3 hours, the display will change as follows: 3hr → 2hr → 1hr → blank (OFF)

Switching between ON/OFF TIMER display modes (24 hour clock and hours remaining display)

- When changing timer display modes (from 24 HOUR ON/OFF TIMER to COUNT UP-DOWN ON/OFF TIMER or vice versa), the timer cancels.
The timer must be set again to activate it.



WEEKLY TIMER Operation

Up to 4 timer settings can be saved for each day of the week. This is convenient to adapt the WEEKLY TIMER to your family's life style.

■ Setting example of the WEEKLY TIMER

The same timer settings are used from Monday through Friday, while different timer settings are used for the weekend.

<p>[Monday]</p>	<p>Make timer settings for programmes 1-4. ▶Page 26</p> <p>Programme 1 Programme 2 Programme 3 Programme 4</p> <p>ON OFF ON OFF</p>
<p>[Tuesday to Friday]</p>	<p>Use the copy mode to make settings for Tuesday to Friday, because these settings are the same as those for Monday. ▶Page 28</p> <p>Programme 1 Programme 2 Programme 3 Programme 4</p> <p>ON OFF ON OFF</p>
<p>[Saturday]</p>	<p>No timer settings</p>
<p>[Sunday]</p>	<p>Make timer settings for programmes 1-4. ▶Page 26</p> <p>Programme 1 Programme 2 Programme 3 Programme 4</p> <p>ON OFF OFF ON</p>

- Up to 4 reservations per day and 28 reservations per week can be set using the WEEKLY TIMER. The effective use of the copy mode simplifies timer programming.
- The use of ON-ON-ON-ON settings, for example, makes it possible to schedule operating mode and set temperature changes. Furthermore, by using OFF-OFF-OFF-OFF settings, only the turn off time of each day can be set. This will turn off the air conditioner automatically if you forget to turn it off.

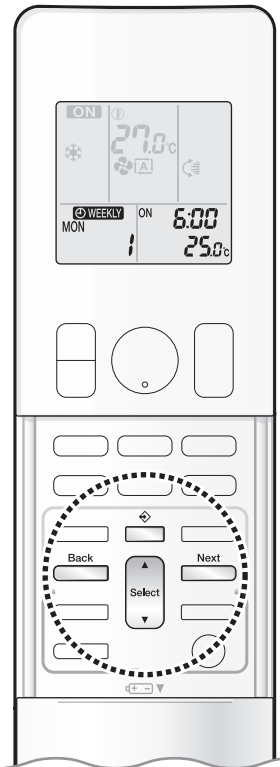

■ To use WEEKLY TIMER operation

Setting mode

- Make sure the day of the week and time are set.
If not, set the day of the week and time. ▶Page 13

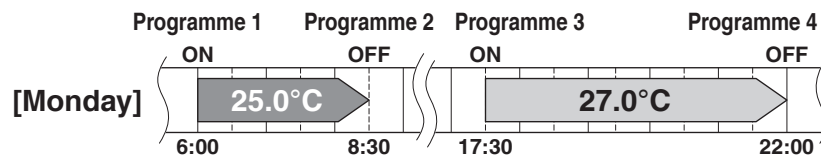

Setting Displays

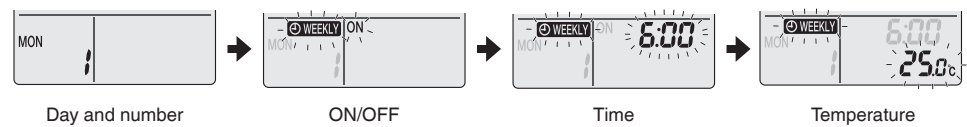

1. Press .

- The day of the week and the reservation number of the current day will be displayed.
- 1 to 4 settings can be made per day.

2. Press to select the desired day of the week and reservation number.

- Pressing changes the reservation number and the day of the week.

3. Press .

- The day of the week and reservation number will be set.
- “ WEEKLY” and “ON” blink.

4. Press to select the desired mode.

- Pressing changes the “ON” or “OFF” setting in sequence.



- In case the reservation has already been set, selecting “blank” deletes the reservation.
- Proceed to **STEP 9** if “blank” is selected.
- To return to the day of the week and reservation number setting, press .

5. Press .

- The ON/OFF TIMER mode will be set.
- “ WEEKLY” and the time blink.



WEEKLY TIMER Operation

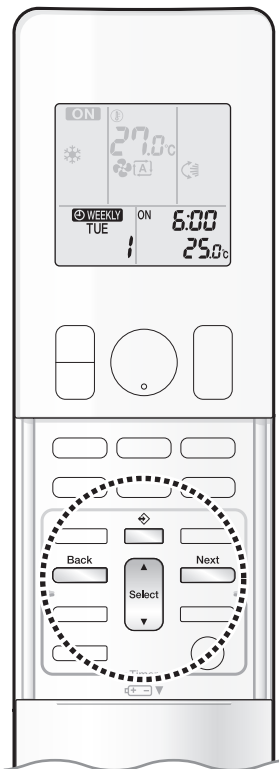



6. Press to select the desired time.

- The time can be set between 0:00 and 23:50 in 10-minute intervals.
- To return to the ON/OFF TIMER mode setting, press .
- Proceed to **STEP 9** when setting the OFF TIMER.

7. Press .

- The time will be set.
- “ WEEKLY” and the temperature blink.

8. Press to select the desired temperature.

- The temperature can be set between 10.0°C and 32.0°C.
COOL: The unit operates at 18.0°C even if it is set to 10.0°C to 17.0°C. 
- To return to the time setting, press .
- The set temperature is only displayed when the mode setting is on.

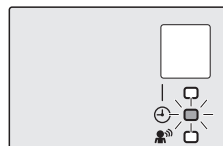

9. Press .

- Check for a receiving tone and that the OPERATION lamp blinks twice.
- The TIMER lamp lights orange.
- Temperature and time are set in the case of ON TIMER operation, and the time is set in the case of OFF TIMER operation.
- The next reservation screen will appear.
- To continue further settings, repeat the procedure from **STEP 4**.







Display

10. Press to complete the setting.

- “ WEEKLY” is displayed on the LCD and WEEKLY TIMER operation is activated.
- A reservation made once can be easily copied and the same settings used for another day of the week. Refer to **Copy mode**. 

NOTE

Notes on WEEKLY TIMER operation

- Do not forget to set the clock on the remote controller first. 
- The day of the week, ON/OFF TIMER mode, time and set temperature (only for ON TIMER mode) can be set with the WEEKLY TIMER. When set to ON TIMER mode, operation will begin in the settings used previously for operation mode, temperature, airflow rate, and airflow direction.
- WEEKLY TIMER and ON/OFF TIMER operation cannot be used at the same time. The ON/OFF TIMER operation has priority if it is set while WEEKLY TIMER is still active. The WEEKLY TIMER will enter the standby state, and “ WEEKLY” will disappear from the LCD. When the ON/OFF TIMER is up, the WEEKLY TIMER will automatically become active.
- Turning off the circuit breaker, power failure, and other similar events will render operation of the indoor unit's internal clock inaccurate. Reset the clock. 
-  can be used only for the time and temperature settings. It cannot be used to go back to the reservation number.

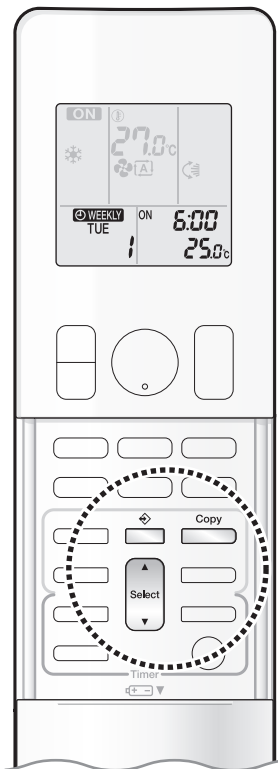

Copy mode

- A reservation made once can be copied to another day of the week. The whole reservation of the selected day of the week will be copied.

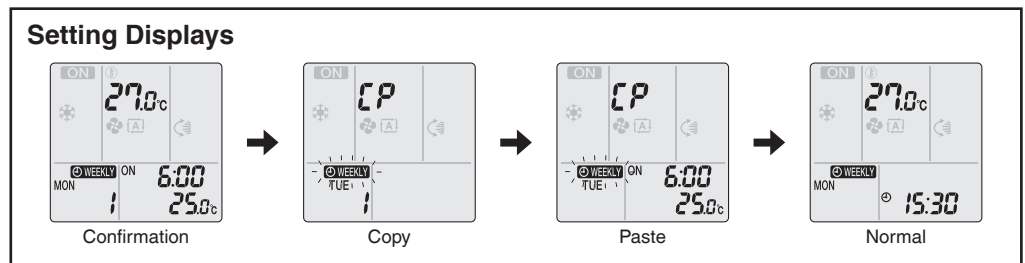
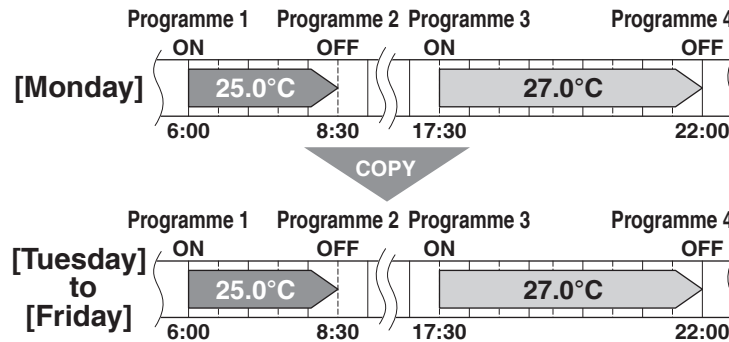

1. Press .

2. Press to confirm the day of the week to be copied.

3. Press .

- The whole reservation of the selected day of the week will be copied.

4. Press to select the destination day of the week.

5. Press .

- Check for a receiving tone and that the OPERATION lamp blinks twice.
- The reservation will be copied to the selected day of the week. The whole reservation of the selected day of the week will be copied.
- To continue copying the settings to other days of the week, repeat **STEP 4** and **STEP 5**.

6. Press to complete the setting.

- “ WEEKLY” appears on the LCD and WEEKLY TIMER operation is activated.

NOTE

Note on COPY MODE

- The entire reservation of the source day of the week is copied in the copy mode.

In the case of making a reservation change for any day of the week individually after copying the content of weekly reservations, press and change the settings in the steps of **Setting mode** . **Page 26**



WEEKLY TIMER Operation

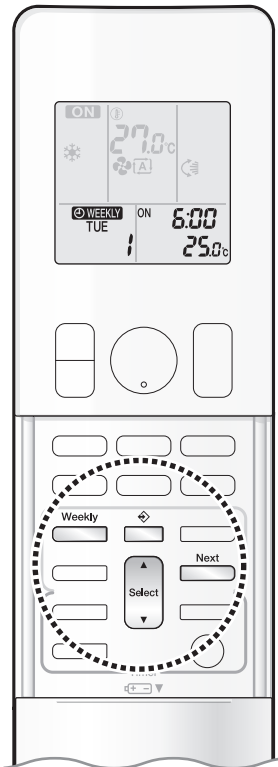

■ Confirming a reservation

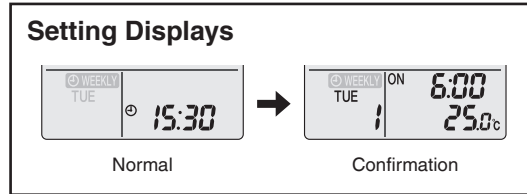

- The reservation can be confirmed.



1. Press .

- The day of the week and the reservation number of the current day will be displayed.

2. Press to select the day of the week and the reservation number to be confirmed.

- Pressing  displays the reservation details.
- To change the confirmed reserved settings, select the reservation number and press  . The mode is switched to setting mode. Proceed to **Setting mode** STEP 4. [▶Page 26](#)

3. Press to exit the confirmation mode.

- “ ” appears on the LCD and WEEKLY TIMER operation is activated.
- The TIMER lamp lights orange.

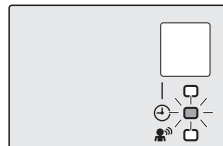

Display

■ To deactivate WEEKLY TIMER operation

▶ Press while “ ” is displayed on the LCD.

- “ ” disappears from the LCD.
- The TIMER lamp goes off.
- To reactivate the WEEKLY TIMER operation, press  again.
- If a reservation deactivated with  is activated once again, the last reservation mode will be used.

NOTE

- If not all the reservation settings are reflected, deactivate the WEEKLY TIMER operation once. Then press  again to reactivate the WEEKLY TIMER operation.

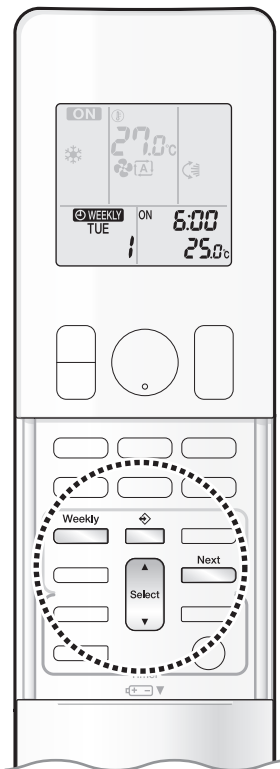

■ To delete a reservation

An individual reservation

1. Press .

- The day of the week and the reservation number will be displayed.

2. Press **to select the day of the week and the reservation number to be deleted.**

3. Press .

- “ WEEKLY” and “ON” or “OFF” blink.

4. Press **until no icon is displayed.**

- Pressing changes the ON/OFF TIMER mode in sequence.
- Selecting “blank” will cancel any reservation you may have.



5. Press .

- Check for a receiving tone and that the OPERATION lamp blinks twice.
- The selected reservation will be deleted.

6. Press .

- If there are still other reservations, WEEKLY TIMER operation will be activated.

Reservations for each day of the week

- This function can be used for deleting reservations for each day of the week.
- It can be used while confirming or setting reservations.

1. Press .

- The day of the week and the reservation number will be displayed.

2. Press **to select the day of the week to be deleted.**

3. Hold **for about 5 seconds.**

- Check for a receiving tone and that the OPERATION lamp blinks twice.
- The reservation of the selected day of the week will be deleted.

4. Press .

- If there are still other reservations, WEEKLY TIMER operation will be activated.

All reservations

Hold **for about 5 seconds with the normal display.**

- Check for a receiving tone and that the OPERATION lamp blinks twice.
- “ WEEKLY” disappears from the LCD.
- The TIMER lamp goes off.
- All reservations will be deleted.
- This operation is not functional while the WEEKLY TIMER setting screen is displayed.



Wireless LAN connection

Web site: <https://www.daikinthal.com/product/dmobile>

For information on the latest version of Wireless LAN control, please see the web site above.

■ Application software installation

- Before downloading the application software for installing, please read “Configuration” on [▶Page 9](#).

■ For Android Phones

- 1) Open the [Google Play].
- 2) Search using the application name: [DAIKIN Mobile Controller].
- 3) Follow the directions on the screen to install.

■ For iOS Phones

- 1) Open the [App Store].
- 2) Search using the application name: [DAIKIN Mobile Controller].
- 3) Follow the directions on the screen to install.

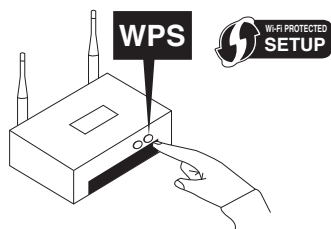
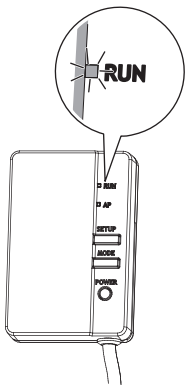

■ Simple Wireless LAN Connection Setting

- The setup is simple if there is a [WPS] button on the router (Wireless LAN access point).

1. Check that the [RUN] lamp is blinking.

2. Push the [WPS] button on the router (Wireless LAN access point).

- Operation of the [WPS] differs according to the router (Wireless LAN access point).
- Please refer to the documentation that comes with your router for more information. Does your router have a [WPS] button? For more information, see the manual of your router.

3. Push the [SETUP] button on the Wireless LAN connecting adapter for approximately 2 seconds.

- The [RUN] lamp on the Wireless LAN connecting adapter blinks more quickly. When the Wireless LAN connecting adapter and the router (Wireless LAN access point) are connected, this lamp lights. If you fail to connect, please try again from step 1 of “Simple Wireless LAN Connection Setting”. (It may not be possible to make the “Simple Wireless LAN Connection Setting”, depending on compatibility with the router.)

4. After connecting the Wireless LAN connecting adapter to the router, the user will be able to detect the Wireless LAN connecting adapter via the DAIKIN Mobile Controller application.

NOTE

Notes on the Wireless LAN connecting adapter

- In case simple wireless connection setting cannot be completed successfully, please refer to the web site above for other connection setting methods.

Care and Cleaning

⚠ CAUTION

- Before cleaning, be sure to stop the operation and turn off the circuit breaker.
- Do not touch the aluminum fins of the indoor unit. If you touch those parts, this may cause an injury.

■ Quick reference

* Appearance of the indoor unit may differ from some models.

Cleaning parts

Front panel

- Wipe it with a soft damp cloth.
- Only neutral detergent may be used.

If dirty



Air filter

- Vacuum dust or wash the filter.

Once every 2 weeks

▶ Page 33

Indoor unit and remote controller

- Wipe them with a soft cloth.

If dirty

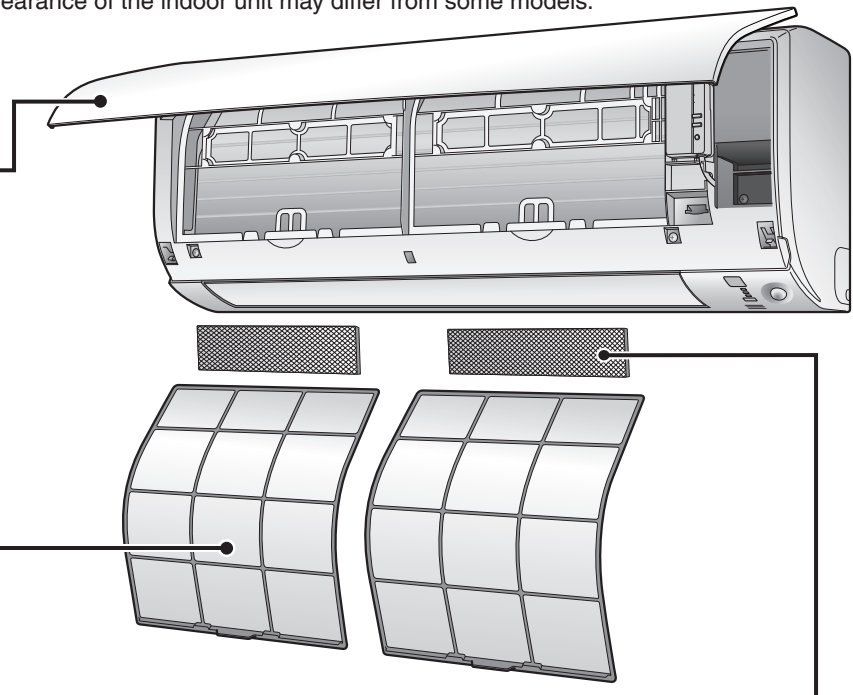

Air quality filter (enzyme blue with PM 2.5)

To purchase the filters (Table 1) or to purchase the another type, contact the dealer where you bought the air conditioner.

The method of cleaning and replacement of the filters may differ depending on the model. Refer to the label attached to the separately sold filters themselves.

Table 1

Item	Part No.
Air quality filter (enzyme blue with PM 2.5) - without frame (set of 2)	BAFP094A43
Deodorizing filter (enzyme blue) - without frame (set of 2)	BAFP094A41
Dust collection filter (PM 2.5) - without frame (set of 2)	BAFP046A41
Titanium apatite deodorizing filter - without frame (set of 2)	KAF970A46

Deodorizing filter (enzyme blue), Titanium apatite deodorizing filter.

- Vacuum dust or replace the filter.

[Cleaning]

Once every 6 months

▶ Page 34

[Replacement]

Once every 3 years

▶ Page 34

Air quality filter (enzyme blue with PM 2.5), Dust collection filter (PM 2.5)

- No cleaning is required. Please replace the filter every 6 months. ▶ Page 34

Notes on cleaning

For cleaning, do not use any of the following:

- Water hotter than 40°C
- Volatile liquid such as benzene, petrol and thinner
- Polishing compounds
- Rough materials such as a scrubbing brush

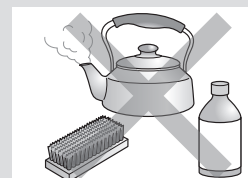

Care and Cleaning

* Appearance of the indoor unit may differ from some models.

■ Air filter

1. Open the front panel.

- Hold the front panel by the sides and open it.

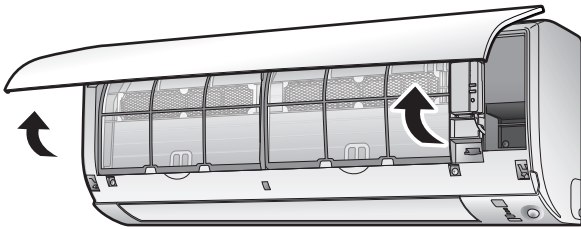

2. Pull out the air filters.

- Push the filter tab at the centre of each air filter a little upwards, then pull it down.

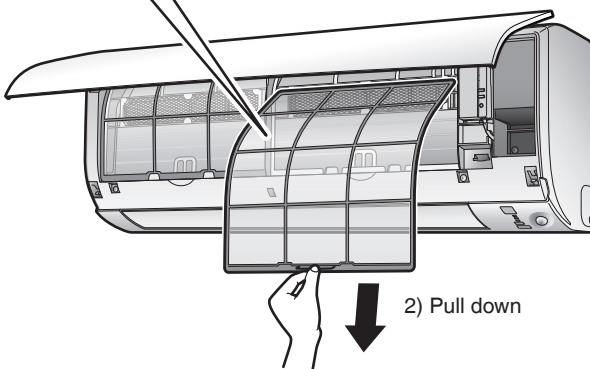
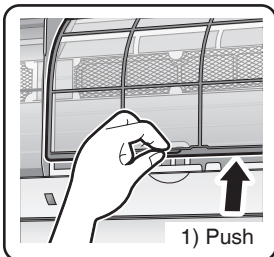

3. Wash the air filters with water or clean them with vacuum cleaner.

- It is recommended to clean the air filters every 2 weeks.

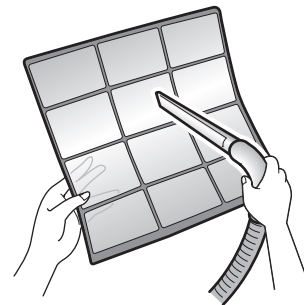

If the dust does not come off easily

- Wash the air filters with neutral detergent thinned with lukewarm water, then dry them up in the shade.
- Be sure to remove the filter (small) for 50/60/71 class. Refer to "Filter (small)" on the next page.



4. Reattach the filters.

5. Close the front panel slowly.

- Press the panel at both sides and the centre.

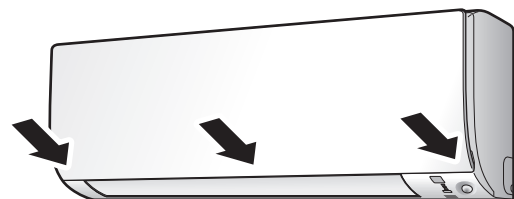

- Make sure that the front panel is securely fixed.

■ Filter (small)

* For the applicable filter type, please refer to **▶Page 32**.

Attaching

1. Open the front panel and pull out the air filters. **▶Page 33**
2. Insert the filter.

For 25/35 class

- Check that the filters are inserted securely under the tabs.

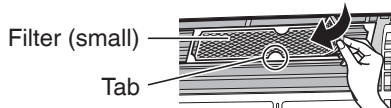

For 50/60/71 class

- Check that the filters are inserted securely under the tabs.

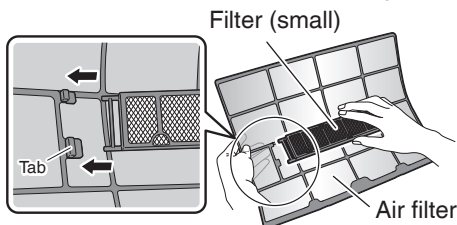

Cleaning and Replacement

1. Open the front panel and pull out the air filters. **▶Page 33**
2. Take off the filter.

For 25/35 class

- Remove the filters from the 6 tabs.

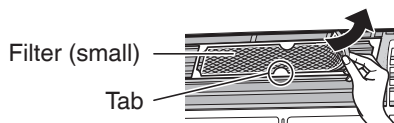

For 50/60/71 class

- Hold the recessed parts of the frame and unhook the 4 tabs.
- Remove the filters from the tabs.

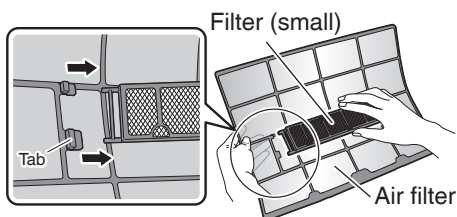

NOTE

- Operation with dirty filters:
 - cannot deodorise the air,
 - cannot clean the air,
 - results in poor cooling,
 - may cause odour.
- Dispose of old filters as non-flammable waste.

3. Clean or replace.

[Cleaning]

- ▶ Deodorizing filter (enzyme blue)
: Blue / titanium apatite
deodorizing filter : Blue-Black

3-1 Vacuum dust, and soak in lukewarm water or water for about 10 to 15 minutes if very dirty.

3-2 After washing, shake off remaining water and let them dry in the shade.

- This filter can be renewed by washing it with water once **every 6 months** and we recommend replacing it once **every 3 years**.
- Do not wring out the filter when removing water from it.

- ▶ Air quality filter (enzyme blue with PM 2.5) : Blue-White / Dust collection filter (PM 2.5) : White

- Do not wash the filters as this will reduce their efficiency.
- It is recommended to replace it once **every 6 months**.

[Replacement]

Remove the filter from the filter frame and prepare a new one.

- Do not throw away the filter frame. (for 50/60/71 class)
- Reuse the filter frame when replacing the filter. (for 50/60/71 class)

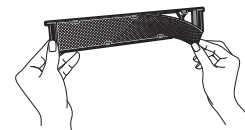

- When attaching the filter, check that the filter is properly set in the tabs. (for 25/35/50/60/71 class)



4. Set the filters as they were and close the front panel.

- Press the front panel at both sides and the center.

Care and Cleaning

■ Prior to a long period of non-use

1. Operate the FAN mode for several hours on a fine day to dry out the inside.

- 1) Press  and select “”.
- 2) Press  and start the operation.

2. After operation stops, turn off the circuit breaker for the room air conditioner.

3. Clean the air filters and reattach them. 

4. To prevent battery leakage, take out the batteries from the remote controller.

■ We recommend periodical maintenance

- In certain operating conditions, the inside of the air conditioner may get foul after several seasons of use, resulting in poor performance. It is recommended to have periodical maintenance by a specialist in addition to regular cleaning by the user.
- For specialist maintenance, please contact the dealer where you bought the air conditioner.
- The maintenance cost must be borne by the user.

FAQ

Indoor unit

The flap does not start swinging immediately.

- The air conditioner is adjusting the position of the flap. The flap will start moving soon.

Operation does not start soon.

- **When the unit is turned on again soon after being turned off.**
- **When the mode was reselected.**
 - This is to protect the air conditioner. You should wait for about 3 minutes.

Wireless LAN connecting adapter

The LEDs blink through the front panel.

- The lamp can be disabled via the mobile application.
 - ▶ **Page 9**

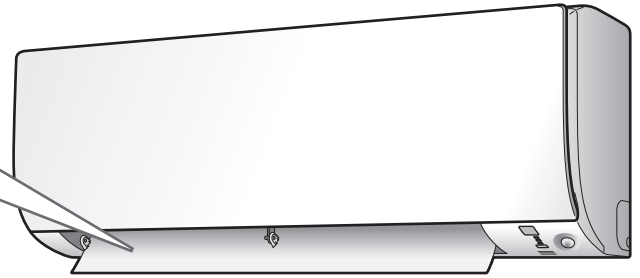
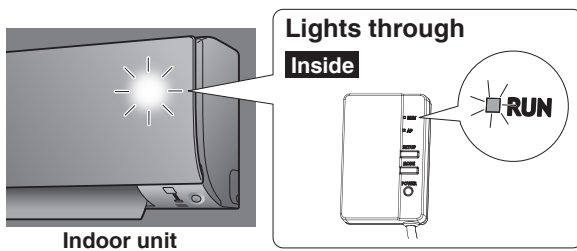

Different sounds are heard.

- **A sound like flowing water**
 - This sound is generated because the refrigerant in the air conditioner is flowing.
 - This is a pumping sound of the water in the air conditioner and can be heard when the water is pumped out from the air conditioner during COOL or DRY operation.
- **Ticking sound**
 - This sound is generated when the cabinet and frame of the air conditioner slightly expand or shrink as a result of temperature changes.
- **Clicking sound during operation or idle time**
 - This sound is generated when the refrigerant control valves or the electrical parts operate.
- **Clopping sound**
 - This sound is heard from the inside of the air conditioner when the exhaust fan is activated while the room doors are closed. Open the window or turn off the exhaust fan.
- **Rotating machinery causes sound**
 - Sound is heard when the vertical swing flap and the horizontal swing flap move.
 - When the air conditioner is operating in a quiet environment and the airflow rate of the indoor unit is set to Quiet Mode or Low Mode, the motion of the swing flap may cause sound.

Outdoor unit

The outdoor unit emits water.

- **In COOL or DRY operation**
 - Moisture in the air condenses into water on the cool surface of the outdoor unit piping and drips.

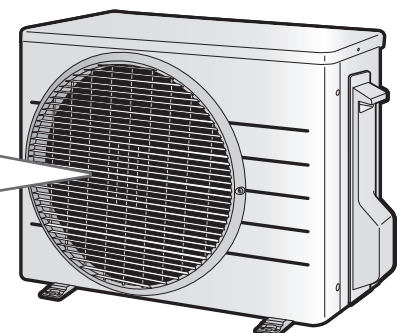

*The appearance of the outdoor unit may differ between different models.

Troubleshooting

Air conditioner

Before making an inquiry or a request for repair, please check the following.

If the problem persists, consult your dealer.



Not a problem

This case is not a problem.



Check

Please check again before requesting repairs.

The air conditioner does not operate

Case	Description / what to check
OPERATION lamp is off.	<ul style="list-style-type: none"> • Has the circuit breaker been tripped or the fuse blown? • Is there a power failure? • Are batteries set in the remote controller?
OPERATION lamp is blinking.	<ul style="list-style-type: none"> • Turn off the power with the circuit breaker and restart operation with the remote controller. If the OPERATION lamp is still blinking, check the error code and consult your dealer.

▶ Page 40

The air conditioner suddenly stops operating

Case	Description / what to check
OPERATION lamp is on.	<ul style="list-style-type: none"> • To protect the system, the air conditioner may stop operating after sudden large voltage fluctuations. It automatically resumes operation in about 3 minutes.
OPERATION lamp is blinking.	<ul style="list-style-type: none"> • Is there anything blocking the air inlet or air outlet of the indoor unit or outdoor unit? Stop operation and after turning off the circuit breaker, remove the obstruction. Then restart operation with the remote controller. If the OPERATION lamp is still blinking, check the error code and consult your dealer. ▶ Page 40

The air conditioner does not stop operating

Case	Description / what to check
The air conditioner continues operating even after operation is stopped.	<ul style="list-style-type: none"> <ul style="list-style-type: none"> ■ Immediately after the air conditioner is stopped <ul style="list-style-type: none"> • The outdoor unit fan continues rotating for about another 1 minute to protect the system. ■ While the air conditioner is not in operation <ul style="list-style-type: none"> • When the outdoor temperature is high, the outdoor unit fan may start rotating to protect the system.

The room does not cool down

Case	Description / what to check
Air does not come out.	<ul style="list-style-type: none"> <ul style="list-style-type: none"> ■ In COOL or DRY operation <ul style="list-style-type: none"> • If COOL/DRY operation is started with airflow settings on "AUTO", the indoor unit will initially deodorise, which functions to suppress any internal odours. As a result, the indoor unit will not emit air immediately. (Wait for about 1 minute.) ■ When the air conditioner operates immediately after the circuit breaker is turned on <ul style="list-style-type: none"> • The air conditioner is preparing to operate. Wait for about 3 to 20 minutes.
Air does not come out / Air comes out.	<ul style="list-style-type: none"> <ul style="list-style-type: none"> ■ Is the airflow rate setting appropriate? <ul style="list-style-type: none"> • Is the airflow rate setting low, such as "Indoor unit quiet" or "Airflow rate 1"? Increase the airflow rate setting. ■ Is the set temperature appropriate? ■ Is the adjustment of the airflow direction appropriate?
Air comes out.	<ul style="list-style-type: none"> <ul style="list-style-type: none"> • Is there any furniture directly under or beside the indoor unit? • Is the air conditioner in ECONO operation or OUTDOOR UNIT QUIET operation? ▶ Page 21 • Are the air filters dirty? • Is there anything blocking the air inlet or air outlet of the indoor unit or outdoor unit? • Is a window or door open? • Is an exhaust fan turning?

Air conditioner

Mist comes out

Case	Description / what to check
Mist comes out of the indoor unit.	? • This happens when the air in the room is cooled into mist by the cold airflow during COOL or other operation.

Remote controller

Case	Description / what to check
The unit does not receive signals from the remote controller or has a limited operating range.	? • The batteries may be exhausted. Replace both batteries with new dry batteries AAA.LR03 (alkaline). For details, refer to “Preparation Before Operation”. ▶Page 12 • Signal communication may be disabled if an electronic-starter-type fluorescent lamp (such as inverter-type lamps) is in the room. Consult your dealer if that is the case. • The remote controller may not function correctly if the transmitter is exposed to direct sunlight.
LCD is faint, is not working, or the display is erratic.	? • The batteries may be exhausted. Replace both batteries with new dry batteries AAA.LR03 (alkaline). For details, refer to “Preparation Before Operation”. ▶Page 12
The LCD is blinking and the remote controller cannot be operated.	? • Battery power has run out. Replace both batteries at the same time with new size AAA.LR03 (alkaline) batteries. Leaving exhausted batteries in the remote controller can result in injury due to battery leakage, rupturing or heating, or lead to equipment failure. (Even when the LCD is blinking, the OFF button remains functional.)
Other electric devices start operating.	? • If the remote controller activates other electric devices, move them away or consult your dealer.

Air has an odour

Case	Description / what to check
The air conditioner gives off an odour.	✓ • The room odour absorbed in the unit is discharged with the airflow. We recommend you to have the indoor unit cleaned. Please consult your dealer.

Others

Case	Description / what to check
The air conditioner suddenly starts behaving strangely during operation.	? • The air conditioner may malfunction due to lightning or radio. If the air conditioner malfunctions, turn off the power with the circuit breaker and restart the operation with the remote controller.
The ON/OFF TIMER does not operate according to the settings.	? • Check if the ON/OFF TIMER and the WEEKLY TIMER are set to the same time. Change or deactivate the settings in the WEEKLY TIMER. ▶Page 25

NOTE

Notes on the operating conditions



- If operation continues under any conditions other than those listed in the table,
 - A safety device may activate to stop the operation.
 - Dew may form on the indoor unit and drip from it when COOL or DRY operation is selected.

Mode	Operating conditions
COOL / DRY	Outdoor temperature: 19.4–46.0°C Indoor temperature: 18.0–32.0°C Indoor humidity: 80% max.

Troubleshooting

Wireless LAN connecting adapter

The following table provides brief descriptions of how to handle trouble or uncertainties when you install the Wireless LAN connecting adapter or make connection setting. Refer to the FAQ on our web site for more details.

When this happens	Explanation and where to check
None of the LEDs light.	 <ul style="list-style-type: none"> • Try to operate the unit with the infrared remote controller. • Turn off the air conditioner and restart it. • Make sure the LEDs are not disabled in the application. • Check the installation. • Check that the power of the Wireless LAN connecting adapter is ON by pressing the [POWER] button on the adapter.
The Wireless LAN connecting adapter is not visible on the unit overview screen (“HOME” screen) after the Wireless LAN connecting adapter has been configured.	 <ul style="list-style-type: none"> • Check that the power is on. • Check that the [RUN] lamp is lit. • If the [RUN] lamp is blinking, retry to connect the Wireless LAN connecting adapter to the Wireless network. Make sure the Wireless LAN connecting adapter is close enough to the router (Wireless LAN access point). • If the [RUN] lamp is lit, make sure that the smartphone or tablet is connected to the same Wireless LAN network as Wireless LAN connecting adapter.
None of the above work.	 <ul style="list-style-type: none"> • Refer to the FAQ on: https://www.daikinthal.com/product/dmobile

For instructions about how to operate the DAIKIN Mobile Controller application, please refer to the operation manual at <https://www.daikinthal.com/product/dmobile>

■ Call your dealer immediately

WARNING

When an abnormality (such as a burning smell) occurs, stop operation and turn off the circuit breaker.

- Continued operation in an abnormal condition may result in problems, electric shock or fire.
- Consult the dealer where you bought the air conditioner.

Do not attempt to repair or modify the air conditioner by yourself.

- Incorrect work may result in electric shock or fire.
- Consult the dealer where you bought the air conditioner.

If one of the following symptoms takes place, call your dealer immediately.

- The power cord is abnormally hot or damaged.
- An abnormal sound is heard during operation.
- The circuit breaker, a fuse, or the earth leakage circuit breaker cuts off the operation frequently.
- A switch or a button often fails to work properly.
- There is a burning smell.
- Water leaks from the indoor unit.

Turn off the circuit breaker and call your dealer.



■ After a power failure

- The air conditioner automatically resumes operation in about 3 minutes. Please wait for a while.

■ Lightning

- If there is a risk lightning could strike in the neighbourhood, stop operation and turn off the circuit breaker to protect the system.

■ Disposal requirements

- Dismantling of the unit, handling of the refrigerant, oil and other parts, should be done in accordance with the relevant local and national regulations.

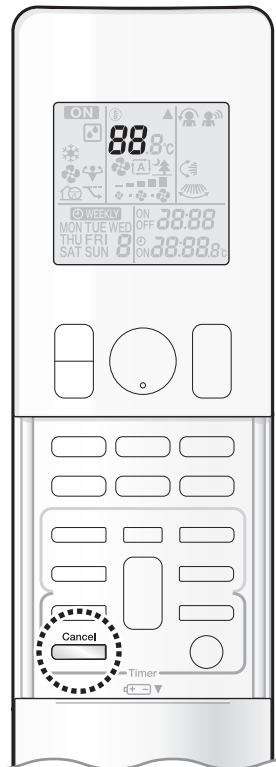

■ Fault diagnosis by remote controller

- In case the air conditioner is malfunctioning, you can check the error code via the remote controller before consulting with service personnel and informing them of the malfunction code.

1. When  is held down for about 5 seconds, “00” blinks in the temperature display section.

2. Press  repeatedly until a long beep is produced.

- The code indication changes as shown below, and notifies you with a long beep.

	CODE	MEANING
SYSTEM	00	NORMAL
	UA	INDOOR-OUTDOOR UNIT COMBINATION FAULT
	U0	REFRIGERANT SHORTAGE
	U2	DROP VOLTAGE OR MAIN CIRCUIT OVERVOLTAGE
	U4	FAILURE OF TRANSMISSION (BETWEEN INDOOR UNIT AND OUTDOOR UNIT)
INDOOR UNIT	A1	INDOOR PCB DEFECTIVENESS
	A5	HIGH PRESSURE CONTROL OR FREEZE-UP PROTECTOR
	A6	FAN MOTOR FAULT
	CC	FAULTY HUMIDITY SENSOR
	C4	FAULTY HEAT EXCHANGER TEMPERATURE SENSOR
OUTDOOR UNIT	C9	FAULTY SUCTION AIR TEMPERATURE SENSOR
	EA	COOLING-HEATING SWITCHING ERROR
	E1	CIRCUIT BOARD FAULT
	E5	OL STARTED
	E6	FAULTY COMPRESSOR START UP
	E7	DC FAN MOTOR FAULT
	E8	OVERCURRENT INPUT
	F3	HIGH TEMPERATURE DISCHARGE PIPE CONTROL
	F6	HIGH PRESSURE CONTROL (IN COOLING)
	F8	OPERATION HALT DUE TO COMPRESSOR INTERNAL TEMPERATURE ABNORMALITY
	H0	SENSOR FAULT
	H6	OPERATION HALT DUE TO FAULTY POSITION DETECTION SENSOR
	H8	DC CURRENT SENSOR FAULT
	H9	FAULTY SUCTION AIR TEMPERATURE SENSOR
	J3	FAULTY DISCHARGE PIPE TEMPERATURE SENSOR
J6	FAULTY HEAT EXCHANGER TEMPERATURE SENSOR	
L3	ELECTRICAL PARTS HEAT FAULT	
L4	HIGH TEMPERATURE AT INVERTER CIRCUIT HEATSINK	
L5	OUTPUT OVERCURRENT	
P4	FAULTY INVERTER CIRCUIT HEATSINK TEMPERATURE SENSOR	

NOTE

- A short beep and 2 consecutive beeps indicate non-corresponding codes.
- To cancel the code display, hold  down for about 5 seconds. The code display also clears if no button is pressed for 1 minute.

MEMO

Quick Reference

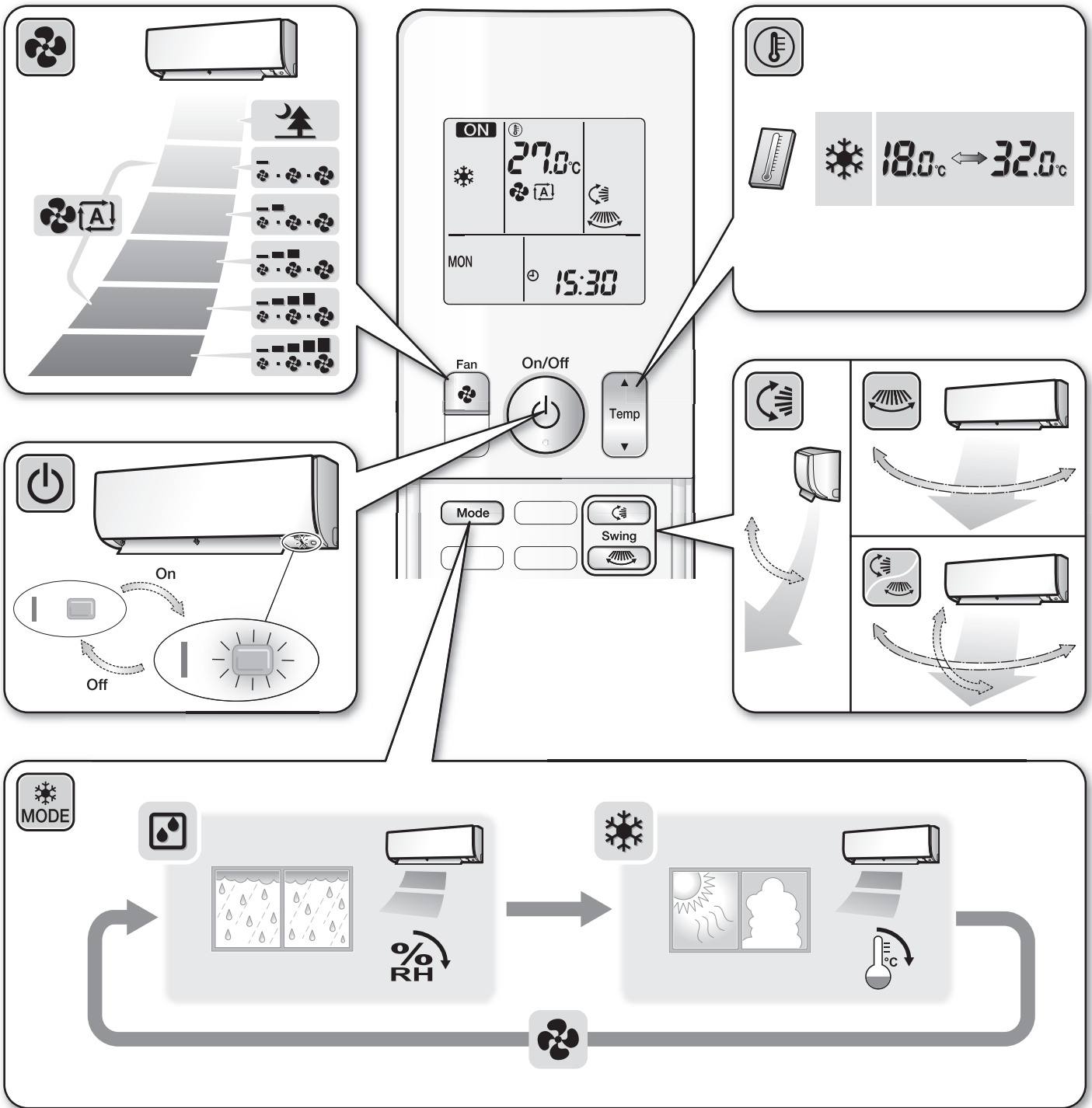

DAIKIN INDUSTRIES, LTD.

Head office:
 Umeda Center Bldg., 2-4-12, Nakazaki-Nishi,
 Kita-ku, Osaka, 530-8323 Japan

Tokyo office:
 JR Shinagawa East Bldg., 2-18-1, Konan,
 Minato-ku, Tokyo, 108-0075 Japan
<https://www.daikin.com>

Complies with
 IMDA Standards
 DA107930



The two-dimensional bar code is
 a manufacturing code.

3P620957-16R M22N119 (2212) HT