

# 13. Operation Manual

## 13.1 Indoor Unit

### ■ Example : FTX-J Series

#### Safety Precautions

- Read the following warnings and cautions carefully before operating the system and use it correctly.
- This manual classifies the precautions to the user into the following two categories. Be sure to follow all as they are all important to ensure safety.
- After reading this manual, keep it in a place easily accessible to the user for future reference.

**WARNING** Failure to follow a warning is very likely to result in such grave consequences as death or serious injury.

**CAUTION** Failure to follow a caution may result in serious injury or property damage, and in certain conditions, may result in a grave consequence.

**WARNING**

Do not attempt to extend the power cord by joining it to another cord, or by using an extension cord. Do not put any other loads on the power supply socket. Failure to follow this will cause electric shocks, abnormal heating or fire.	Do not damage or attempt to modify the power cord. Do not use the cord in a damaged state or tied in a bundle. Applying a heavy weight, heat or tension on the power cord will damage it, causing electric shocks or fire.	Do not expose your body to the cool (heat) air for a long time; do not cool (heat) the room too much. It will affect your physical conditions and cause health problems.
Do not put a finger, a rod or other objects into the air outlet or inlet. As the fan is rotating at a high speed, it will cause injury.	Do not attempt to repair, relocate, modify or reinstall the air conditioner by yourself. Incorrect work will cause electric shocks, fire etc. For repairs and reinstallation, consult the shop where you bought the air conditioner.	If anything abnormal such as a burning smell occurs, stop the operation immediately and turn the breaker OFF. Continued abnormal operation will cause troubles, electric shocks, fire etc. If anything is abnormal, consult the shop where you bought the air conditioner.

**CAUTION**

Do not use the air conditioner for preservation purposes. Do not use it for preserving precision instruments, foods, plants, animals, works of fine arts etc. Performance or quality may deteriorate and animal or plant life may be shorter.	Do not operate the air conditioner with a wet hand. It may cause an electric shock.	Ventilate the room from time to time. Be careful especially when using a burning appliance in the same room. Insufficient ventilation may cause shortage of oxygen.
Before cleaning, be sure to stop the operation and turn the breaker OFF. As a fan is rotating at a high speed, cleaning during operation may cause injury.	After a long use, check the unit stand and fittings for damage. The unit may drop and cause injury if damage is left unrepaired.	Do not stand or sit on the outdoor unit. Do not place any object on the unit. The object or the person may fall down or drop, causing injury.
Do not place under the indoor or outdoor unit anything which must be kept away from moisture. Indoor unit moisture in the air may condense and drip in certain conditions. Outdoor unit during cooling operation, condensation may drip from the piping connections.	Do not wash the unit with water. It may cause an electric shock.	Do not expose plants or animals directly to the air flow. It may cause adverse effects on the plant or the animal.
Do not place a vessel containing water on the unit. Water may penetrate into the unit and degrade electrical insulations, resulting in an electric shock.	Do not place a burning appliance in places exposed to the air flow from the unit or under the indoor unit. It may cause incomplete combustion or deformation of the unit from heat.	Do not block air inlets nor outlets. Impaired air flow may result in insufficient performance or troubles.

2

#### Names of Parts

**Indoor unit**

**ON/OFF button** (See page 8.)

**TIMER lamp (orange)** (See page 11 "Timer Operation".)

**Operation lamp (green)**

**Intelligent Eye lamp (green)** (See page 13 "Intelligent Eye".)

#### Opening the front grille

How to open the front grille : (See page 14 "Care and Cleaning".)

**CAUTION**

Before opening the front grille, be sure to stop the operation and turn the breaker OFF. If the power is on, the fan may rotate inside and may cause injury.

**Receiver:**

- It receives signals from the remote controller.
- When the unit receives a signal, you will hear a short beep.

**Intelligent Eye:**

- It detects the movements of people and automatically switches between normal operation and save operation. (See page 13.)

**Room temperature sensor:**

- It senses the air temperature around the unit.

**ON/OFF button**

- Push this button once to start operation. Push once again to stop it.
- This button is useful when the remote controller is missing.

**The operation mode refers to the following table.**

Mode	Temperature setting	Air flow rate
FTX COOL	22°C	AUTO
FTX AUTO	25°C	AUTO

In the case of multi system operation, there are times when the unit does not activate with this button. (See page 8.)

4

#### Installation

**WARNING**

**Do not attempt to install the air conditioner by yourself.**

Consult the service shop or a qualified technician. Incorrect work will result in water leakage, electric shocks or fire. For installation, consult the service shop where you bought the unit or a qualified technician.

**The air conditioner must be earthed.**

Incomplete earthing may result in electric shocks. Do not connect the earth line to a gas pipe, water pipe, lightning rod, or a telephone earth line.

**CAUTION**

**Do not connect the air conditioner to a power supply different from the specification.**

It may cause trouble or fire.

**Do not install the air conditioner in places where flammable gas may leak.**

If leaked gas should accumulate near the unit, fire may occur.

**Depending on the environment, an earth leakage breaker must be installed.**

Lack of an earth leakage breaker may result in electric shocks.

**Arrange the drain hose to ensure smooth drainage.**

Incomplete drainage may cause wetting of the building, furniture etc.

#### Installation site

- To install the air conditioner in the following types of environments, consult the shop.
    - Places with an oily ambient or where steam or soot occurs.
    - Salty environment such as coastal areas.
    - Places where sulfide gas occurs such as hot springs.
    - Places where snow may block the outdoor unit.
- The drain from the outdoor unit must be discharged to a place of good drainage.



- For efficient operation, take as large spaces around the unit as site allows.

#### Consider nuisance to your neighbours from noises.

- For installation, choose a place as described below.
  - A place solid enough to bear the weight of the unit which does not amplify the operation noise or vibration.
  - A place from where the air discharged from the outdoor unit or the operation noise will not annoy your neighbours.

#### Electrical work

- For power supply, be sure to use a separate power circuit dedicated to the air conditioner.

#### System relocation

- Relocating the air conditioner requires specialized knowledge and skills. Please consult the shop where you bought the air conditioner if relocation is necessary for moving or remodeling.

3

#### Remote controller

<FTK25, 35 FTX25, 35>

**Transmitter** It sends signals to the indoor unit.

**Display** It displays the current settings. (In this illustration, each section is shown with all its displays ON for the purpose of explanation. Some models may not show all its indications.)

**POWERFULL button** (See page 9 "POWERFUL Operation")

**MODE selector button** It selects the operation mode.

**Good Sleep Cooling Operation (G-SLEEP)** (See page 12 "Good Sleep Cooling Operation (G-SLEEP)")

**ON TIMER button** (See page 11 "Timer Operation")

**OFF TIMER button**

**ON TIMER Setting button** It changes the time setting

**TEMPERATURE/TIME adjustment buttons** It changes the temperature setting.

**ON/OFF button** Press it once to start operation. To stop it, press it once again.

**FAN setting button** It selects the air flow rate setting.

**SWING button** (See page 10 "Adjusting the Air Flow Direction")

**Intelligent Eye button** (See page 13 "Intelligent Eye Operation")

**TIMER CANCEL button** It cancels the timer setting.

**CLOCK button** (See page 7 "Preparation Before Operation - Setting the Clock")

<ARC423A1, ARC423A2>

5

## Preparation Before Operation

### Remote controller

#### Setting the batteries

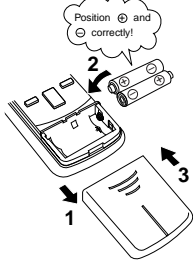

- Press with a finger and slide the back cover to take it off.
- Set two dry batteries (AAA).
- Set the back cover as before.
  - This will cause the figures on the display to flash. Set the clock at this point.

### ATTENTION

#### About batteries

- When replacing the batteries, use batteries of the same type, and replace the two old batteries together.
- When the system is not used for a long time, take the batteries out.
- When the operation display screen of the remote controller is hard to see and the reception becomes hard, replace the batteries with new AAA batteries.
- The attached batteries are provided for the initial use of the system. The usable period of the batteries may be short depending on the manufactured date of the air conditioner.

#### Operating the remote controller

- To use the remote controller, aim the transmitter at the indoor unit. If there is anything to block signals between the unit and the remote controller, such as a curtain, the unit will not operate.
- Do not drop the remote controller. Do not get it wet.
- The maximum distance for communication is about 7 m.

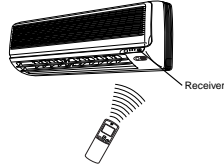

#### To fix the remote controller holder on the wall

- Choose a place from where the signals reach the unit.
- Fix the holder to a wall, a pillar, etc. with the screws supplied with the holder.
- Fit the claw of the holder into the bottom of the remote controller, and push the remote controller onto the wall.

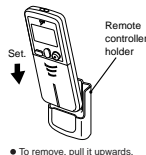

• To remove, pull it upwards.

### ATTENTION

#### About the remote controller

- Never expose the remote controller to direct sunlight.
- Dust on the signal transmitter or receiver will reduce the sensitivity. Wipe off dust with soft cloth.
- Signal communication may be disabled if an electronic-starter-type fluorescent lamp (such as inverter-type lamps) is in the room. Consult the shop if that is the case.
- If the remote control signals happen to operate another appliance, move that appliance to somewhere else, or consult the shop.

6

## Preparation Before Operation

### Indoor unit

#### Setting the air purifying filters

- Open the front grille
  - Hold the grille by the tabs on the two sides and lift it until it stops with a click. (about 60°)

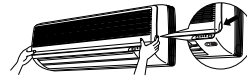

- Pull out the air filters.
  - Push upwards the tab at the center of each air filter, then pull it down.

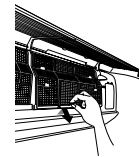

- Set the air purifying filters.
  - Attach an air purifying filter to each air filter. (See page 14 "Care and cleaning")

- Set the air filters in their original positions and close the front grille.
  - Operation without air filters may result in troubles as dust will accumulate inside the indoor unit.

#### Setting the clock

- Press .
  - AM 0:00 is displayed.
  - blinks.

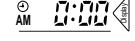

- Press to set the clock to the present time.
  - TIMER



- Holding down () or () button

rapidly increases or decreases the time display.

- Press .
  - blinks.

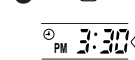

(Now the clock is set.)

#### Turn the breaker ON

- Turning ON the breaker opens the flap, then closes it again. (This is a normal procedure.)

### NOTE

#### Tips for saving energy

- Be careful not to cool (heat) the room too much. Keeping the temperature setting at a moderate level helps save energy.

Recommended temperature setting	
For cooling: 26°C – 28°C	
For heating: 20°C – 24°C	

- Cover windows with a blind or a curtain. Blocking sunlight and air from outdoors increases the cooling (heating) effect.
- Clogged air filters cause inefficient operation and waste energy. Clean them once in about every two weeks.

#### Please note

- The air conditioner always consumes 15 – 35 watts of electricity even while it is not operating.
- If you are not going to use the air conditioner for a long period, for example in spring or autumn, turn the breaker OFF.
- Use the air conditioner in the following conditions.

Mode	Operating conditions	If operation is continued out of this range:
COOL	Outdoor temperature : 10 to 40°C (In 32°C MAX. and MIN.: 10 to 43°C)	• A safety device may work to stop the operation.
	Indoor temperature : 18 to 32°C	• In multi system, it may work to stop the operation of the outdoor unit only.
	Indoor humidity : 30% max.	• Condensation may occur on the indoor unit and pipe.
HEAT	Outdoor temperature : -10 to 21°C	• A safety device may work to stop the operation.
	Indoor temperature : 18 to 32°C (In 32°C MAX. and MIN.: 21 to 43°C)	• A safety device may work to stop the operation.
DRY	Outdoor temperature : 18 to 32°C	• Condensation may occur on the indoor unit and pipe.
	Indoor humidity : 30% max.	• Condensation may occur on the indoor unit and pipe.

- Operation outside this humidity or temperature range may cause a safety device to disable the system.

7

## AUTO • DRY • COOL • HEAT • FAN Operation

The air conditioner operates with the settings of your choice. From the next time on, the air conditioner will operate with the same settings.

- Press **MODE** and select a mode.

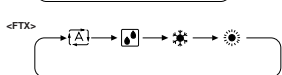
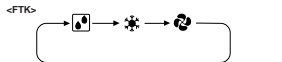
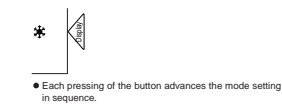

- Press **ON/OFF**. Then OPERATION lamp lights up.



#### To stop:

- Press **ON/OFF** once again.

Then OPERATION lamp goes off.

#### To change the temperature setting:

DRY or FAN mode	AUTO or HEAT or COOL mode
The temperature setting is not variable.	Press  to raise the temperature and press  to lower the temperature. Set to the temperature you like.

#### To change the air flow rate setting:

Press **FAN**.

DRY mode	AUTO or HEAT or COOL or FAN mode
The air flow rate setting is not variable.	Five levels of air flow rate setting from  to  are available.

- At smaller air flow rates, cooling or heating effect is also smaller.

#### To change the air flow direction:

(See page 10.)

### NOTE

#### -Note on HEAT mode operation-

Since this air conditioner heats the room by taking heat from outdoor air to indoors, the heating capacity becomes smaller in lower outdoor temperatures. If the heating effect is insufficient, it is recommended to use another heating appliance in combination with the air conditioner.

The heat pump system heats the room by circulating hot air around all parts of the room. After the start of heating operation, it takes some time before the room gets warmer. In heating operation, frost may occur on the outdoor unit and lower the heating capacity. In that case, the system switches into defrosting operation to take away the frost. During defrosting operation, hot air does not flow out of indoor unit.

#### -Note on DRY mode operation-

This operation dehumidifies the indoor air when it is humid.

#### -Note on AUTO operation-

In AUTO operation, the system selects a temperature setting and an appropriate mode (COOL or HEAT) based on the room temperature at the start of the operation. The system automatically reselects setting at a regular interval to bring the room temperature to user-setting level.

If you do not like AUTO operation, you can select manually, you like the mode and setting.

8

## POWERFUL Operation

POWERFUL operation quickly maximizes the cooling effect in any operation mode. You can get the maximum capacity with a touch of a button.

- Pressing the **POWERFUL** button during operation starts POWERFUL operation.
- POWERFUL operation ends in 20 minutes. Then the system automatically operates again with the settings which were used before POWERFUL operation.

- Press .



#### To cancel POWERFUL operation:

- Press .

#### Notes on POWERFUL operation

- In COOL and HEAT mode**
  - To maximize the cooling and heating effect, the capacity of outdoor unit must be increased and the air flow rate be fixed to the maximum setting.
  - The temperature and air flow settings are not variable.
- In DRY mode**
  - The temperature setting is lowered by 3°C and the air flow rate is slightly increased.
- In FAN mode**
  - The air flow rate is fixed to the maximum setting.

## Note for Multi System

- Precedence-room setting**
  - When setting the precedence-room during installation, the indoor unit's operation mode always takes priority.
  - When the precedence-setting room unit is operated in POWERFUL mode, there are times that air conditioners in other rooms will temporarily stop in order to centralize power to the unit in the room.
  - Please adjust the precedence-room setting to match your life style. Moreover, for precedence-room settings, please consult the service shop where you bought the unit.
  - Precedence-room setting is applied to only 4MX80, 4MK90.

- COOL/HEAT mode**
  - This mode is used to set the unit to only cool or heat. For information on using this mode, consult the service shop where you bought the unit.
  - COOL/HEAT mode is applied to only 4MX80, 4MK90.

### NOTE

#### -Note for heat pump multi system-

When two or more indoor units have no precedence-room settings and are set to modes that differ from each other, the indoor unit which is operated first activates, while the other indoor unit does not activate and the OPERATION lamp blinks. (This is not a malfunction.) An indoor unit that is not in operation will automatically start and operate in the mode in which a previously operated indoor unit was stopped. However, if the unit in operation provides only COOL and DRY modes, simultaneous operation is possible.

9

## Adjusting the Air Flow Direction

You can adjust the air flow direction to increase your comfort.

### Adjusting the horizontal blade (flap)

Press **CSWING**.

- Every time the button is pressed, "CSWING" appears or disappears.

..... The flap automatically swings up and down.

..... To stop the flap at an angle you like, press **CSWING**.

### Notes on flap angles

- When **CSWING** is selected, the flap swinging range depends on the operation mode. (See the figure.)
- The real flap angles are differ from the display of remote controller.

In DRY mode or COOL mode

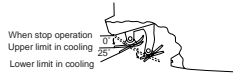

In HEAT or FAN mode

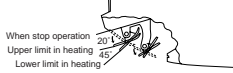

### ATTENTION

- Always use a remote controller to adjust the flap angle. If you attempt to move it forcibly with hand when it is swinging, the mechanism may be broken.

10

### Adjusting the louvre

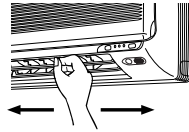

Hold the knob and move the louvre. (You will find a knob on the left-side and the right-side blades.)

### ATTENTION

- Be careful when adjusting the louvre. Inside the air outlet, a fan is rotating at a high speed.

## Timer Operation

Timer functions are useful for automatically switching the air conditioner on or off at night or in the morning. You can also use OFF TIMER and ON TIMER in combination.

### OFF TIMER operation

- Check that the clock is correct. If not, set the clock to the present time. (See page 7.)

1 Press **OFF** while the air conditioner is operating.

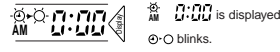

2 Press until the time setting reaches the point you like.

- Every pressing of either button increases or decreases the time setting by 10 minutes. Holding down either button changes the setting rapidly.

3 Press **OFF** once again.



### To cancel the timer:

Press **CANCEL**. Then the TIMER lamp goes off.

### Notes on OFF TIMER

- NIGHT SET MODE**  
When the OFF TIMER is set, the air conditioner automatically adjusts the temperature setting (0.5°C up in COOL; 2.0°C down in HEAT) to prevent excessive cooling (heating) for your pleasant sleep.

### ON TIMER operation

- Check that the clock is correct. If not, set the clock to the present time. (See page 7.)

1 Press **ON** while the air conditioner is not operating.

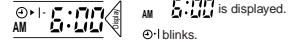

2 Press until the time setting reaches the point you like.

- Every pressing of either button increases or decreases the time setting by 10 minutes. Holding down either button changes the setting rapidly.

3 Press **ON** once again.



### To cancel the timer:

Press **CANCEL**. Then the TIMER lamp goes off.

### Combining ON TIMER and OFF TIMER

- A sample setting for combining the two timers is shown below.

(Example)  
Present time: 11:00 PM  
(The unit operating)  
OFF TIMER at 0:00 a.m.  
ON TIMER at 7:00 a.m. Combined

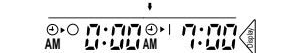

### Notes on ON, OFF TIMER

- When TIMER is set, the present time is not displayed.
- Once you set ON, OFF TIMER, the time setting is kept in the memory. (The memory is canceled when remote controller batteries are replaced.)

### ATTENTION

- In the following cases, set the timer again.
  - After a breaker has turned OFF.
  - After a power failure.
  - After replacing batteries in the remote controller.

11

## Good Sleep Cooling Operation (G-SLEEP)

\*The "Good Sleep Cooling Operation" makes the 1/f Fluctuating Temperature. It brings you comfortable sleep as it prevents from getting chilled.

1 Press **G-SLEEP** in cooling operation.

To change the temperature setting. (See page 8.)

To change the air flow rate setting. (See page 8.)

To change the air flow direction setting. (See page 10.)

To cancel the "Good Sleep Cooling Operation", press **G-SLEEP**.  
→ Back to the normal cooling operation.

### Notes on "Good sleep cooling operation"

- We adopt the 1/f fluctuation rhythm in temperature control. A 1/f fluctuation rhythm is used in temperature control. With it, temperature is fluctuated within a ±1°C range of the set temperature. The 1/f fluctuation is comfortable rhythm existed in the natural world. (refer to "What's the 1/f fluctuation")
- Air blow is the lowest when the fan is set to "AUTO".
- If you don't like this function, change the operation mode. (See page 8)

### What is 1/f fluctuation...

It seems irregular but there seems to be a self-resemblance rule in our mother nature. For example, the waves in the ocean forms irregularly but when you look at the coast line, there are some places where they look similar. When you look close around you, our heart doesn't beat in regular intervals but shows "1/f fluctuation" in a long term. The research shows this "1/f fluctuation" and comfort has some kind of relation and is applied to the comfort control fields.

12

## Intelligent Eye

"Intelligent Eye" is the infrared sensor which detects the human movement.

1 Press **SENSOR** While the air conditioner is operating. (The Sensor lamp lights up.)

To cancel the "Intelligent Eye", press **SENSOR**. (The Sensor lamp goes off.)

[EX.]  
**When somebody in the room**  
• Normal operation  
(The sensor lamp lights up.)

**When nobody in the room**  
• 20 min. after, start save operation.  
(The sensor lamp goes off.)

**Sombody back in the room**  
• Back to normal operation.  
(The sensor lamp lights up again.)

### "Intelligent Eye" is useful for Energy Saving

- Save operation**
  - Change the temperature -2°C in heat/ +2°C in cool/ +1°C in dry mode from set temperature.
  - Decrease the air flow rate slightly in fan operation.

### Notes on "Intelligent Eye"

- Application range is as follows.
  - Vertical angle 40° (Side View)
  - Horizontal angle 50° (Top View)
- Sensor may not respond when you are 5m or more away. (Check the application range)
- Sensor detection sensitivity changes according to indoor unit location, the speed of passersby, temperature range, etc.
- The sensor also mistakenly detects pets, sunlight, fluttering curtains and light reflected off of mirrors as passersby.

### Adjusting the angle of the Intelligent-eye sensor

- You can adjust the angle of the Intelligent-eye sensor to remove the detection area. (Adjustable angle: 15° to right and left of centre)

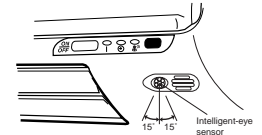

- Gently push and slide the sensor to adjust the angle.



- After adjusting the angle, gently wipe the sensor with a clean cloth, being careful not to scratch the sensor.

### CAUTION

- Do not hit or violently push the Intelligent-eye sensor. This can lead to damage and malfunction.

- Saving operation will not go on during powerful operation.
- Night set mode (see page 11.) will not go on during you use Intelligent Eye.
- You can sleep more comfortably by using "Good Sleep Cooling Operation (G-SLEEP)" function (see page 12.) at the same time.

### CAUTION

- Do not place large objects near the sensor. Also keep heating units or humidifiers outside the sensor's detection area. This sensor can detect objects it shouldn't as well as not detect objects it should.

13

## Care and Cleaning

### CAUTION

Before cleaning, be sure to stop the operation and turn the breaker OFF.

### Cleaning the air filters

(It is recommended to clean them every two weeks.)

#### 1 Open the front grille

- Hold the grille by the tabs on the two sides and lift it until it stops with a click. (about 60°)

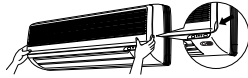

#### 2 Pull out the air filters.

- Push a little upwards the tab at the center of each air filter, then pull it down.



#### 3 Take off the air purifying filters and clean them.

- Wash them with water, or clean them with a vacuum cleaner.
- If the dust does not come off easily, wash them with neutral detergent thinned with lukewarm water, then dry them up in the shade.



#### 4 Set the air purifying filters and the air filters as they were and close the front grille.



- Insert claws of the filters into slots of the front panel. The front grille should lock at both sides and at the point in the middle. Push the grille at the 3 points indicated by ↓.

### NOTE

- In a dusty environment, clean the air filters at least once in every two weeks even before the cleaning lamp lights up.
- Operation with dusty air filters lowers the cooling and heating capacity and wastes energy.

### Cleaning the indoor and outdoor units and the remote controller

- Wipe them with dry soft cloth.
- For cleaning, do not use water hotter than 40° C, benzine, gasoline, thinner, nor other volatile oils, polishing compound, scrubbing brushes nor other hard stuff.

### Replacing air purifying filters

- (It is recommended to replace them every three months.)
- Air purifying filters need to be replaced regularly.

#### 1 Open the front grille and pull out the air filters.

#### 2 Take off the air purifying filters.

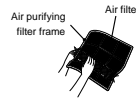

- Hold the recessed parts of the frame and unhook the four claws.

#### 3 Detach the filter element and attach a new one.



#### 4 Attach the air purifying filter.



#### 5 Set the air filters as they were and close the front grille.

(Push the grille at the 3 points, two at both sides and in the middle.)

### NOTE

- To order air purifying filters, contact the service shop where you bought the air conditioner.
- Once the air purifying filter element gets dirty, it is not reusable but must be thrown away.
- Operation with dirty air purifying filters :
  - cannot clean the air.
  - results in poor cooling.
  - may cause odour.

Item	Part No.
Air purifying filter (with frame)	KAF918A41
Air purifying filter (without frame)	KAF918A42

## Care and Cleaning

### Cleaning the front grille

You may remove the front grille for cleaning.

### CAUTION

- When removing or attaching the front grille, use a robust and stable stool and watch your steps carefully.
- When removing or attaching the front grille, support the grille securely with hand to prevent it from falling.
- For cleaning, do not use water hotter than 40° C, benzine, gasoline, thinner, nor other volatile oils, polishing compound, scrubbing brushes nor other hard stuff.
- After cleaning, make sure that the front grille is securely fixed.

#### 1 Open the front grille.

- Hold the grille by the tabs on the two sides and lift it until it stops with a click.

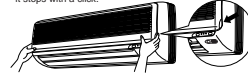

#### 2 Remove the front grille.

- Supporting the front grille with one hand, release the lock by sliding down the knob with the other hand.
- To remove the front grille, pull it toward yourself with both hands.



#### 3 Clean the front grille.

- You may wipe it with a soft cloth soaked in water.
- Only neutral detergent may be used.
- You may wash the grille with water. After washing, dry it with cloth, then dry it up in the shade.

#### 4 Attach the front grille.

- Set the 3 keys of the front grille into the slots and push them in all the way.
- Supporting the front grille with one hand, fit the lock by sliding up the knob with the other hand.
- Close the front grille slowly in this state. (Push the grille at the 3 points, two at both sides and in the middle.)

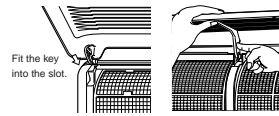

Fit the key into the slot.

Slide up the knob.

### Check

Check that the base, stand and other fittings of the outdoor unit are not decayed or corroded.

Check that nothing blocks the air inlets and the outlets of the indoor unit and the outdoor unit.

Check that the earth wire is not disconnected or broken.

Check that the drain comes smoothly out of the drain hose during COOL or DRY operation.

- If no drain water is seen, water may be leaking from the indoor unit. Stop operation and consult the service shop if this is the case.

### Before a long idle period

- Operate the fan alone for several hours on a fine day to dry out the inside.

<FTK>

- Press **MODE** and select " ".

- Press **ON/OFF**.

<FTX>

- Press **MODE** and select " \* ".

- Press **TEMP** and set the temperature to 32° C.

- Press **ON/OFF**.

- Perform this operation when the room temperature is under 28° C.

- Clean the air filters and set them again.
- Take out batteries from the remote controller.
- Turn OFF the breaker for the room air conditioner.

■ CDK-HA Series

# Names of Parts

## Indoor unit

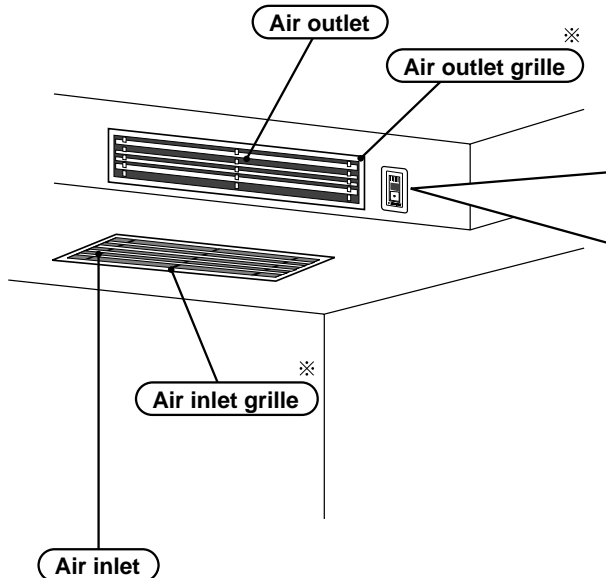

**Air inlet**

- There are models which are not equipped with the air filter inside of the unit.
- Clean the air filter periodically. (See page 11 "Care and Cleaning".)

※ Appearance of the Air outlet grille and Air inlet grille may differ with some models.

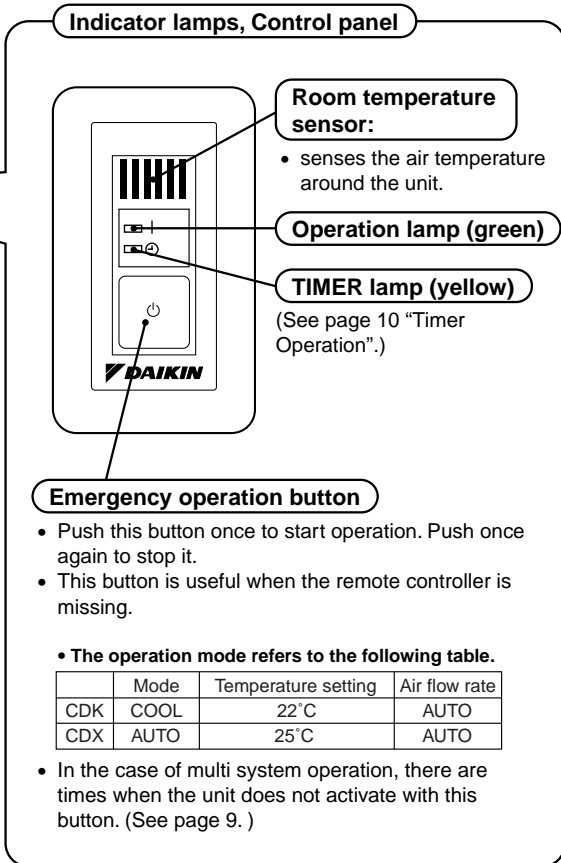

## Outdoor unit

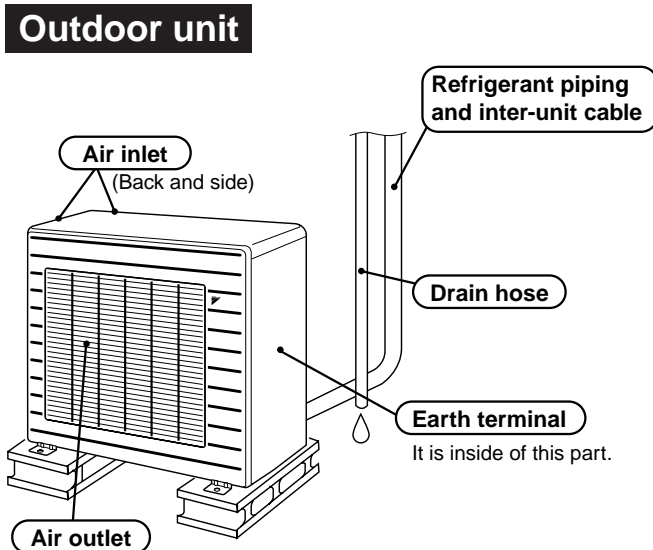

Appearance of the outdoor unit may differ with some models.

<2MK><3MK><4MK>  
<2MX><3MX><4MX>

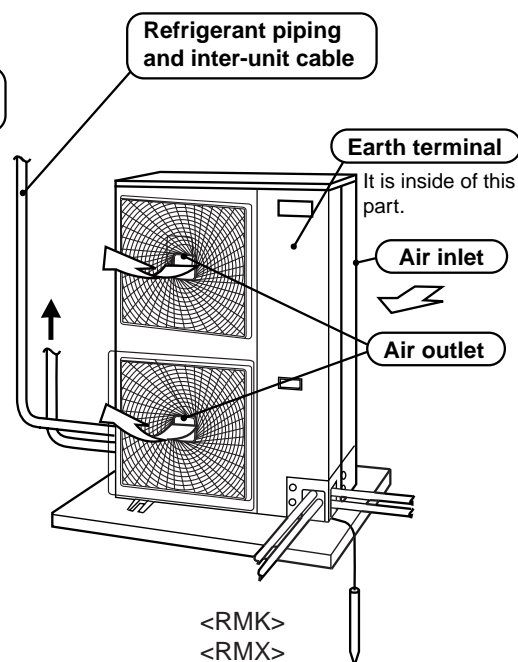

<RMK>  
<RMX>

# Names of Parts

## Remote controller

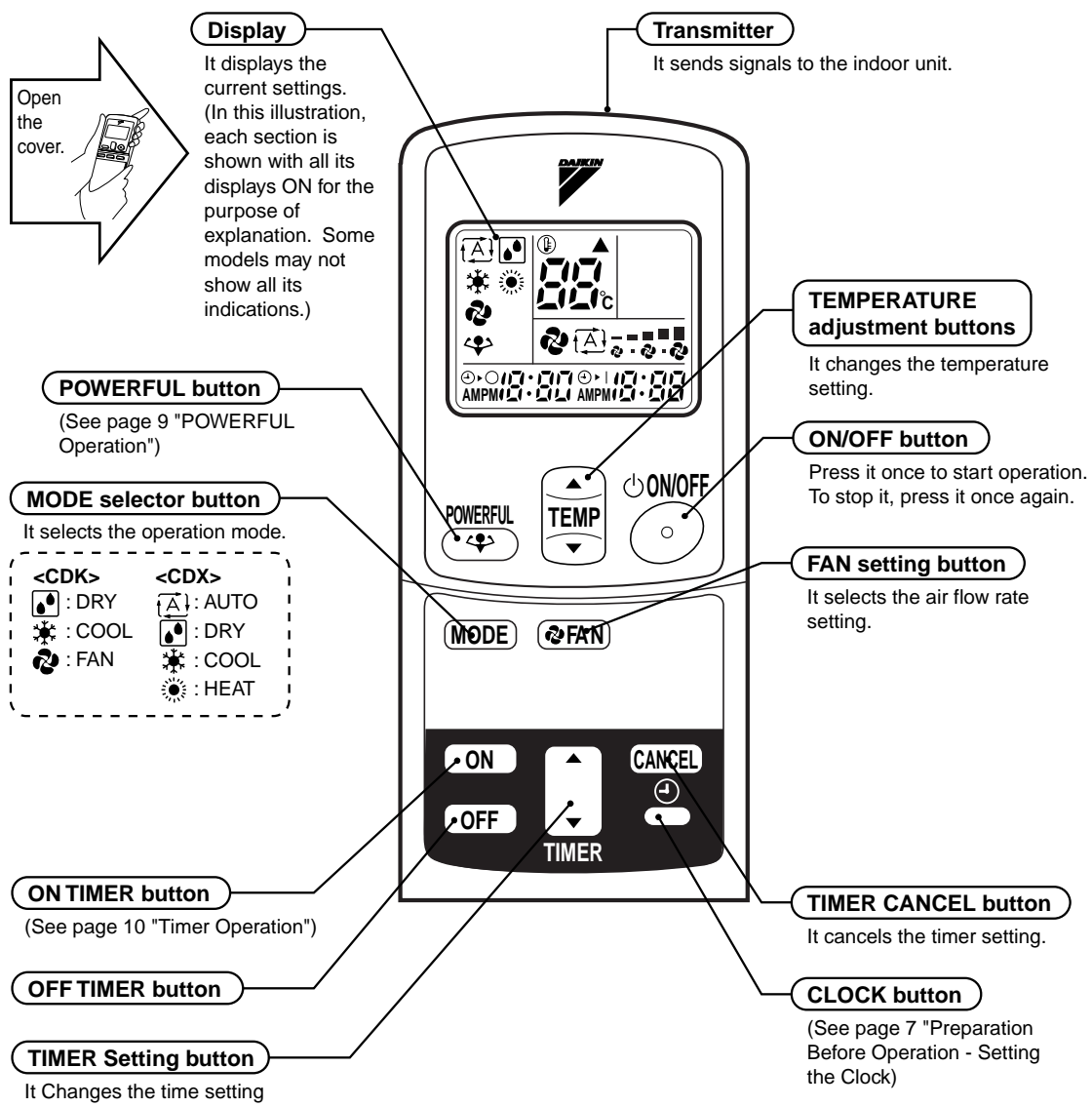

<ARC423A11 ARC423A12>

## Preparation Before Operation

### Remote controller

#### Setting the batteries

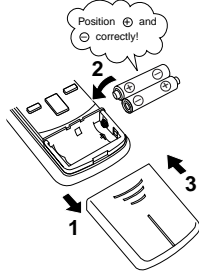

- Press with a finger and slide the back cover to take it off.
- Set two dry batteries (AAA).
- Set the back cover as before.
  - This will cause the figures on the display to flash. Set the clock at this point.

#### ATTENTION

##### About batteries

- When replacing the batteries, use batteries of the same type, and replace the two old batteries together.
- When the system is not used for a long time, take the batteries out.
- When the operation display screen of the remote controller is hard to see and the reception becomes hard, replace the batteries with new AAA batteries.
- The attached batteries are provided for the initial use of the system. The usable period of the batteries may be short depending on the manufactured date of the air conditioner.

#### Operating the remote controller

- To use the remote controller, aim the transmitter at the indoor unit. If there is anything to block signals between the unit and the remote controller, such as a curtain, the unit will not operate.
- Do not drop the remote controller. Do not get it wet.
- The maximum distance for communication is about 7 m.

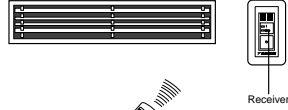

#### To fix the remote controller holder on the wall

- Choose a place from where the signals reach the unit.
- Fix the holder to a wall, a pillar, etc. with the screws supplied with the holder.
- Fit the claw of the holder into the bottom of the remote controller, and push the remote controller onto the wall.

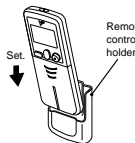

- To remove, pull it upwards.

#### ATTENTION

##### About the remote controller

- Never expose the remote controller to direct sunlight.
- Dust on the signal transmitter or receiver will reduce the sensitivity. Wipe off dust with soft cloth.
- Signal communication may be disabled if an electronic-starter-type fluorescent lamp (such as inverter-type lamps) is in the room. Consult the shop if that is the case.
- If the remote control signals happen to operate another appliance, move that appliance to somewhere else, or consult the shop.

## Preparation Before Operation

#### Setting the clock

- Press .
  - AM 0:00 is displayed.
  - blinks.

- Press to set the clock to the present time.
  - TIMER



- Pressing or button

rapidly increases or decreases the time display.

- Press .
  - blinks.
  - (Now the clock is set.)

#### Indoor unit

#### Turn the breaker ON

- Turning ON the breaker opens the flap, then closes it again. (This is a normal procedure.)

#### NOTE

##### Tips for saving energy

- Be careful not to cool the room too much. Keeping the temperature setting at a moderate level helps save energy.

##### Recommended temperature setting

For cooling: 26°C - 28°C  
For heating: 20°C - 24°C

- Cover windows with a blind or a curtain. Blocking sunlight and air from outdoors increases the cooling effect.
- Clogged air filters cause inefficient operation and waste energy. Clean them once in about every two weeks.

##### Please note-

- The air conditioner always consumes 15 - 35 watts of electricity even while it is not operating.
- If you are not going to use the air conditioner for a long period, for example in spring or autumn, turn the breaker OFF.
- Use the air conditioner in the following conditions.

Mode	Operating conditions	If operation is continued out of this range:
COOL	Outdoor temperature -> 10 to 46°C	* A safety device may work to stop the operation. (In multi-systems it may work to stop the operation of the outdoor unit only.) * Condensation may occur on the indoor unit and drip.
	Outdoor temperature controls with 2-4RM outdoor: 2-4RM	
	RMK -> 5 to 46°C	
HEAT	Outdoor temperature -> -10 to 21°C	* A safety device may work to stop the operation.
	Outdoor temperature controls with 2-4RM outdoor: -10 to 21°C	
	RMK -> -15 to 21°C	
DRY	Outdoor temperature -> 21 to 46°C	* A safety device may work to stop the operation. * Condensation may occur on the indoor unit and drip.
	Outdoor temperature controls with 2-4RM outdoor: 21 to 46°C	
	RMK -> 5 to 46°C	
	Indoor temperature -> 18 to 32°C	
	Indoor humidity -> 80% max.	

- Operation outside this humidity or temperature range may cause a safety device to disable the system.

6

7

## AUTO • DRY • COOL • HEAT • FAN Operation

The air conditioner operates with the settings of your choice. From the next time on, the air conditioner will operate with the same settings.

- Press **MODE** and select a mode.



- Each pressing of the button advances the mode setting in sequence.

-CDK->

-CDK->

-CDK->

-CDK->

-CDK->

-CDK->

-CDK->

-CDK->

-CDK->

-CDK->

-CDK->

-CDK->

-CDK->

-CDK->

-CDK->

-CDK->

-CDK->

-CDK->

-CDK->

-CDK->

-CDK->

-CDK->

-CDK->

-CDK->

-CDK->

-CDK->

-CDK->

-CDK->

-CDK->

-CDK->

-CDK->

#### To change the air flow rate setting:

Press **FAN**.

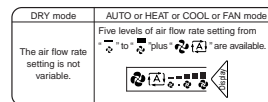

- At smaller air flow rates, cooling or heating effect is also smaller.

#### NOTE

**<Note on HEAT mode operation>**  
Since this air conditioner heats the room by taking heat from outdoor air to indoors, the heating capacity becomes smaller in lower outdoor temperatures. If the heating effect is insufficient, it is recommended to use another heating appliance in combination with the air conditioner.

The heat pump system heats the room by circulating hot air around all parts of the room. After the start of heating operation, it takes some time before the room gets warmer.

In heating operation, frost may occur on the outdoor unit and lower the heating capacity. In that case, the system switches into defrosting operation to take away the frost. During defrosting operation, hot air does not flow out of indoor unit.

**<Note on DRY mode operation>**  
This operation dehumidifies the indoor air when it is humid.

**<Note on AUTO operation>**  
In AUTO operation, the system selects a temperature setting and an appropriate mode (COOL or HEAT) based on the room temperature at the start of the operation.

The system automatically reselects setting at a regular interval to bring the room temperature to user-setting level. If you do not like AUTO operation, you can select manually, you like the mode and setting.

## POWERFUL Operation

POWERFUL operation quickly maximizes the cooling and heating effect in any operation mode. You can get the maximum capacity with a touch of a button.

- Pressing the **POWERFUL** button during operation starts POWERFUL operation.
- POWERFUL operation ends in 20 minutes. Then the system automatically operates again with the settings which were used before POWERFUL operation.

- Press .

#### To cancel POWERFUL operation:

- Press .

#### Notes on POWERFUL operation

- In COOL and HEAT mode**  
To maximize the cooling and heating effect, the capacity of outdoor unit must be increased and the air flow rate be fixed to the maximum setting. The temperature and air flow settings are not variable.
- In DRY mode**  
The temperature setting is lowered by 1°C and the air flow rate is slightly increased.
- In FAN mode**  
The air flow rate is fixed to the maximum setting.

## Note for Multi System

#### Preference-room setting

When setting the preference-room during installation, the indoor unit's operation mode always takes priority. When the preference-setting room unit is operated in POWERFUL mode, there are times that air conditioners in other rooms will temporarily stop in order to centralize power to the unit in the room.

Please adjust the preference-room setting to match your life style. Moreover, for preference-room settings, please consult the service shop where you bought the unit.

\* Preference-room setting is applied to only 4MX40, 4MK90.

#### COOL/HEAT mode

This mode is used to set the unit to only cool or heat. For information on using this mode, consult the service shop where you bought the unit.

\* COOL/HEAT mode is applied to only 4MX40, 4MK90.

#### NOTE

##### <Note for heat pump multi system>

When two or more indoor units have no preference-room settings and are set to modes that differ from each other, the indoor unit which is operated first activates, while the other indoor unit does not activate and the OPERATION lamp blinks. (This is not a malfunction.)

An indoor unit that is not in operation will automatically start and operate in the mode in which a previously operated indoor unit was stopped. However, if the unit in operation provides only COOL and DRY modes, simultaneous operation is possible.

#### Precautions for outdoor unit connected to RMK(X)140

- In heating operation, when all indoor units are stopped, the outdoor unit stops its operation automatically after 5 minutes. This is a part of preparation process for the next operation, not a failure.
- In heating operation, no warm air may come out temporarily. This is for an oil recovery operation performed at certain time intervals, not a failure.
- In simultaneous operation at two or more rooms, when heating operation is performed at one room, cooling operation cannot be performed at other rooms. Whichever mode selected first is preferred.

8

9

## Timer Operation

Timer functions are useful for automatically switching the air conditioner on or off at night or in the morning. You can also use OFF TIMER and ON TIMER in combination.

### OFF TIMER operation

- Check that the clock is correct. If not, set the clock to the present time. (See page 7.)

**1** Press **OFF** while the air conditioner is operating.  
 AM 7:00 is displayed.  
 The clock icon blinks.  
 \*Previous time setting appears on display.

**2** Press **TIMER** until the time setting reaches the point you like.  
 ● Every pressing of either button increases or decreases the time setting by 10 minutes. Holding down either button changes the setting rapidly.

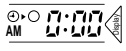
**3** Press **OFF** once again.  
 AM 7:00  
 Then the TIMER lamp lights up.

**To cancel the timer:**  
 Press **CANCEL**. Then the TIMER lamp goes off.

### Notes on OFF TIMER

- **NIGHT SET MODE**  
 When the OFF TIMER is set, the air conditioner automatically adjusts the temperature setting (0.5°C up in COOL, 2.0°C down in HEAT) to prevent excessive cooling (heating) for your pleasant sleep.

### ON TIMER operation

- Check that the clock is correct. If not, set the clock to the present time. (See page 7.)

**1** Press **ON** while the air conditioner is not operating.  
 AM 6:00  
 AM 6:00 is displayed.  
 The clock icon blinks.

**2** Press **TIMER** until the time setting reaches the point you like.  
 ● Every pressing of either button increases or decreases the time setting by 10 minutes. Holding down either button changes the setting rapidly.

**3** Press **ON** once again.  
 AM 7:00  
 Then the TIMER lamp lights up.

### To cancel the timer:

Press **CANCEL**.  
 Then the TIMER lamp goes off.

### Combining ON TIMER and OFF TIMER

- A sample setting for combining the two timers is shown below.

(Example)  
 Present time: 11:00 PM  
 (The unit operating)  
 OFF TIMER at 0:00 a.m.)  
 ON TIMER at 7:00 a.m.) Combined



### Notes on ON/OFF TIMER

- When TIMER is set, the present time is not displayed.
- Once you set ON/OFF TIMER, the time setting is kept in the memory. (The memory is canceled when remote controller batteries are replaced.)

### ATTENTION

- In the following cases, set the timer again.
  - After a breaker has turned OFF.
  - After a power failure.
  - After replacing batteries in the remote controller.

## Care and Cleaning

**CAUTION**  
 Before cleaning, be sure to stop the operation and turn the breaker OFF.

### Cleaning the air filters

- There are models which are not equipped with the air filter inside of the unit.

(It is recommended to clean them every two weeks.)

- 1 Remove the air inlet grille.
- 2 Pull out the air filters.
- 3 Clean the air filters.
  - Clean them with a vacuum cleaner.
- 4 Set the air filters and the air inlet grille as they were.

### NOTE

- In a dusty environment, clean the air filters at least once in every two weeks.
- Operation with dusty air filters lowers the cooling and heating capacity and wastes energy.

### Check

Check that the base, stand and other fittings of the outdoor unit are not decayed or corroded.

Check that nothing blocks the air inlets and the outlets of the indoor unit and the outdoor unit.

Check that the earth wire is not disconnected or broken.

Check that the drain comes smoothly out of the drain hose during COOL or DRY operation.

- If no drain water is seen, water may be leaking from the indoor unit. Stop operation and consult the service shop if this is the case.

### Before a long idle period

- 1 Operate the fan alone for several hours on a fine day to dry out the inside.

<CDK>

**1** Press **MODE** and select "  ".

**2** Press **ON/OFF**.

<CDX>

**1** Press **MODE** and select "  ".

**2** Press **TEMP** and set the temperature to 32°C

**3** Press **ON/OFF**.

- Perform this operation when the room temperature is under 28°C.

- 2 Clean the air filters and set them again.
- 3 Take out batteries from the remote controller.
- 4 Turn OFF the breaker for the room air conditioner.