

- Warning**  ● Ask a qualified installer or contractor to install this product. Do not try to install the product yourself. Improper installation can result in water or refrigerant leakage, electrical shock, fire or explosion.
- Use only those parts and accessories supplied or specified by Daikin. Ask a qualified installer or contractor to install those parts and accessories. Use of unauthorised parts and accessories or improper installation of parts and accessories can result in water or refrigerant leakage, electrical shock, fire or explosion.
  - Read the user's manual carefully before using this product. The user's manual provides important safety instructions and warnings. Be sure to follow these instructions and warnings.

If you have any enquiries, please contact your local importer, distributor and/or retailer.

#### Cautions on product corrosion

1. Air conditioners should not be installed in areas where corrosive gases, such as acid gas or alkaline gas, are produced.
2. If the outdoor unit is to be installed close to the sea shore, direct exposure to the sea breeze should be avoided. If you need to install the outdoor unit close to the sea shore, contact your local distributor.

# AIR COOLED PACKAGED AIR CONDITIONERS

**FLOOR STANDING TYPE  
DUCT TYPE**

COOLING ONLY 50Hz

**R-410A**



**DUCT TYPE**  
FDR05-20NY1G (IE3 Motor)

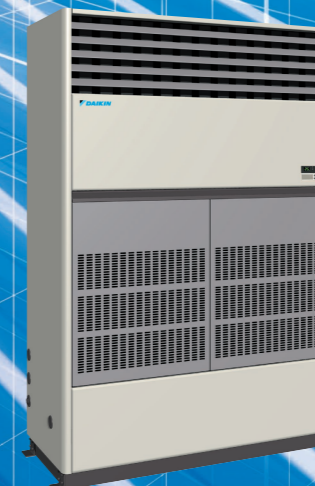

**DIRECT AIR BLOW TYPE**  
FVGR05-10NV1



**DUCT CONNECTION TYPE**  
FVPGR10-20NY1G (IE3 Motor)

**Suitable for  
factories**

**FLOOR STANDING TYPE**

**IE3 MOTOR VERSION**

# HFC R-410A Line Up for Factories and Offices

We have entered an era in which being recognized as an environmentally responsible corporate citizen has taken utmost importance.

Even when selecting air conditioners, a new model featuring HFC R-410A refrigerant could be the perfect step in promoting your corporate image.

## DIRECT AIR BLOW TYPE

Direct air blow from indoor unit with plenum

- Comfortable factory air conditioning using multiple indoor units installed in accordance with the space.
- Installation is next to walls, so units will not affect the factory layout even if the changes are made.

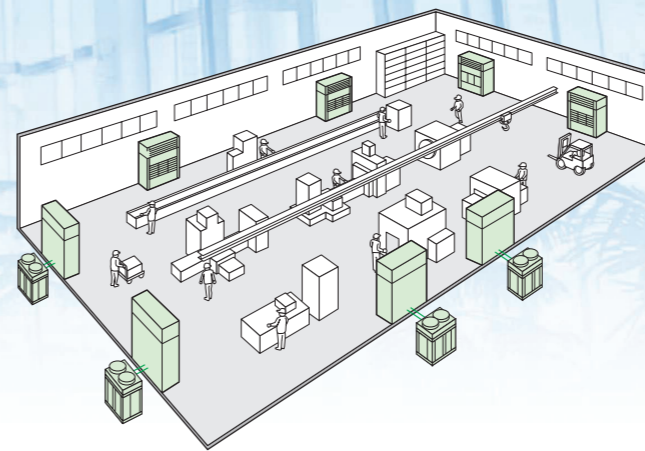

## DUCT CONNECTION TYPE

### DUCT TYPE

Air blow via connected ducts

- Comfortable air conditioning of the entire factory by connecting a blow duct at the top of the indoor unit.

Note: Ducts to be procured locally.

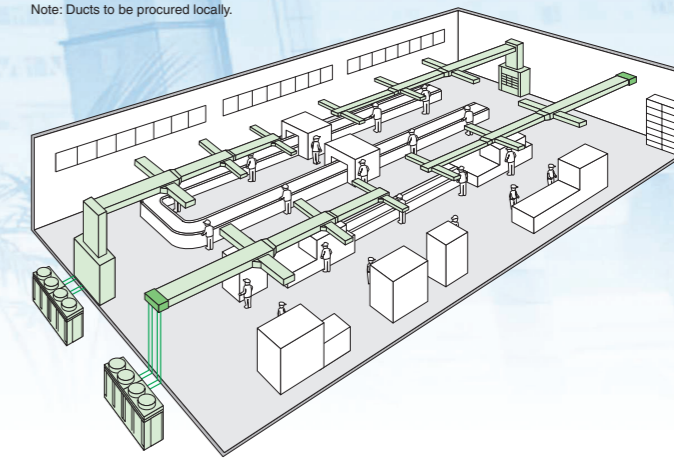

## Product Line Up **R-410A**

FLOOR STANDING TYPE **Cooling only**

50Hz

		5	6	8	10	13	15	18	20
<b>Capacity</b> <sup>1,2</sup>	HP	5	6	8	10	13	15	18	20
	kW	14.7	17.6	23.5	29.3	35.2	46.9	52.8	58.6
	Btu/h	50,000	60,000	80,000	100,000	120,000	160,000	180,000	200,000
	kcal/h	12,600	15,100	20,200	25,200	30,200	40,300	45,400	50,400
<b>FLOOR STANDING TYPE</b> DIRECT AIR BLOW TYPE <small>Specifications Page 5 Dimensions Page 10</small>	Indoor unit	FVGR05NV1	FVGR06NV1	FVGR08NV1	FVGR10NV1				
	Outdoor unit	RUR05NY1	RUR06NY1	RUR08NY1	RUR10NY1				
<b>FLOOR STANDING TYPE</b> DUCT CONNECTION TYPE <b>IE3</b> <small>Specifications Page 5 Dimensions Page 11</small>	Indoor unit				FVPGR10NY1G	FVPGR13NY1G	FVPGR15NY1G	FVPGR18NY1G	FVPGR20NY1G
	Outdoor unit				RUR10NY1	RUR13NY1	RUR15NY1	RUR18NY1	RUR20NY1
<b>OUTDOOR UNIT</b> <small>Dimensions Page 14,15</small>									

Nice,  
cool air in the factory  
or in the cafeteria



DUCT TYPE **Cooling only**

50Hz

		5	6	8	10	13	15	18	20
<b>Capacity</b> <sup>1,2</sup>	HP	5	6	8	10	13	15	18	20
	kW	14.7	17.6	23.5	29.3	35.2	46.9	52.8	58.6
	Btu/h	50,000	60,000	80,000	100,000	120,000	160,000	180,000	200,000
	kcal/h	12,600	15,100	20,200	25,200	30,200	40,300	45,400	50,400
<b>DUCT TYPE</b> <b>IE3</b> <small>Specifications Page 6 Dimensions Page 12,13</small>	Indoor unit	FDR05NY1G	FDR06NY1G	FDR08NY1G	FDR10NY1G	FDR13NY1G	FDR15NY1G	FDR18NY1G	FDR20NY1G
	Outdoor unit	RUR05NY1	RUR06NY1	RUR08NY1	RUR10NY1	RUR13NY1	RUR15NY1	RUR18NY1	RUR20NY1
<b>OUTDOOR UNIT</b> <small>Dimensions Page 14,15</small>									

Note: <sup>1</sup>Rated cooling capacities are based on the following conditions: Return air temp., 27°CDB, 19.5°CWB; outdoor temp. 35°CDB. Equiv. refrigeration piping, 5 m (horizontal).  
<sup>2</sup>Capacity includes indoor fan motor heat.



# Flexible design and great reliability.

## FLOOR STANDING TYPE DIRECT AIR BLOW TYPE

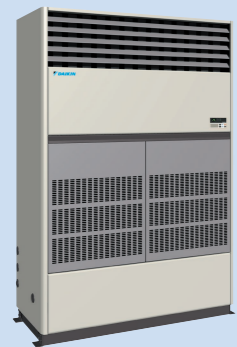

FVGR10NV1



RUR10NY1

## DUCT CONNECTION TYPE



FVPGR10NY1G



RUR10NY1

## DUCT TYPE

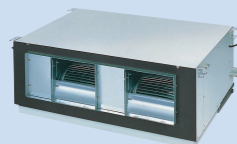

FDR10NY1G



RUR10NY1

## Enhanced varieties of factory modification and optional accessories

○ Standard model  
□ Factory modification

	Floor Standing Type		Duct Type
	Direct Air Blow	Duct Connection Type	
Auto restart	□	□	○
Modify wiring for central control adaptor kit (DTA107A55) installation	□	□	○
Discharge grill plenum chamber	○	□	-
Side discharge grill discharge plenum chamber	□	□	-
Front suction high efficiency filter chamber	-	□	-
Front suction base flange for front suction high efficiency filter chamber	-	□	-
Suction grill for front suction high efficiency filter chamber	-	□	-
Rear suction	□	□	-
Drain pump	□	□	-
Remote sensor (Thermistor for suction air)	□	□	-
Central control adaptor kit (external terminal for ON/OFF, abnormal) <sup>1</sup>	DTA107A55		
LCD remote controller <sup>2</sup>	BRC1C62		
intelligent Touch Controller <sup>2</sup>	DCS601C51		
Central remote controller <sup>2</sup>	DCS302CA61		
Unified ON/OFF controller <sup>3</sup>	DCS301B61		
Schedule timer <sup>3</sup>	DST301BA61		
Remote sensor (thermistor for suction air) <sup>3</sup>	KRCS01-1B		
Remote controller	-	-	BRC1NU64

Note:  
<sup>1</sup>Wiring modification is needed on floor stand model to connect with central control ADP kit.  
<sup>2</sup>Need to use central control adaptor kit for option connection.  
<sup>3</sup>Central control adaptor kit and LCD remote controller is necessary for option connection.

## Easy operation

Digital remote control comes standard with indoor unit.

Temperature setting is possible by button operation. The set temperature is conveniently displayed on the LED.

Floor standing type (Standard accessory)

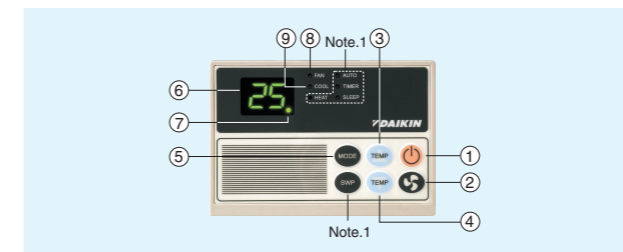

- ① On/Off button
- ② Fan button
- ③ Temp. setting up
- ④ Temp. setting down
- ⑤ Mode button
- ⑥ LED display
- ⑦ Compressor operation lamp.
- ⑧ Fan operation lamp.
- ⑨ Cool operation lamp.

Note.1 It cannot be used for FVPGR10-20NY1G

Duct type (optional accessory)

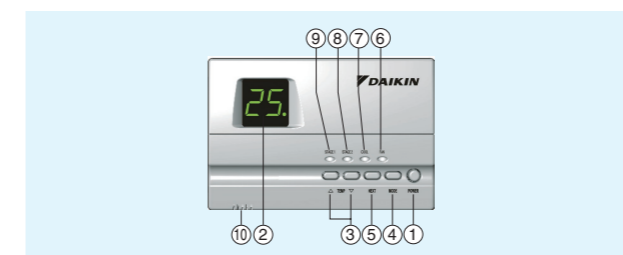

- ① Power
- ② Temperature scale
- ③ Temperature setting
- ④ Mode setting
- ⑤ Next setting
- ⑥ Fan indicator lamp
- ⑦ Cool indicator lamp
- ⑧ Compressor 2 indicator lamp
- ⑨ Compressor 1 indicator lamp
- ⑩ Temperature sensor

## Refrigerant pre charged for up to 7.5 metres

Allowable refrigerant pipe length and level difference

	Pre-charged <sup>1</sup>	Max. length	Max. level difference
RUR05NY1-20NY1	7.5 m	50 m (Equivalent length 70 m)	30 m

Note: <sup>1</sup>Additional refrigerant charging is required if the refrigerant pipe is longer than the indicated length.

## 4-direction piping affords more freedom of layout

(Applies to RUR05N/06N)

Piping can be run from the front, bottom, right or rear surface according to how the unit is installed.

In case of RUR08-20N, piping can be drawn out in two directions-front, and under side.

## Durability

### Heat exchange fins provided with anti-corrosion treatment

(Applies to all outdoor units)

To achieve increased durability by improved resistance to salt corrosion and atmospheric pollution, coated PE fins (with special acrylic pretreatment) are used for the heat exchanger of the outdoor unit.

## Space savings

Installation space is saved thanks to a more compact outdoor unit. This also makes it easier to install.

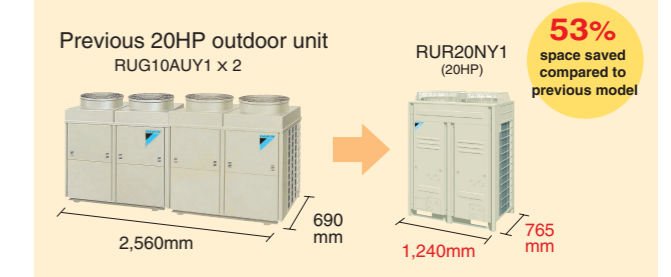

## IE3 Fan Motor **NEW**

Reliability, long life and premium efficiency motor

Reduce energy consumption, CO<sub>2</sub> emissions and the impact of industrial operations on the environment.

For FVPGR10-20NY1G  
FDR5-20NY1G



## Quiet Operation

Equipped with scroll compressor for quiet operation

Smooth running, low vibration, low operating sound.

Outdoor unit	Sound level	
	380V	415V
RUR05NY1	59 dB	60 dB
RUR06NY1	59 dB	60 dB

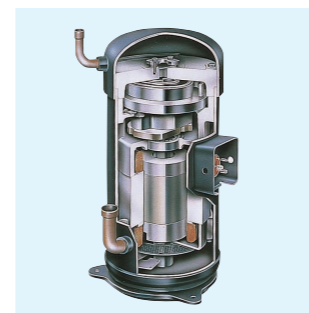

## Design flexibility

Designed for long refrigerant piping.

50 m maximum length and 30 m maximum level difference to cover medium- and large-scale building needs.

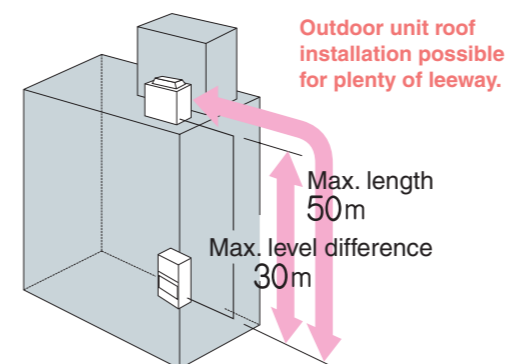



# Fan Performance

## FLOOR STANDING TYPE DUCT CONNECTION TYPE

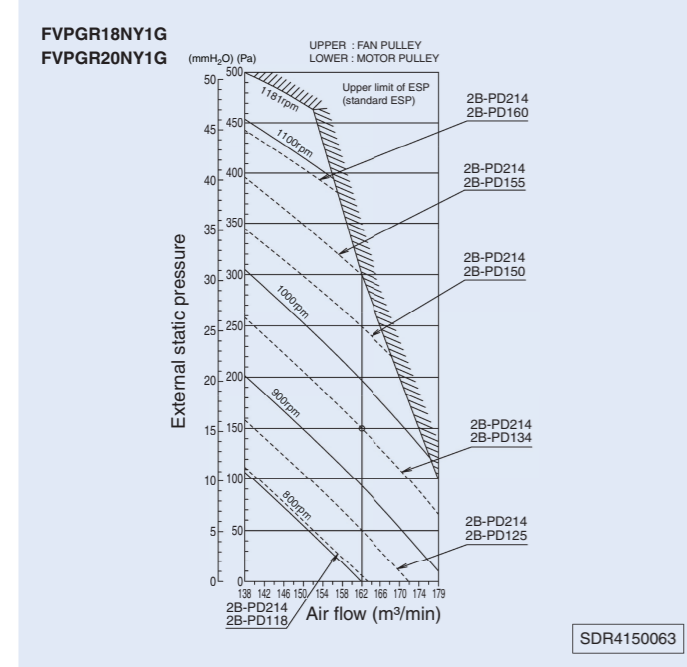
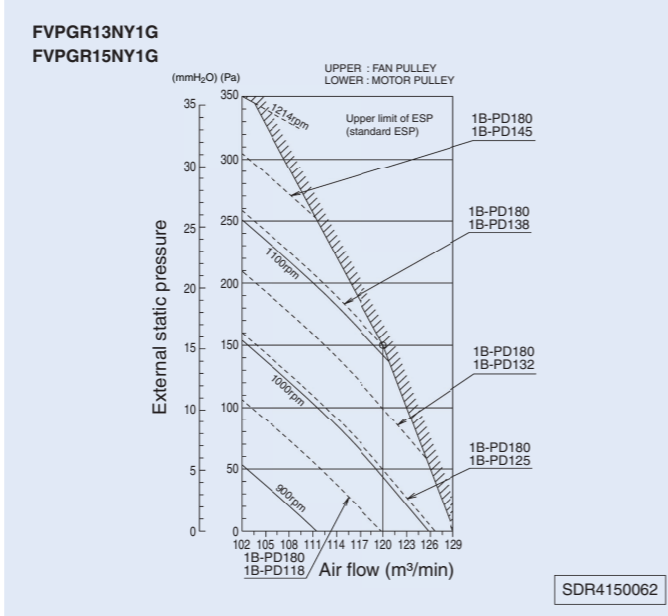
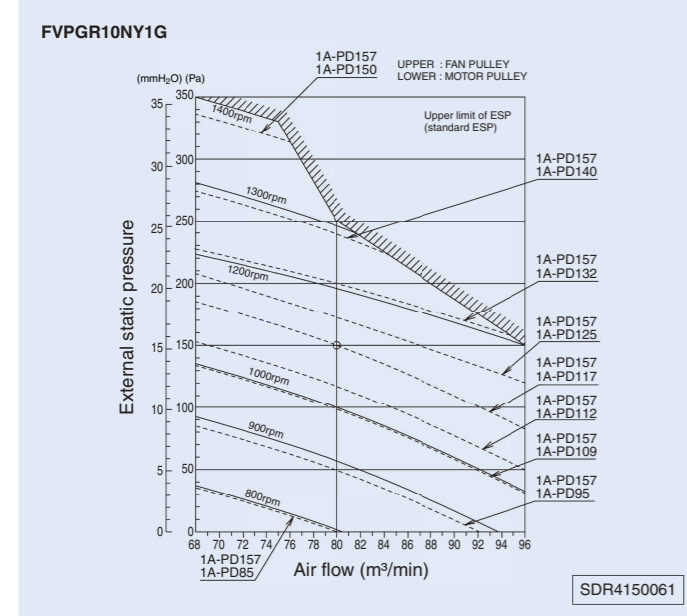

## DUCT TYPE

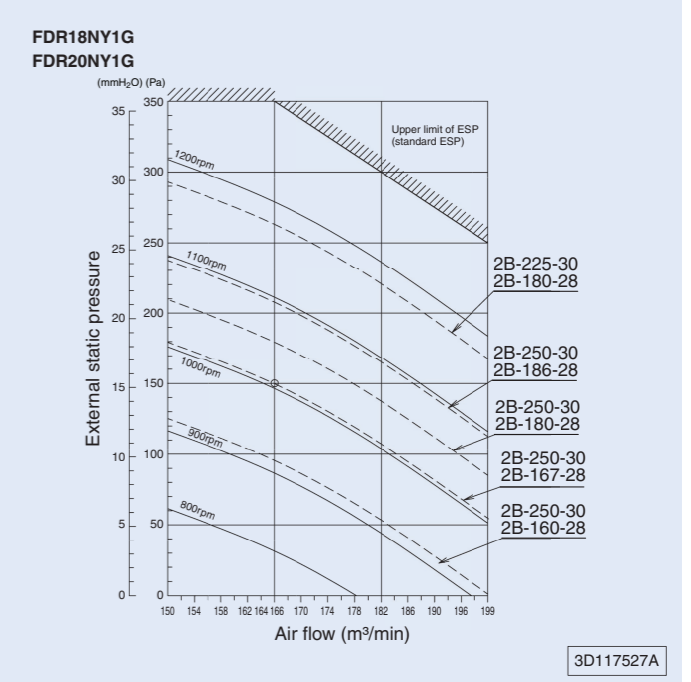
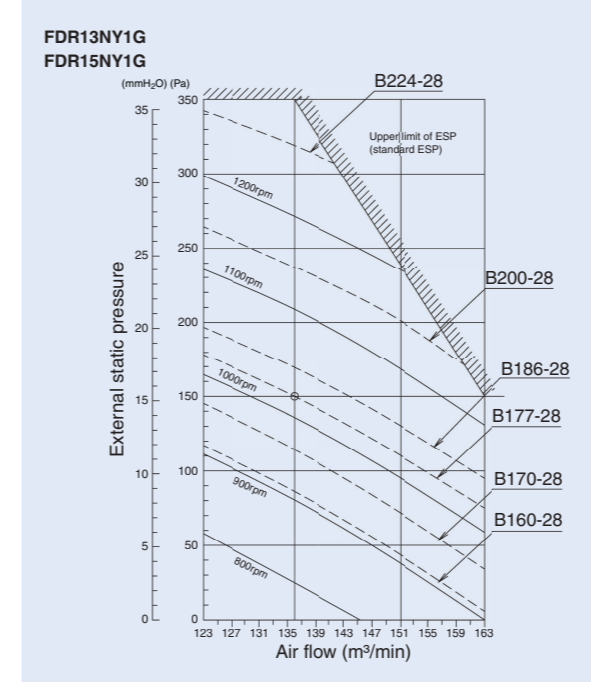
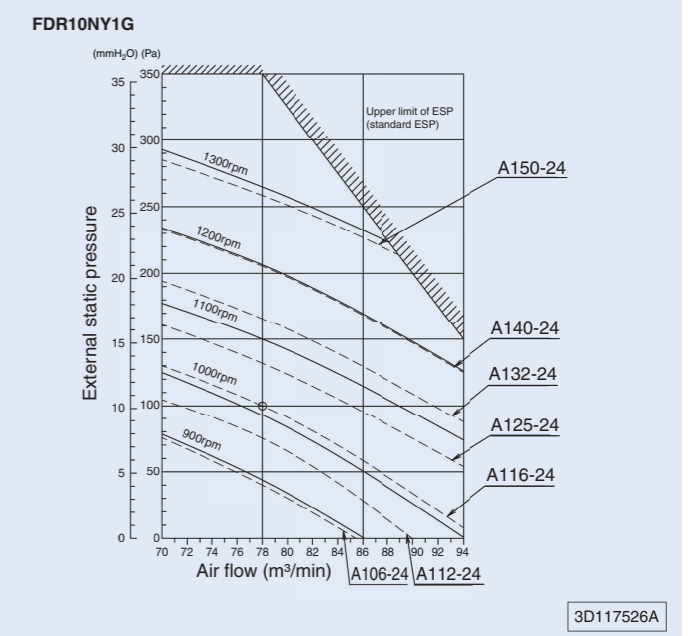
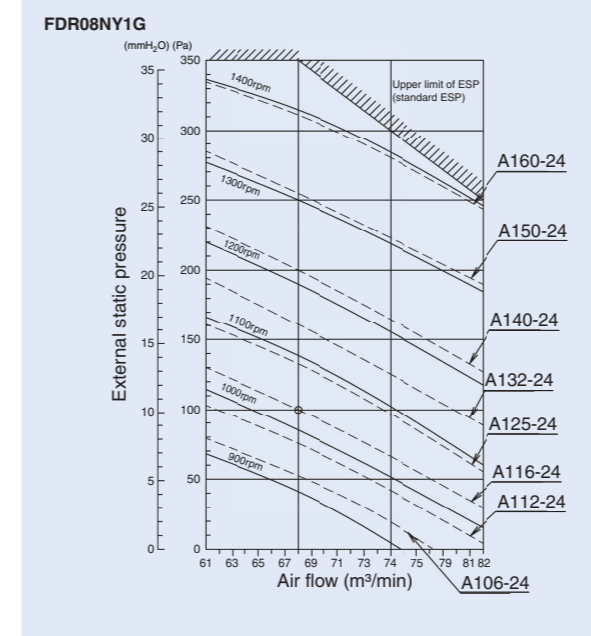
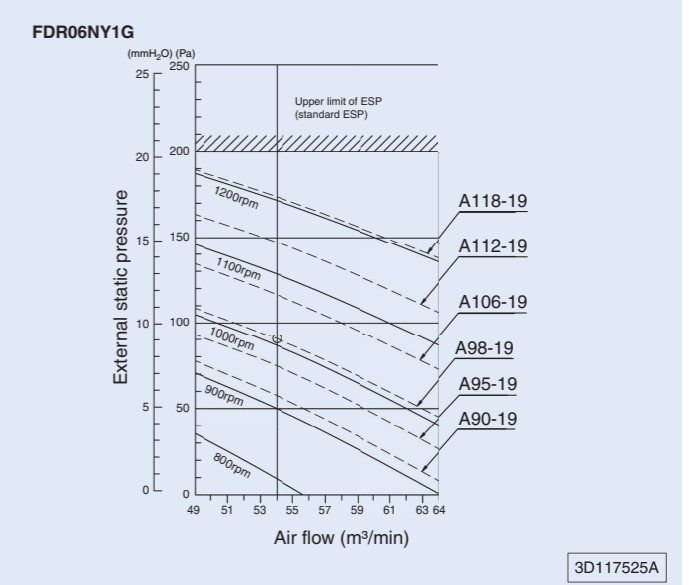
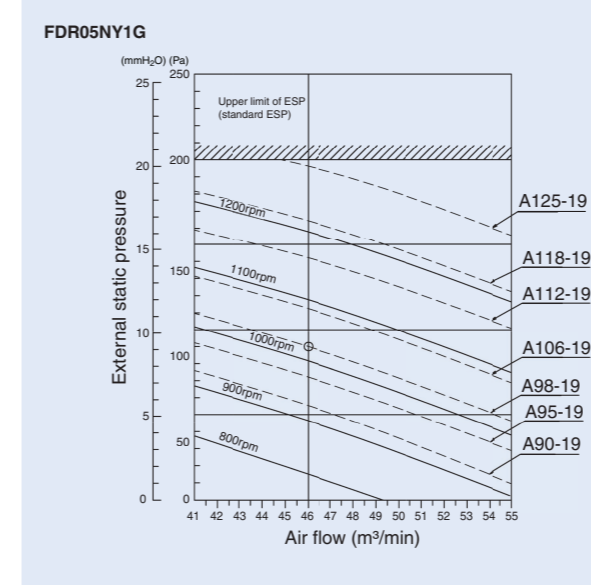

## ■ FLOOR STANDING TYPE DIRECT AIR BLOW TYPE

FVGR05N/06NV1  
RUR05N/06NY1

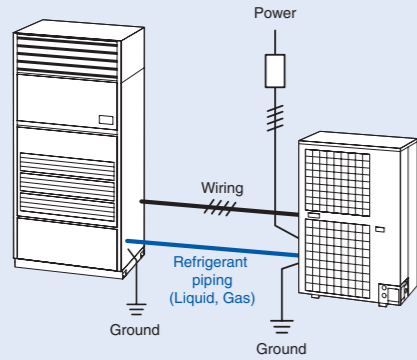

FVGR08N/10NV1  
RUR08N/10NY1

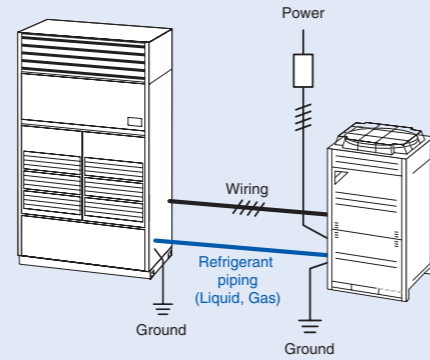

## DUCT CONNECTION TYPE

FVPR10NY1G  
RUR10NY1

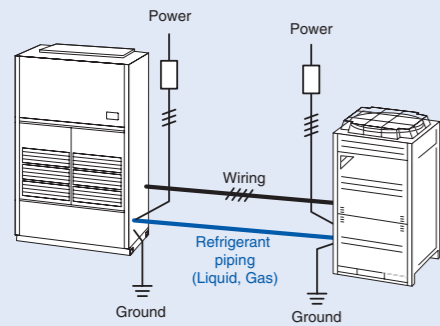

FVPR13N/15N/18N/20NY1G  
RUR13N/15N/18N/20NY1

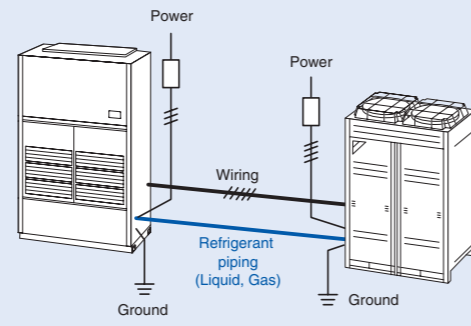

## ■ DUCT TYPE

FDR05N/06NY1G  
RUR05N/06NY1

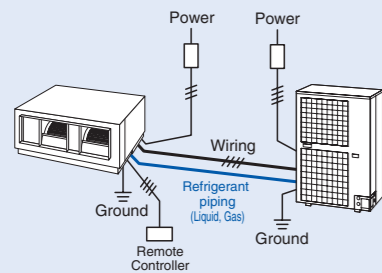

FDR08N/10NY1G  
RUR08N/10NY1

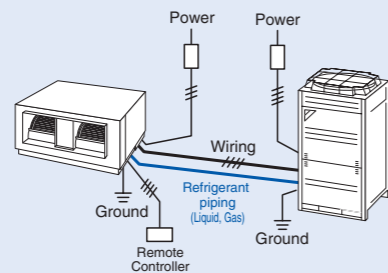

FDR13N/15N/18N/20NY1G  
RUR13N/15N/18N/20NY1

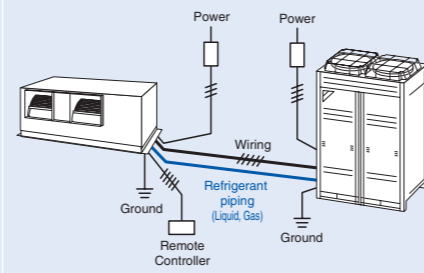

## ■ FLOOR STANDING TYPE DIRECT AIR BLOW TYPE

FVGR05NV1  
FVGR06NV1  
FVGR08NV1

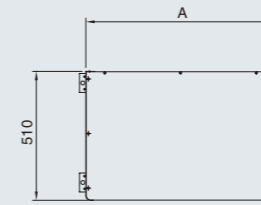

	A	B	C	D
FVGR05NV1	750	720	φ9.5	φ19.1
FVGR06NV1	750	720	φ9.5	φ19.1
FVGR08NV1	950	920	φ12.7	φ22.2

- ① Liquid pipe conn. (C) C1220T brazing
- ② Gas pipe conn. (D) C1220T brazing
- ③ Upper drain outlet (PS 1B Internal thread)
- ④ Power supply & control wire intake
- ⑤ Digital remote controller

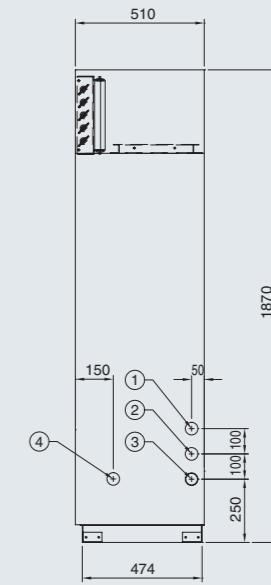
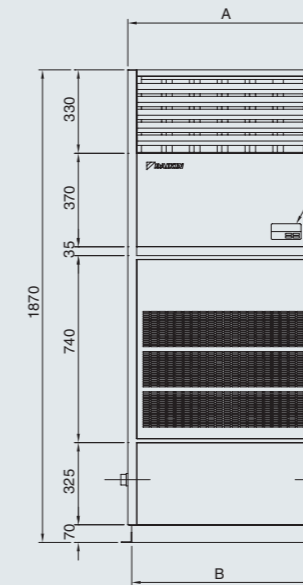

SDR3150151C  
SDR3150152B  
SDR3150153C

FVGR10NV1

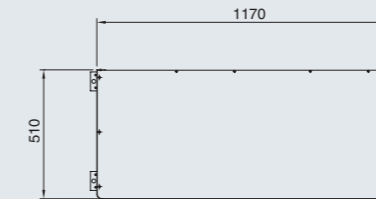

- ① Liquid pipe conn. (φ 12.7) C1220T brazing
- ② Gas pipe conn. (φ 28.6) C1220T brazing
- ③ Upper drain outlet (PS 1B Internal thread)
- ④ Power supply & control wire intake
- ⑤ Digital remote controller

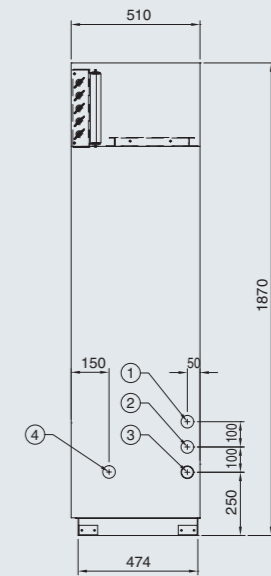
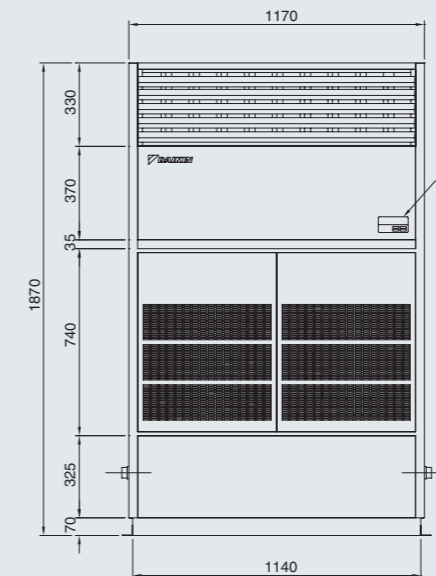

SDR3150154C

## DUCT CONNECTION TYPE

### FVPGR10NY1G

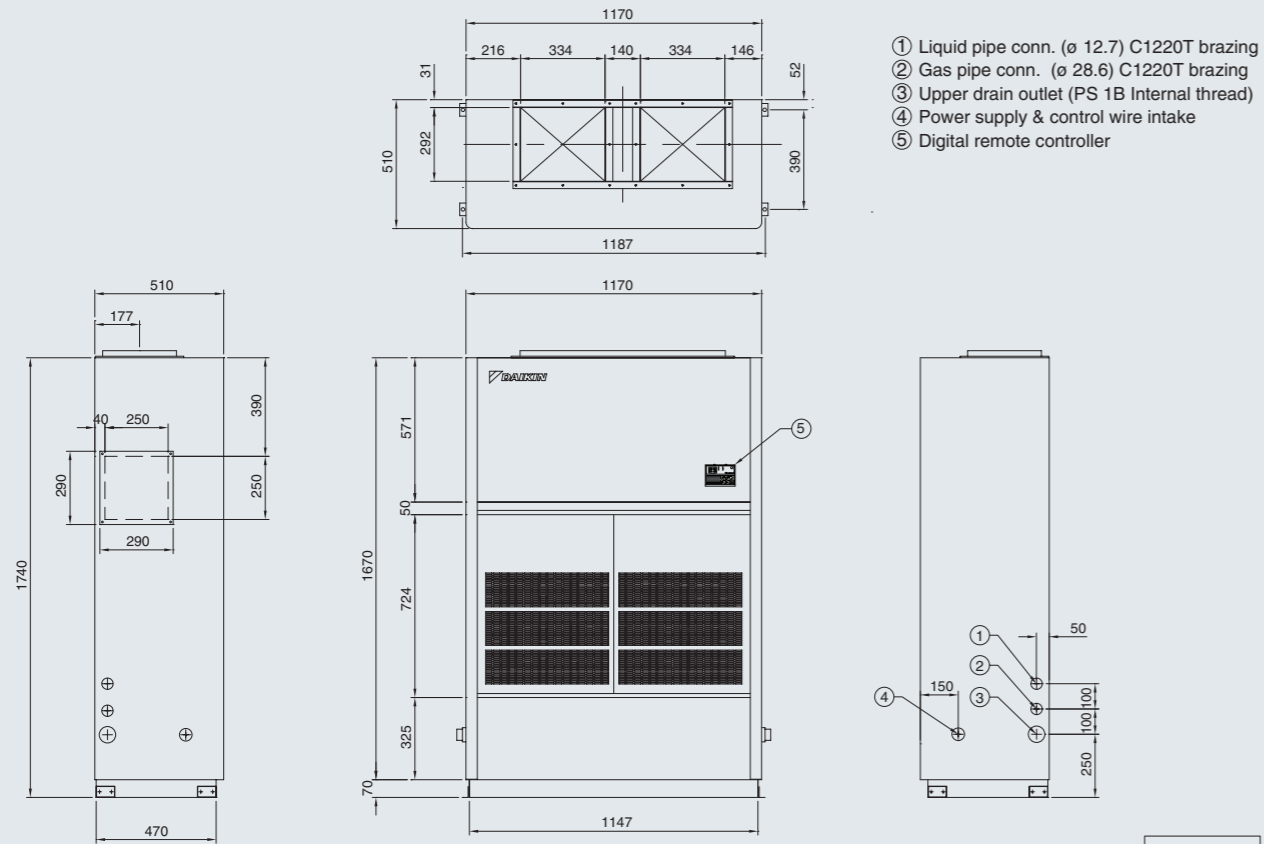

SDR3150176

## DUCT TYPE

### FDR05NY1G

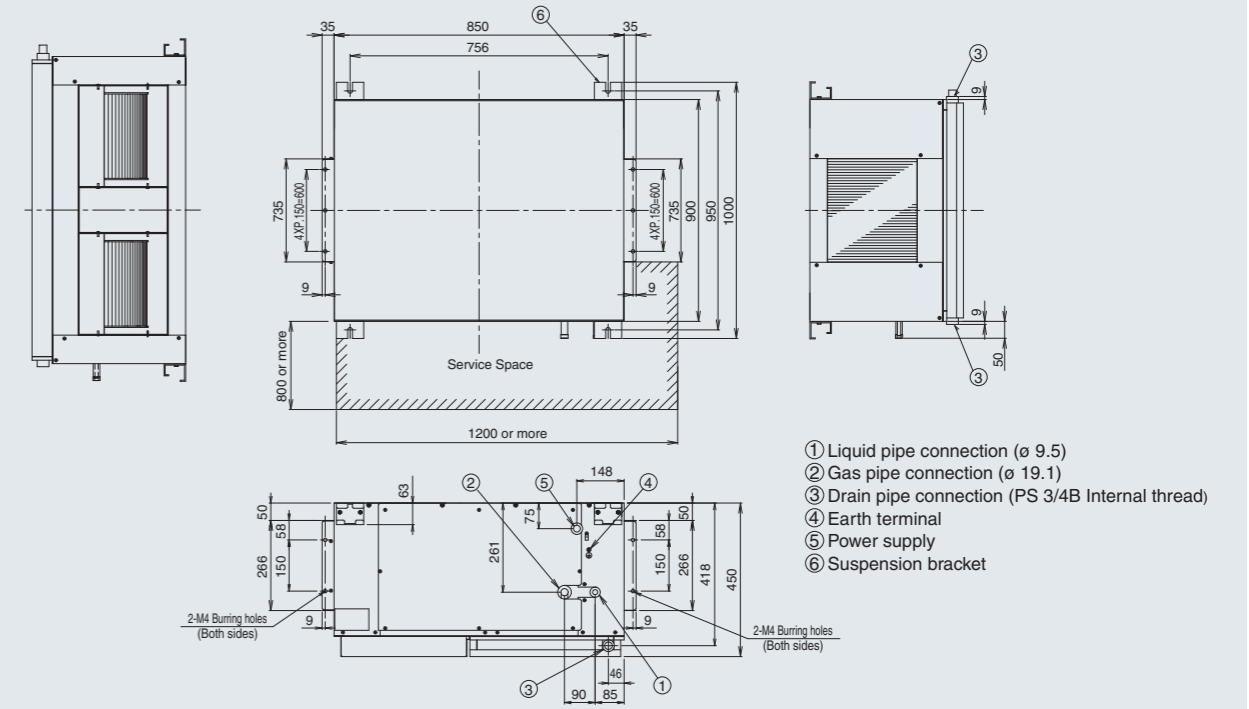

3D062899C

### FVPGR13NY1G

### FVPGR15NY1G

### FVPGR18NY1G

### FVPGR20NY1G

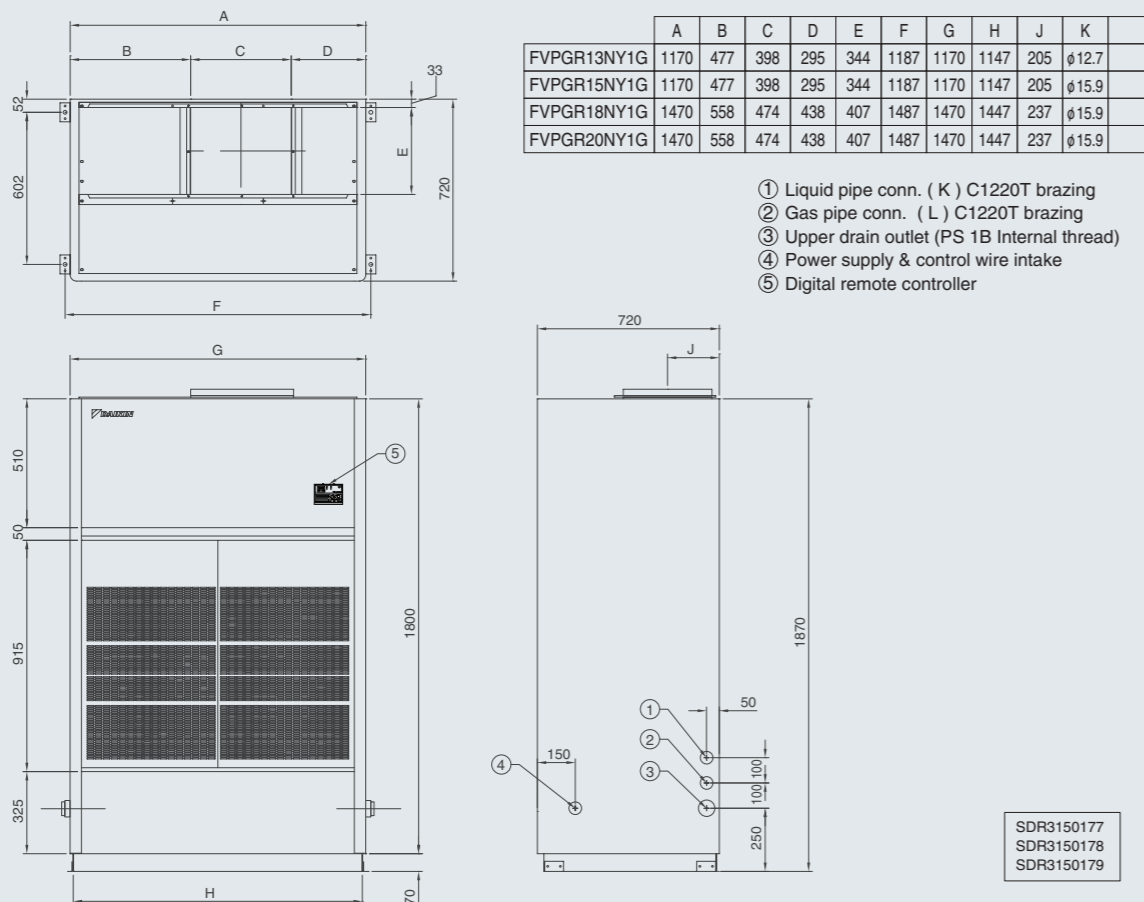

SDR3150177  
 SDR3150178  
 SDR3150179

### FDR06NY1G

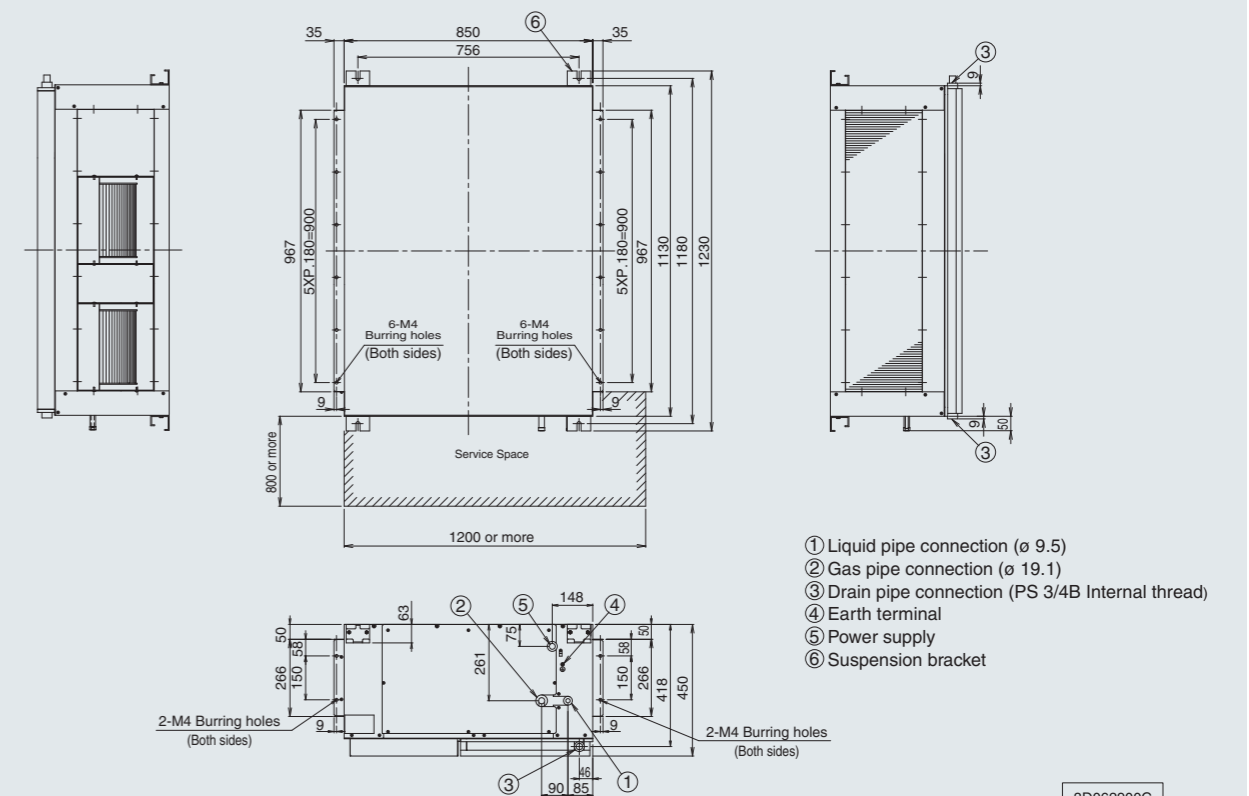

3D062900C

## OUTDOOR UNIT

### FDR08NY1G / 10NY1G

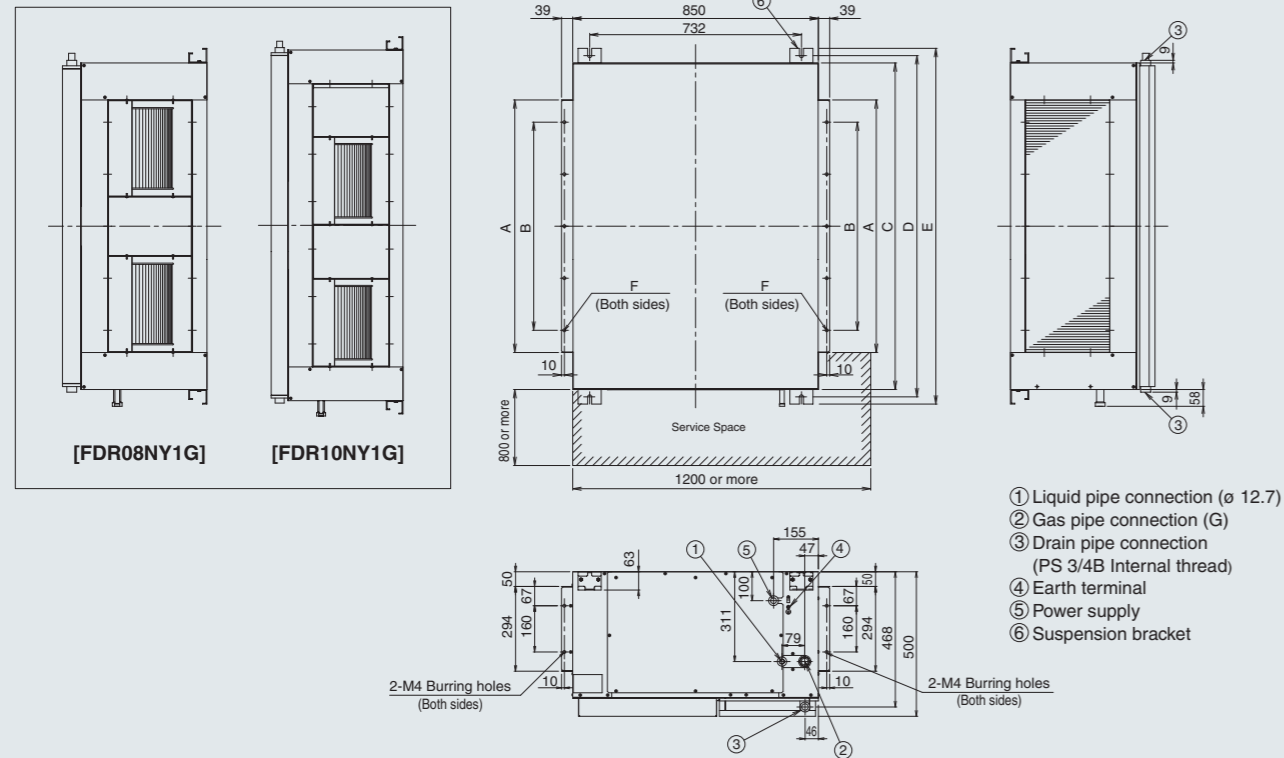

	A	B	C	D	E	F	G
FDR08NY1G	876	4XP.180=720	1130	1180	1230	5-M4 Burring holes	ø22.2
FDR10NY1G	1076	5XP.180=900	1330	1380	1430	6-M4 Burring holes	ø28.6

3D062901C  
3D062902C

### RUR05NY1 RUR06NY1

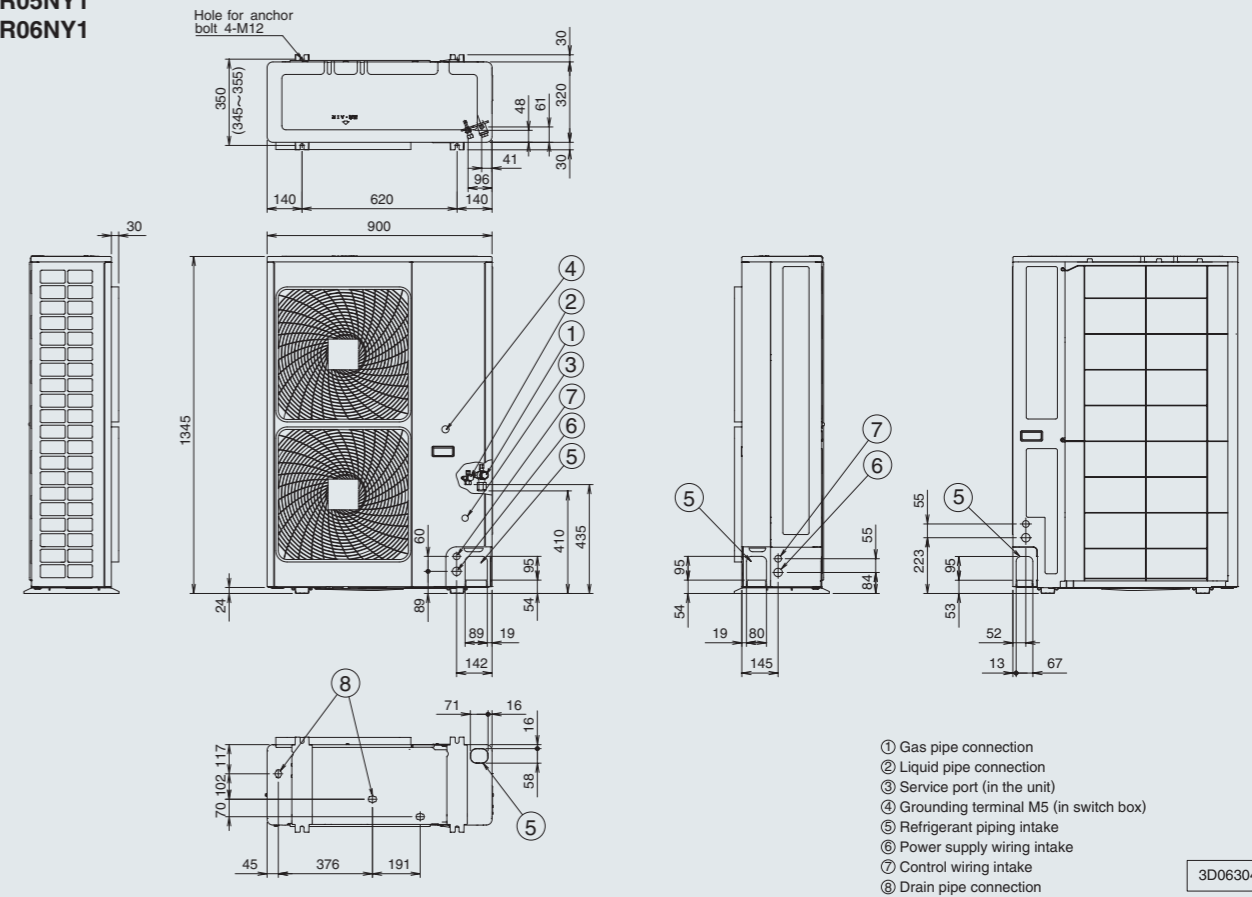

3D063042A

### FDR13NY1G / 15NY1G / 18NY1G / 20NY1G

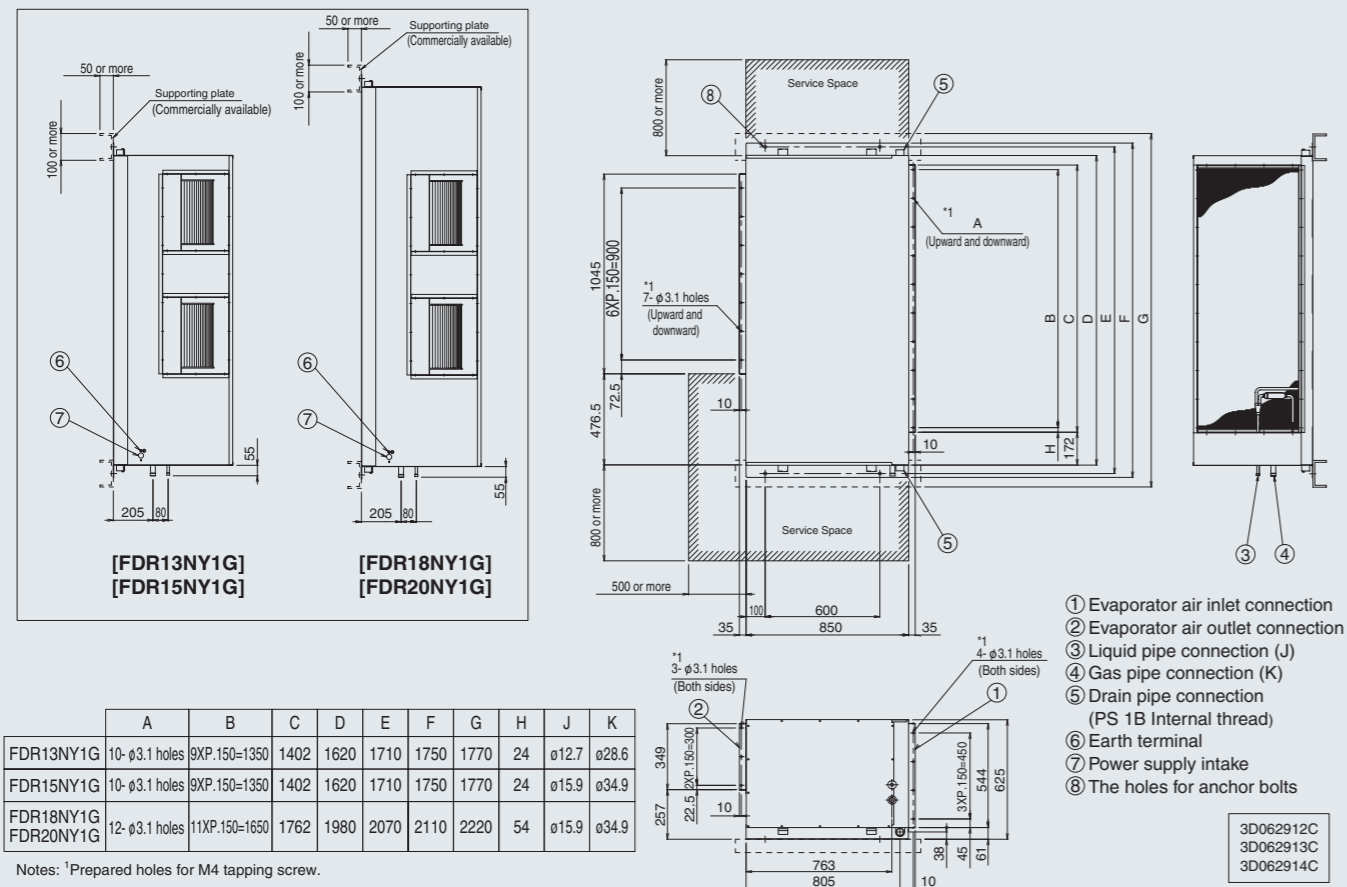

	A	B	C	D	E	F	G	H	J	K
FDR13NY1G	10-ø3.1 holes	9XP.150=1350	1402	1620	1710	1750	1770	24	ø12.7	ø28.6
FDR15NY1G	10-ø3.1 holes	9XP.150=1350	1402	1620	1710	1750	1770	24	ø15.9	ø34.9
FDR18NY1G	12-ø3.1 holes	11XP.150=1650	1762	1980	2070	2110	2220	54	ø15.9	ø34.9

Notes: 1 Prepared holes for M4 tapping screw.

3D062912C  
3D062913C  
3D062914C

### RUR08NY1 RUR10NY1

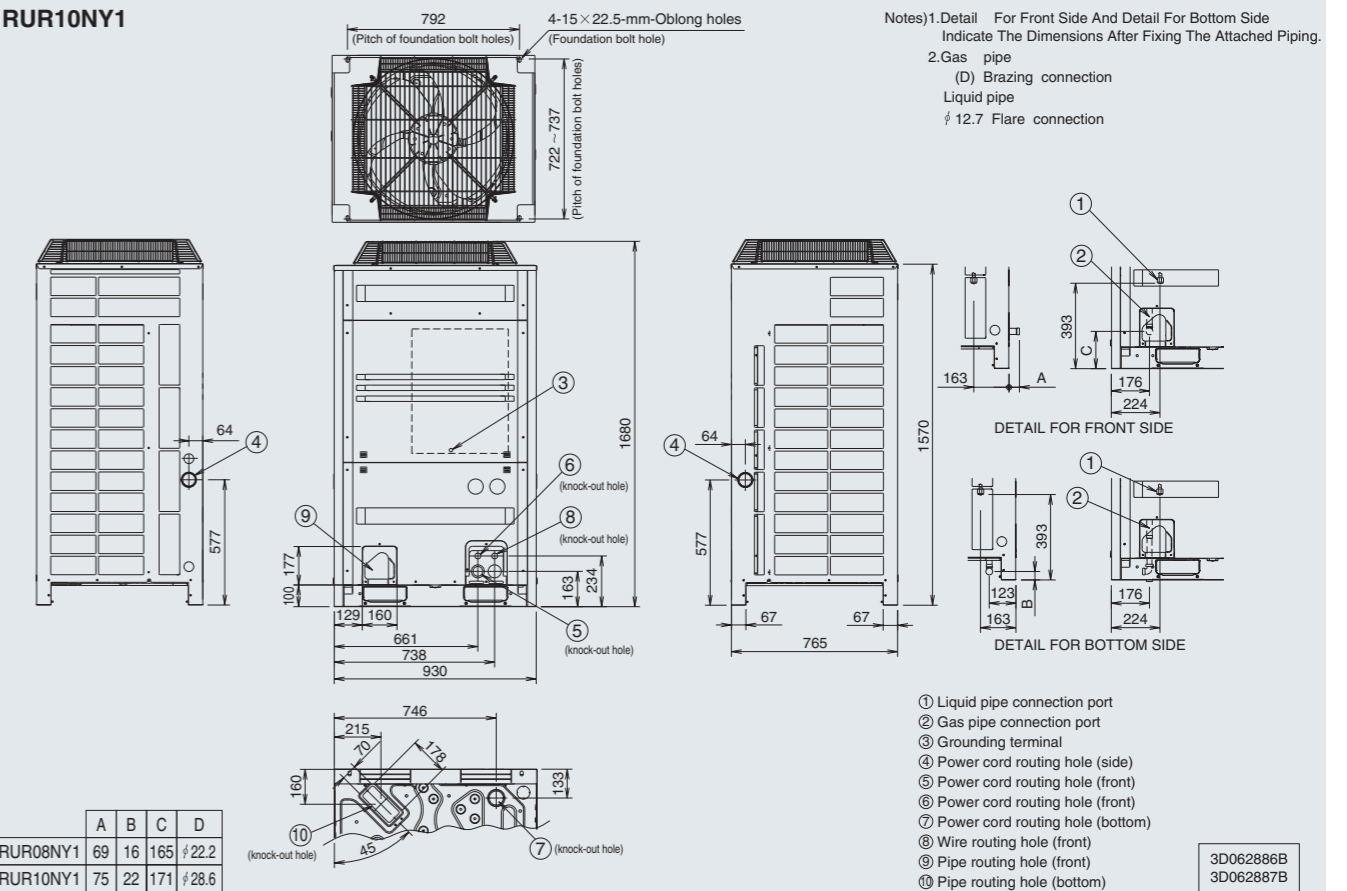

	A	B	C	D
RUR08NY1	69	16	165	ø22.2
RUR10NY1	75	22	171	ø28.6

3D062886B  
3D062887B



RUR13NY1  
RUR15NY1  
RUR18NY1  
RUR20NY1

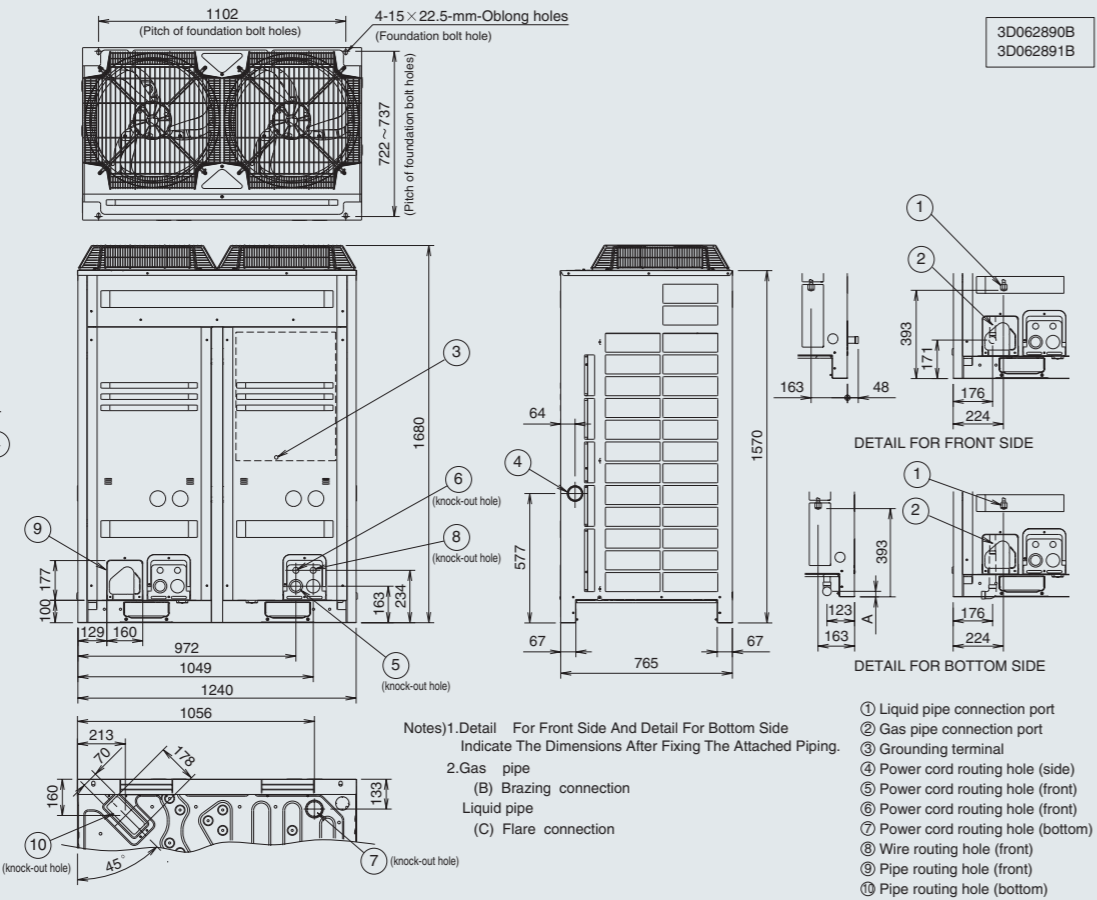

FVGR05NV1  
FVGR06NV1  
FVGR08NV1  
FVGR10NV1

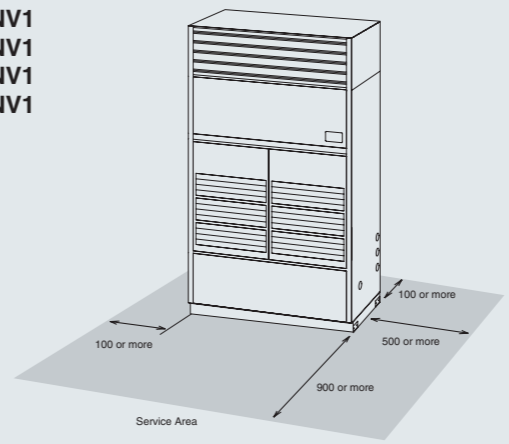

FVPGR10NY1G  
FVPGR13NY1G  
FVPGR15NY1G  
FVPGR18NY1G  
FVPGR20NY1G

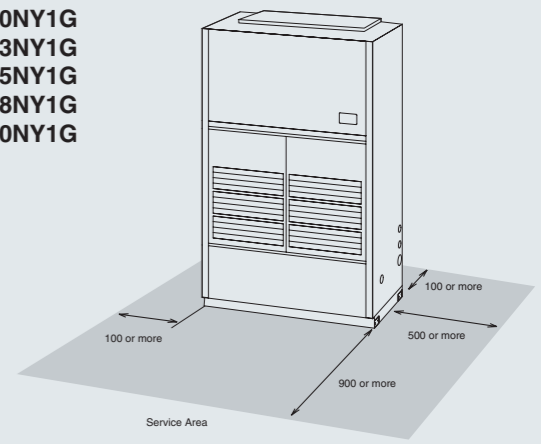

FDR05NY1G  
FDR06NY1G  
FDR08NY1G  
FDR10NY1G

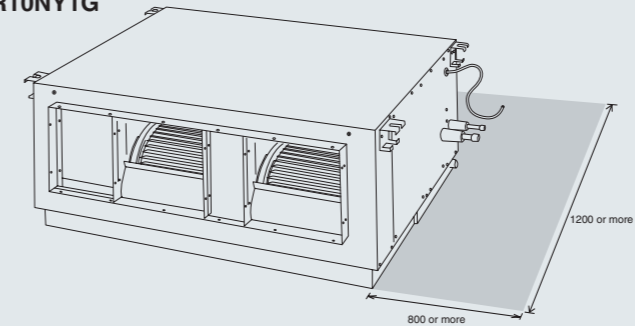

FDR13NY1G  
FDR15NY1G  
FDR18NY1G  
FDR20NY1G

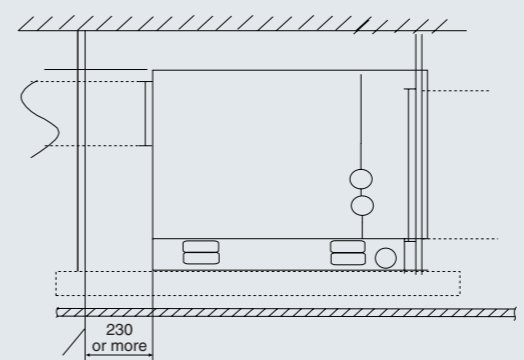
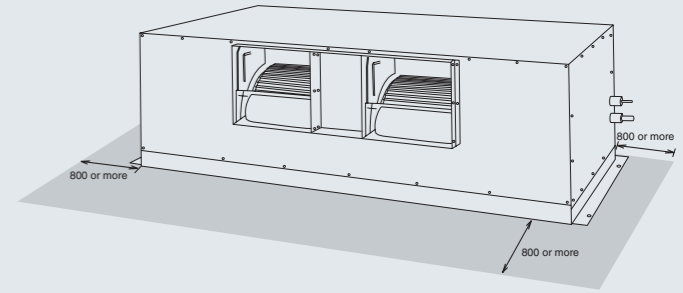

When installing the switch box, the suspension bolt should be 230 mm or more away from the unit (so that maintenance can easily be carried out the switch box).

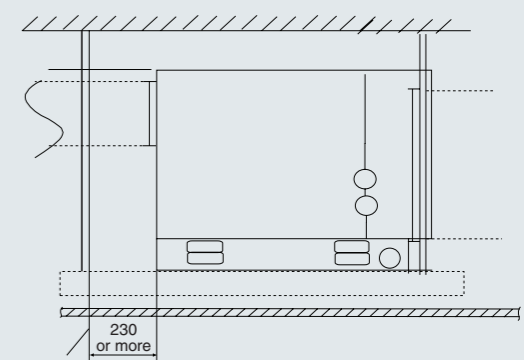

When installing the switch box, the suspension bolt should be 230 mm or more away from the unit (so that maintenance can easily be carried out the switch box).

Provide enough clearance between the unit and the surrounding walls to prevent contact.

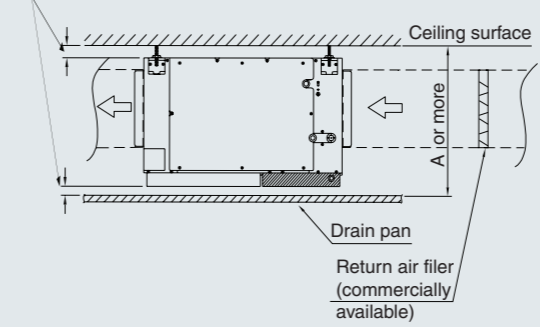

Provide enough clearance between the unit and the surrounding walls to prevent contact.

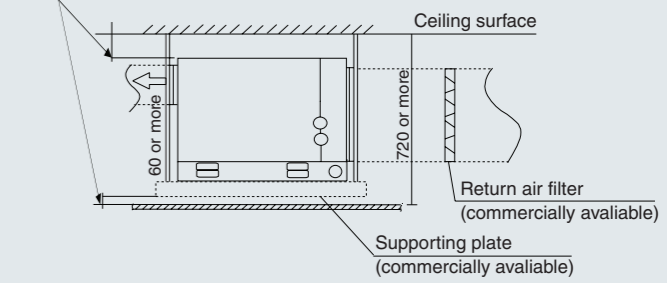

	Model	
	FDR05-06 type	FDR08-10 type
A	520	570

For RUR05NY1/06NY1

When there is an obstruction on the inlet side

When the overhead space is open

1. For single unit installation

When there is an obstruction only on the inlet side

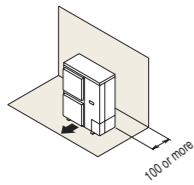

When there are obstructions on both sides

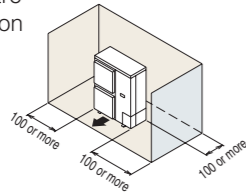

2. For series installation (more than two units)

When there are obstructions on both sides

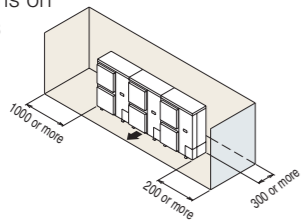

When there is an obstruction in the overhead space

1. For single unit installation

When there is an obstruction on the inlet side

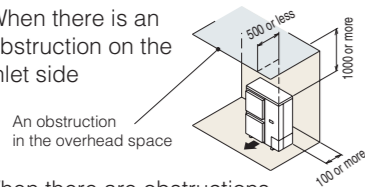

When there are obstructions on the inlet side and both lateral sides

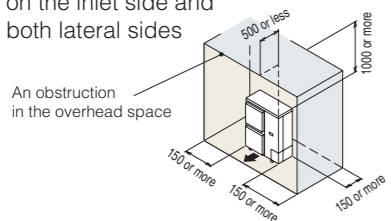

2. For series installation (more than two units)

When there are obstructions on the inlet side and both lateral sides

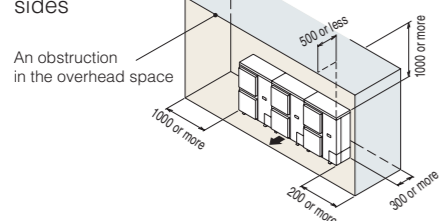

When there is an obstruction on the outlet side

When the overhead space is open

1. For single unit installation

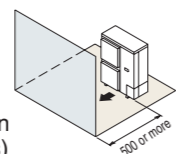

2. For series installation (more than two units)

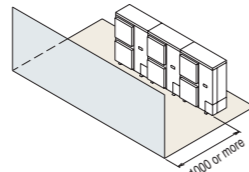

When there is an obstruction in the overhead space

1. For single unit installation

An obstruction in the overhead space

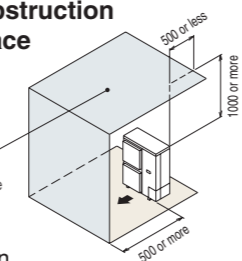

2. For series installation (more than two units)

An obstruction in the overhead space

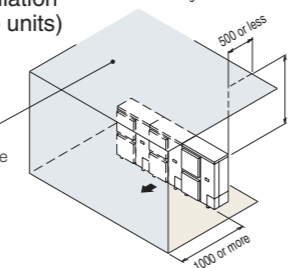

When there are obstructions on both the inlet and outlet sides

Pattern 1 For other patterns, please refer to engineering databook.

When the obstruction on the outlet side is higher than the unit itself (There is no limit to the height of the obstruction on the outlet side.)

When the overhead space is open

1. For single unit installation

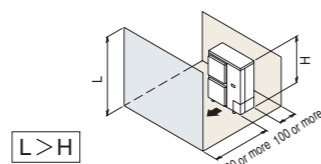

2. For series installation (more than two units)

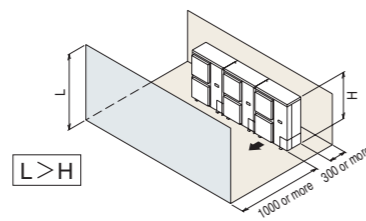

For RUR08NY1/10NY1/13NY1/15NY1/18NY1/20NY1

(Please refer to engineering databook for other installation patterns.)

For single unit installation

Pattern 1

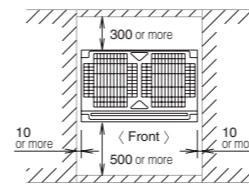

Pattern 2

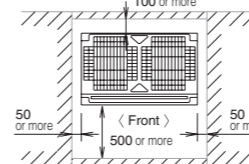

Pattern 3

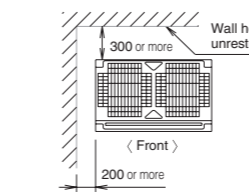

For installation in rows

Pattern 1

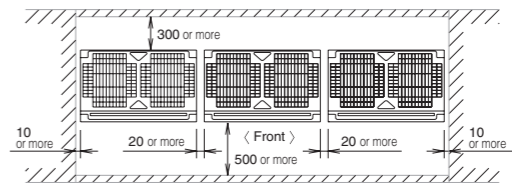

Pattern 2

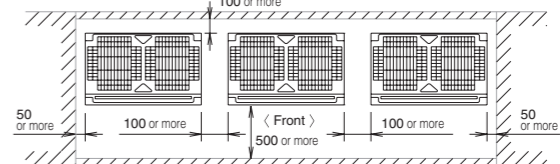

Pattern 3

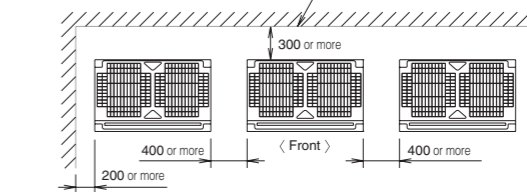

For centralized group layout

Pattern 1

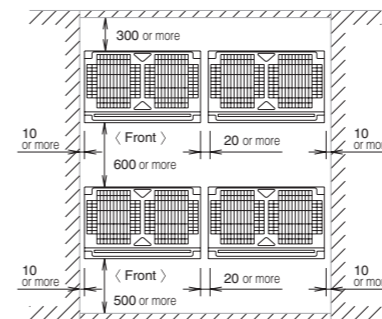

Pattern 2

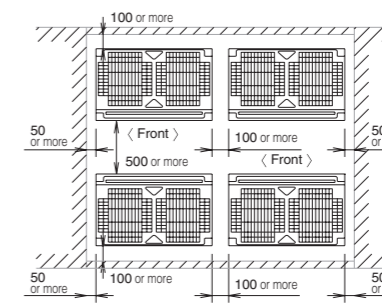
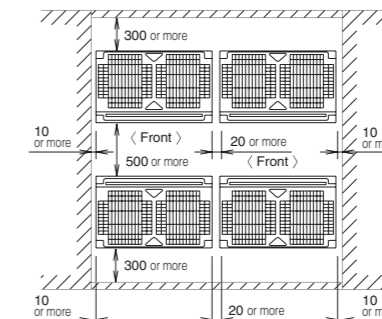
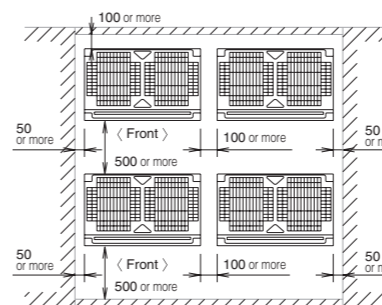

< Unit : mm >

Notes:

<sup>1</sup>Heights of walls in case of Patterns 1 and 2:

Front : 1500 mm

Suction side : 500 mm

Side : Height unrestricted.

Installation space to be shown in this drawing is based on the cooling operation at 35 degrees outdoor air temperature. When the design outdoor air temperature exceeds 35 degrees or the load exceeds maximum ability because of much generation load of heat in all outdoor unit, take the suction side space more broadly than the space to be shown in this drawing.

<sup>2</sup>If the above wall heights are exceeded then h2/2 and h1/2 should be added to the front and suction side service spaces respectively as shown in the figure on the right.

<sup>3</sup>When installing the units most appropriate pattern should be selected from those shown above in order to obtain the best fit in the space available always bearing in mind the need to leave enough space for a person to pass between units and wall and for the air to circulate freely.

( If more units are to be installed than are catered for in the above patterns ) your layout should take account of the possibility of short circuits.

<sup>4</sup>The units should be installed to leave sufficient space at the front for the on site refrigerant piping work to be carried out comfortably.

