



- Ask a qualified installer or contractor to install this product. Do not try to install the product by yourself. Improper installation can result in water or refrigerant leakage, electrical shock, fire or explosion.
- Use only those parts and accessories supplied or specified by Daikin. Ask a qualified installer or contractor to install those parts and accessories. Use of unauthorised parts and accessories or improper installation of parts and accessories can result in water or refrigerant leakage, electrical shock, fire or explosion.
- Read the user's manual carefully before using this product. The user's manual provides important safety instructions and warnings. Be sure to follow these instructions and warnings.

If you have any enquiries, please contact your local importer, distributor and/or retailer.

#### Cautions on product corrosion

1. Air conditioners should not be installed in areas where corrosive gases, such as acid gas or alkaline gas, are produced.
2. If the outdoor unit is to be installed close to the sea shore, direct exposure to the sea breeze should be avoided. If you need to install the outdoor unit close to the sea shore, contact your local distributor.

**Daikin Airconditioning (Singapore) PTE.LTD.**

10 Ang Mo Kio Industrial Park 2 Singapore 569501

Tel. +65-6538-8888

Fax. +65-6349-7310-11

● Specifications, designs and other content appearing in this brochure are current as of April 2017 but subject to change without notice.

All rights reserved 04/17



PCASSG1601A

Super Inverter

# SkyAir

## Air Conditioning System Cooling Only [50Hz]



Wide  
Line-up

Energy  
Saving





360°  
round flow

R-410A

# Product Lineup

● 1 phase ● 3 phase



Product	Series	50	60	71	100	125	140		
 CEILING MOUNTED CASSETTE TYPE <Round Flow>	Indoor unit	● FCQ50LUV1	● FCQ60LUV1	● FCQ71LUV1	<b>NEW</b> ● FCQ100KAVEA	<b>NEW</b> ● FCQ125KAVEA	<b>NEW</b> ● FCQ140KAVEA		
	Outdoor unit	RZR50LVVM	RZR60LVVM	RZR71LVVMG	<b>NEW</b> RZR100MVMG	<b>NEW</b> RZR100MYM	<b>NEW</b> RZR125MVMG	<b>NEW</b> RZR125MYM	<b>NEW</b> RZR140MYM
 DUCT CONNECTION MIDDLE and HIGH STATIC PRESSURE TYPE	Indoor unit	<b>NEW</b> ● FBQ50EVE	<b>NEW</b> ● FBQ60EVE	<b>NEW</b> ● FBQ71EVE	<b>NEW</b> ● FBQ100EVE	<b>NEW</b> ● FBQ125EVE	<b>NEW</b> ● FBQ140EVE		
	Outdoor unit	RZR50LVVM	RZR60LVVM	RZR71LVVMG	<b>NEW</b> RZR100MVMG	<b>NEW</b> RZR100MYM	<b>NEW</b> RZR125MVMG	<b>NEW</b> RZR125MYM	<b>NEW</b> RZR140MYM
 CEILING SUSPENDED TYPE	Indoor unit	● FHQ50BVV1G	● FHQ60BVV1G	● FHQ71BVV1B	● FHQ100BVV1B	<b>NEW</b> ● FHQ100DAVMA	● FHQ125BVV1B	<b>NEW</b> ● FHQ125DAVMA	<b>NEW</b> ● FHQ140DAVMA
	Outdoor unit	RZR50LVVM	RZR60LVVM	RZR71LVVM	RZR100LVVM	<b>NEW</b> RZR100MYM	RZR125LVVM	<b>NEW</b> RZR125MYM	<b>NEW</b> RZR140MYM
 WALL MOUNTED TYPE	Indoor unit			● FAQ71CVEA	● FAQ100CVEA				
	Outdoor unit			RZR71LVVM	RZR100LVVM	<b>NEW</b> RZR100MYM			
 FLOOR STANDING TYPE	Indoor unit	● FVQ50CVE	● FVQ60CVE	● FVQ71CVEB	● FVQ100CVEB	● FVQ125CVEB	● FVQ140CVEB		
	Outdoor unit	RZR50LVVM	RZR60LVVM	RZR71LVVM	RZR100LVVM	<b>NEW</b> RZR100MYM	RZR125LVVM	<b>NEW</b> RZR125MYM	<b>NEW</b> RZR140MYM

OUTDOOR UNIT	50	60	71	100	125	140	
 Outdoor unit			 	 	 	 	 

ENERGY SAVING LABEL	50	60	71	100	125	140
			 	 	 	

# Energy saving

Super Inverter



Throughout the cooling season, Daikin's new inverter models reduce energy consumption **NEW**

COP values by capacity for cassette models

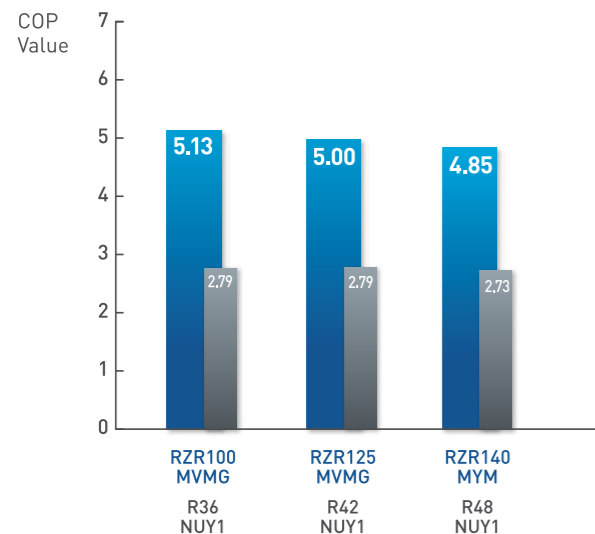

New inverter RZR-M series R410A (cassette type)

### What is COP?

COP is the value for the annual total cooling load divided by the annual total power consumption at outdoor air condition specified by ISO standard.

\* COP (coefficient of performance) is a new international energy-efficiency criterion calculated by methods stipulated in ISO 16358-1.

# Compact

New outdoor units save even more space **NEW**

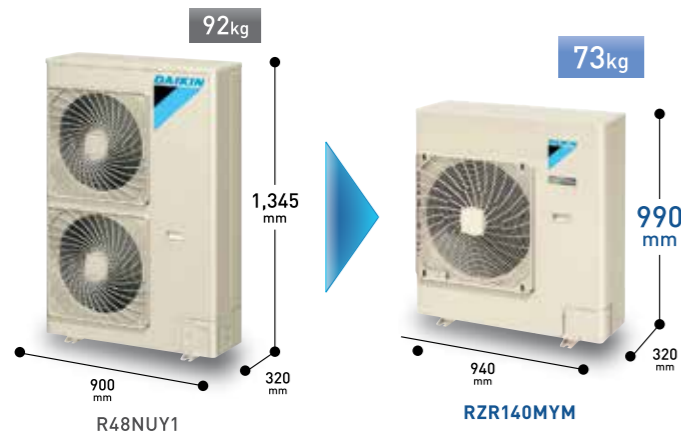

(In case of 14.0kW class)

Compared to the previous mainstream non-inverter series, outdoor units are much more compact. Easy installation in places with limited space.

10.0 kW	12.5 kW	14.0 kW
R36NUY1	R42NUY1	R48NUY1
79kg	87kg	92kg
1,170mm	1,170mm	1,345mm
900mm	900mm	900mm

RZR100MVMG	RZR125MVMG	RZR140MYM
New inverter RZR-M series		
990mm		65kg (VM) 73kg (VM)
940mm		

More compact, much higher COP!  
23% reduction in volume

# Comfort



Faster cooling and dehumidification: New inverter control technology brings quick comfort **NEW**

### Quick cooling start function

Quickly and easily make space comfortable before the arrival of office workers or shop customers. As well as quick cooling at max. capacity, new inverter control rapidly removes indoor humidity. More than simple temperature reduction, this twin reduction provides greater comfort (within 30 minutes max.).

→ New Inverter (RZR-M series)  
→ Usual Inverter (RZR-L series)  
→ Non inverter

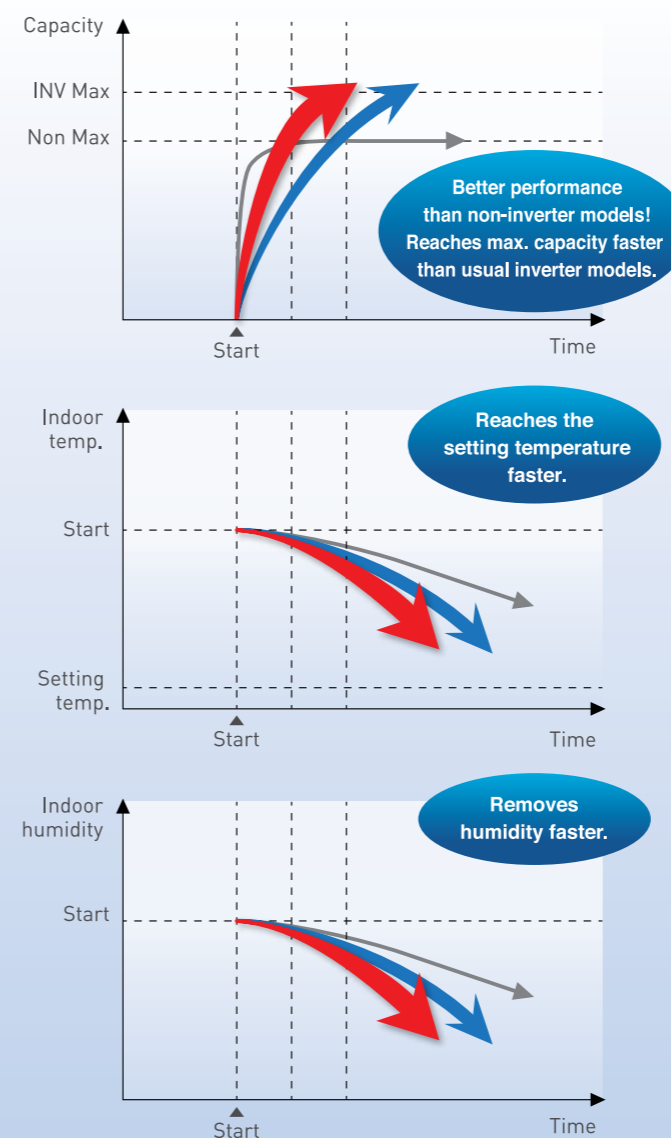

● BRC1E62 wired remote controller is used for 'Quick cooling start'.



OPTIONAL



# Durability

## Automatic protection against low voltage

In AM and PM peak electricity consumption periods, supply may fluctuate. Built-in low-voltage protection will automatically cut operations. When normal voltage is restored, operation will resume as before.

## Outdoor unit installation is possible even with limited space

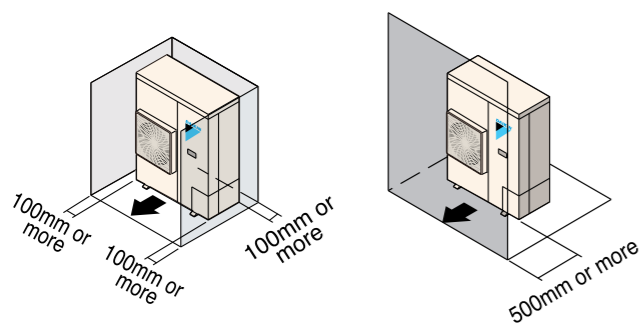

## Coated printed circuit boards

Coated circuit boards prevent problems caused by humidity and airborne dust.



## Self-diagnosis functions enable prompt maintenance response

An error message appears on the LCD of the remote controller and an LED lights up on the unit. When the BRC1E62 is installed, the error code appears showing contact information and model name. Contact your Daikin dealer and provide the error code and model name.



# Convenient functions

Super Inverter

And more... Advanced Daikin inverter technology brings various benefits to owners and installers.

## Navigation remote controller BRC1E62 includes various convenient functions

### Automatic return to temperature preset by owner.

#### Setpoint auto reset

- Even if the set temperature is changed, after a preset period new set temperature returns to preset value.
- Period selectable from 30, 60, 90, or 120 minutes.

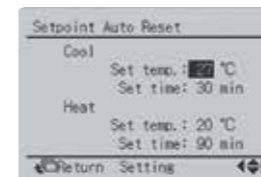

### Owner can preset upper and lower temperatures.

#### Setpoint range set

- Saves energy by limiting the min. and max. set temperature.
- Avoids excessive heating or cooling.
- This function is convenient if the remote controller is installed where anyone can change the settings.

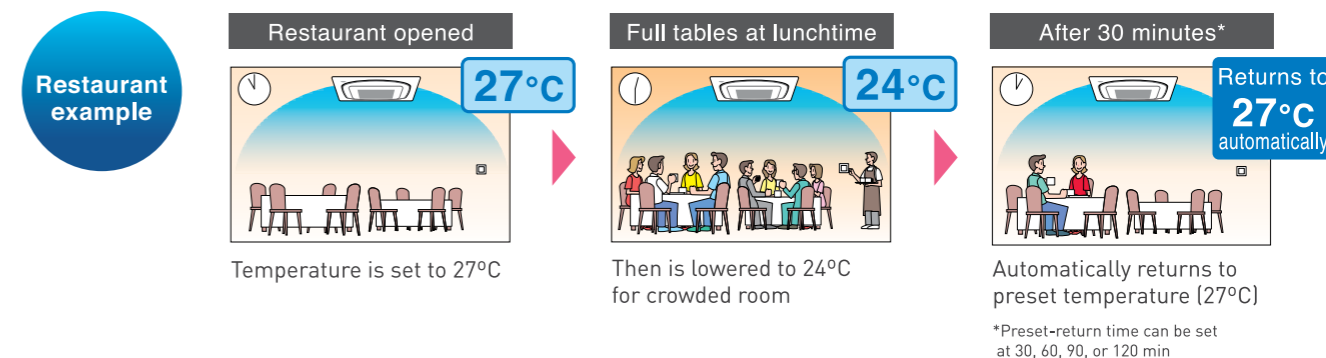
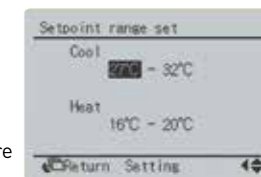

## Demand Control Function

By setting limits that restrict power consumption, you can cut electricity bills.

Power consumption is given first priority, and limits maximum power consumption of unit. Maximum power consumption can be set at 40, 60, 70, 80, or 100%.

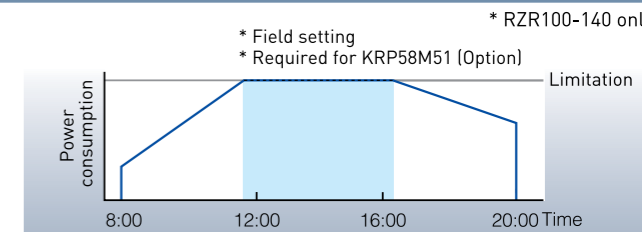

# More economy or comfort in special situations

\*Please refer to Service Manual.

## High sensible cooling enables even greater power savings



In locations such as simple server rooms, dehumidification is not required and greater power savings are possible with 'High sensible cooling' mode.

\*Field setting with remote controller.

## High dehumidification cooling provides even greater comfort



In restaurants and other spaces where many people gather, 'High dehumidification cooling' mode reduces humidity and creates greater comfort.

\*Available with RZR100-140M models. Field setting on outdoor unit.

## Night quiet operation mode

### Consideration for people living nearby

Outdoor unit operating sound can be reduced by 4dB(A).

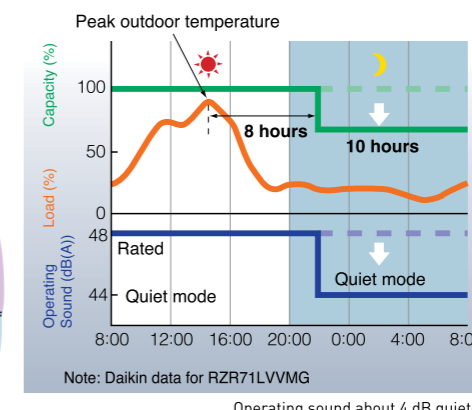
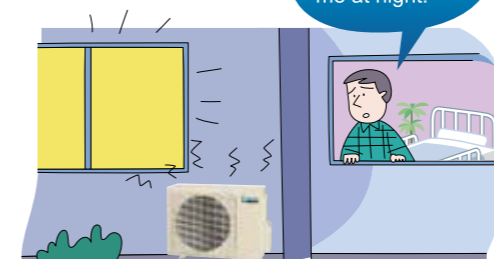

\*Field setting with remote controller



# Reuse of existing piping

(RZR-M series only.)

## Benefit 1 Simplified installation reduces replacement time and cost

When considering air conditioner replacement, do the following things concern you?

- For how long will the business have to close down? While replacement work is going on, how will sales be affected?
- Won't the costs be high and work period longer because scaffolding is necessary for pipe replacement?

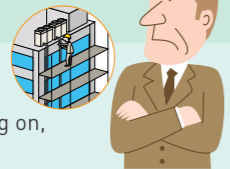

These problems are solved by Daikin!

Where feasible, by reusing existing pipes\*, we cut your work cost and reduce work time.



\*Strict conditions apply, please check the table on page 52 for acceptable pipe sizing (if pipes are to be reused).

## Benefit 2 You can increase cooling capacity and achieve higher energy efficiency

Upgrade to an air conditioner with the latest technology for greater comfort and energy efficiency.

R22 Non inverter  
7.6 kW class

φ9.5 φ15.9

FHC26NUV1  
R26NUV1

R410A inverter  
14.0 kW class

φ9.5 φ15.9

Pipes used as they are!

FCQ140KAVEA  
RZR140MYM

As a result, the greater capacity units ensure better performance to cope with the increasing amount of heat generated by office equipment and occupants.

## Technology

Advanced technology including the use of corrosion resistant electronic expansion valves, acid neutralisers and improved compressor reliability enables the re-use of existing piping\* without the need of pipe flushing for a simplified replacement process.

<p><b>Stronger refrigerating machine oil</b></p> <p>An acid neutraliser agent is added to disable acids (chlorine ions), which cause corrosion.</p> <p>Acid neutraliser</p> <p>Acid (chlorine ion)</p> <p>Refrigerant pipe</p>	<p><b>Highly corrosion resistant electronic expansion valve</b></p>	<p><b>Highly reliable compressor</b></p> <p>Compressor durability is improved by installing a filter or accumulator to collect solid foreign substances.</p> <p>Filter or accumulator</p> <p>Compressor</p>
--	---	---

\*Strict conditions apply, please check the table on page 52 for acceptable pipe sizing (if pipes are to be reused).

# Design flexibility

Super Inverter

## Possible to force On-Off operation using external command

(Available in duct connection middle static pressure type and wall mounted type)

\*Field setting with remote controller

Off-operation never overlooked if linked to use of hotel keycard: enables overall power savings.

Duct connection middle static pressure type  
FBQ-E series

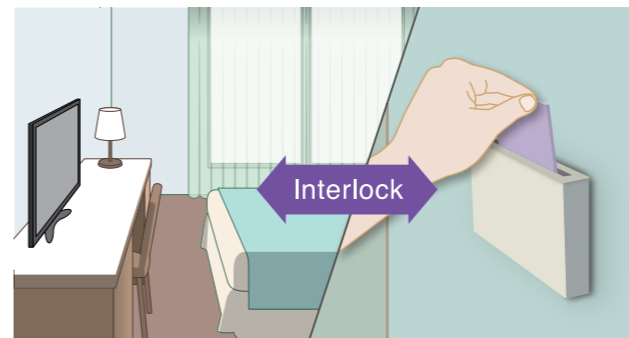

Wall mounted type  
FAQ-C series

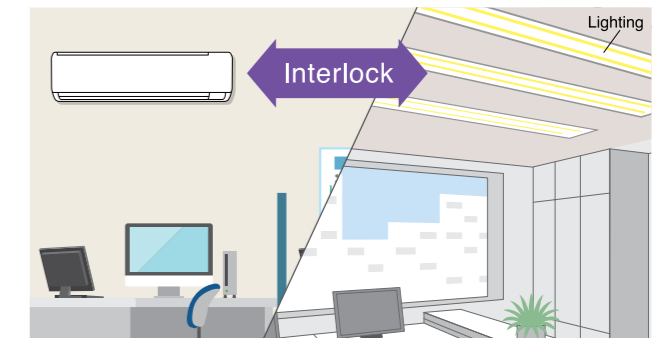

\*Other type of indoor unit is available by using optional adaptor.

## All indoor units comply with DIII-Net standards (connected to RZR series units)

**Previous indoor unit**

FHQ-BV

Optional interface adaptor is required

**New indoor unit**

FHQ-DA

Adaptor not required

Thanks to easy connection to DIII-NET and long piping length, suitable for projects that include VRV and SkyAir.

# Cassette Air Conditioner with 360° Uniform Airflow sets The Standard

FCQ50/60/71LUV1  
FCQ100/125/140KAVEA

**ROUND FLOW**



## Comfort Enhanced by Round Flow!

- 360° airflow  
With uniform temperature distribution
- Air movement is gentle with Round Flow  
Enhanced Comfort



If you raise the set temperature by 1 to 1.5°C, and velocity is decreased by 25%, you still obtain the same feeling temperature and comfort.

## Adapts Easily to The Installation Space.

Because air flows out from corner outlets, comfort spreads more widely.

### Typical flow patterns

There are a total of 23 flow patterns.

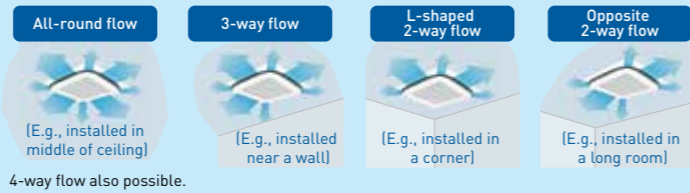

Note: Whatever the discharge direction, the same type of panel is used. If installing for other than all-round flow, an air discharge outlet sealing material (option) must be used to close each unused outlet. Operation sound increases when using 2-way or 3-way flow.

## Optimal Comfort and Convenience Assured by 2 Air Discharge Modes

Air direction	Standard setting <sup>1</sup>	Setting to prevent soiling of ceiling <sup>2</sup> (field setting)
Desired situation	Standard position to prevent draft.	Recommended for shops with light coloured ceilings that must be kept spotless.
Auto-swing	Auto-swing between 15° and 60°	Auto-swing between 25° and 60°
5-levels air direction setting	Settable to 5 different levels between 15° and 60°	Settable to 5 different levels between 25° and 60°
Auto air direction control	The air direction is set automatically to the memorised position of the previous air direction.	

Note:  
1 Air direction is set to the standard position when the unit is shipped from the factory. The position can be changed from the remote controller.  
2 Closing of the corner discharge outlets is recommended.

## Compact Body for Quick & Easy Installation in Tight Ceiling (50LU-71LU)

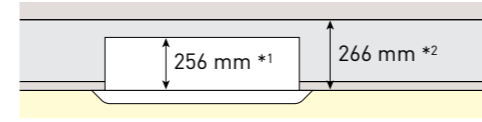

\*1 298 mm high with 100-140 KA/LU  
\*2 308 mm high with 100-140 KA/LU

## Drain Pump is Equipped as Standard Accessory with 850 mm Lift.

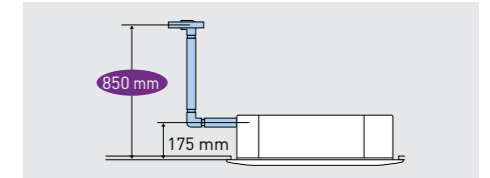

## Easy Maintenance

- The condition of the drain pan and drain water can be checked by removing the drain plug and suction grille.

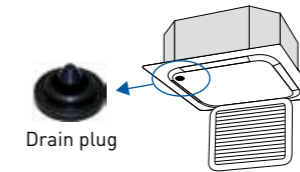

Just open the suction grille!

- With Ultra long-life filters (option), maintenance is not required in normal shops or offices for up to four years.

## SPECIFICATIONS

		50	60	71	100	125	100	125	140	
Model Name	Indoor unit	FCQ50LUV1	FCQ60LUV1	FCQ71LUV1	FCQ100KAVEA	FCQ125KAVEA	FCQ100KAVEA	FCQ125KAVEA	FCQ140KAVEA	
	Outdoor unit	RZR50LVM	RZR60LVM	RZR71LVMG	RZR100MVMG	RZR125MVMG	RZR100MYM	RZR125MYM	RZR140MYM	
Power supply	Outdoor unit	1 Phase, 220-240 V, 50 Hz					3 Phase, 380-415 V, 50 Hz			
Cooling capacity <sup>1,2</sup> Rated (Min. - Max.)	kW	5.0 (2.3-5.6)	6.0 (2.6-6.3)	7.1 (3.2-8.0)	9.5 (4.5-11.2)	10.8 (5.4-14.0)	10.0 (5.0-11.2)	12.5 (5.7-14.0)	14.0 (6.2-15.4)	
	Btu/h	17,100 (7,900-19,100)	20,500 (8,900-21,500)	24,200 (10,900-27,300)	32,400 (15,400-38,200)	36,900 (18,400-47,800)	34,100 (17,100-38,200)	42,700 (19,500-47,800)	47,800 (21,200-52,600)	
Power consumption	Cooling <sup>1</sup>	kW	1.03	1.40	1.80	2.51	3.22	2.78	4.31	
	W/W		4.85	4.29	3.78	3.79	3.35	3.60	2.90	
COP										
Indoor unit	Colour	Decoration panel		Fresh white						
	Airflow rate (H/M/L)	m <sup>3</sup> /min		21/-/13.5		32/26/20		33/28/22.5		
	Sound level (HH/H/M/L) <sup>3</sup>	dB(A)		[-/35/-/28]		(43/37.5/-/32)		(44/39/-/34)		
	Dimensions (HxWxD)	Unit	mm		256x840x840		50x950x950		298x840x840	
		Decoration panel	mm							
	Machine weight	Unit	kg		21		24			
Certified Operation range	Decoration panel	kg				5.5				
	Cooling	°CWB		14 to 25						
Outdoor unit	Colour	Ivory white		Hermetically sealed swing type						
	Compressor	Type	Hermetically sealed swing type		2.03		2.03		1.92	
		Motor output	kW		1.12		1.35		1.76	
	Refrigerant charge (R-410A)	kg	1.6		1.9		1.9		1.9	
		(Charged for 30 m)	(Charged for 30 m)		(Charged for 30 m)		(Charged for 30 m)		(Charged for 30 m)	
	Sound level <sup>3</sup>	Cooling	dB(A)		48		49		52	
Night quiet mode		dB(A)		44		45		45		
Dimensions (HxWxD)	mm	595x845x300		990x940x320		990x940x320		990x940x320		
	Machine weight	kg		43		65		73		
Certified Operation range	Cooling	°CDB		21 to 46						
		mm		φ 9.5						
Piping connections	Liquid (Flare)	mm		φ 9.5						
	Gas (Flare)	mm		φ 15.9						
Drain	Indoor unit	mm		VP25 (I.D.φ 25x0.Dφ 32)						
	Outdoor unit	mm		φ 26.0 (Hole)						
Max. interunit piping length	m	50 (Equivalent length 70)								
Max. installation level difference	m	30								
Heat insulation		Both liquid and gas piping								

Note: <sup>1</sup>Rated cooling capacities are based on the following conditions: Suction temp., 27°CDB, 19.0°CWB; outdoor temp. 35°CDB, 24°CWB. Equiv. refrigeration piping, 7.5 m (horizontal)  
<sup>2</sup>Capacities are net, including a deduction for cooling for indoor fan motor heat.  
<sup>3</sup>Anechoic chamber conversion value, measured according to JIS parameters and criteria. During operation these values are somewhat higher owing to ambient conditions.

## OPTIONS

Name of option	Remark	Kit name	
		FCQ50/60/71LUV1	FCQ100/125/140KAVEA
Decoration panel		BYCP125K-W1	
Sealing material of air discharge outlet		KDBH55K160F	
Panel spacer		KDBP55H160FA	
Fresh air intake kit	Chamber type	Without T-joint pipe and fan	
	Direct installation type	With T-joint pipe, without fan	
Filter chamber		KDDP55B160	
	Replacement long-life filter	KDDP55B160K	
Ultra long-life filter unit (including filter chamber)		KDDP55X160	
	Replacement ultra long-life filter	KDDFP55B160	
Chamber connection kit <sup>1</sup>		KAFP551K160	
Remote controller	Wireless type	BRC7F633F	
	Wired type <sup>2</sup>	BRC1C61	
Navigation Remote Controller	Wired type <sup>2</sup>	BRC1E62	
Wiring adaptor for electrical appendices [2] <sup>3</sup>		KRP4AA53	
Installation box for adaptor PCB		KRP1H98	

Note: <sup>1</sup>Required for installing high-efficiency filter unit and ultra long-life filter unit.  
<sup>2</sup>Wiring for wired remote controller to be procured locally.  
<sup>3</sup>Installation box for adaptor PCB (KRP1H98) is necessary.

## Quiet Operation at 28\*\* dB(A)

\*\*Selected models only

Note : Anechoic chamber conversion value, measured according to JIS parameters and criteria. During operation these values are some what higher owing to ambient conditions.

## Easy Cleaning with Coated External Panels.

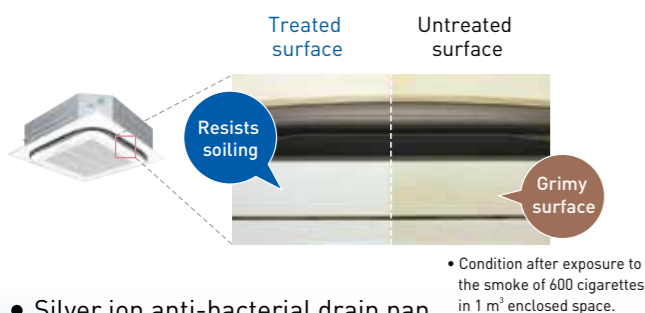

- Silver ion anti-bacterial drain pan
- Non-flocking flaps
- Filter has anti-mould and antibacterial treatment

# Thinner Design Allows Greater Installation Flexibility



FBQ50/60/71/100/125/140EVE



## Design and Installation Flexibility

With a height of only 245 mm, installation is possible even in buildings with narrow ceiling spaces



One of the industry's most compact bodies in the mid-static pressure range.

Indoor unit	71E	100/125/140E
Height (mm)	245	
Width (mm)	1,000	1,400
Depth (mm)	800	

Higher lift is realized by utilising built-in DC drain pump with standard accessory

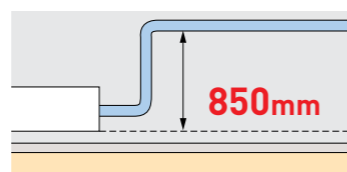

## High Efficiency

DC Fan motor and DC drain pump are utilised to improve energy efficiency

## Clean

Silver ion anti-bacterial drain pan  
A built-in antibacterial treatment that uses silver ion in the drain pan prevents the growth of slime, bacteria, and mould that cause smells and clogging.

Using a DC fan motor, the external static pressure can be controlled to within a range of 50 Pa to 150 Pa

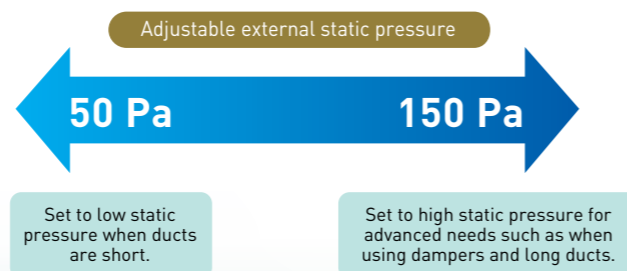

Comfort airflow is achieved in accordance with conditions such as duct length.

## Easy Maintenance

Position of drain pan inspection opening has been modified for easier inspection work

### Drain pan maintenance check window

This makes it possible to inspect for drain pan dirt and to confirm drainage during installation without the use of tools.

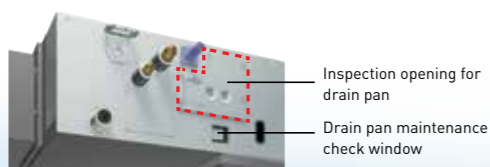

Easy maintenance because the drain pan can be removed

## Airflow rate auto adjustment function

Controls the airflow rate using a remote controller during test run. It is automatically adjusted to approximately ±10% of the rated H tap airflow.

## Interlock control by outside system

Enables control by hotel key card system acting as master ON/OFF for room electricity.

Enables central control of room ventilation and lighting by third-party building management system.

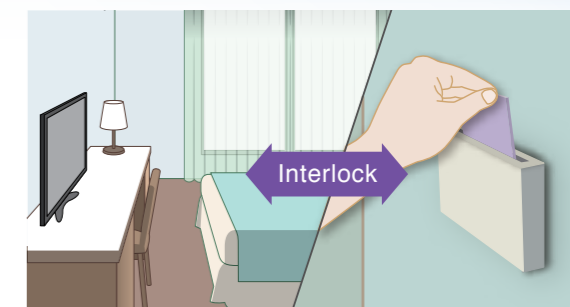

## SPECIFICATIONS

		50	60	71	100	125
Model Name	Indoor unit	FBQ50EVE	FBQ60EVE	FBQ71EVE	FBQ100EVE	FBQ125EVE
	Outdoor unit	RZR50LVVM	RZR60LVVM	RZR71LVVMG	RZR100MVMG	RZR125MVMG
Power supply		1 Phase, 220-240 V, 50 Hz				
Cooling capacity <sup>1,2</sup> Rated (Min. - Max.)		5.0 (2.3-5.6)	6.0 (2.6-6.3)	7.1 (3.2-8.0)	9.5 (4.5-11.2)	10.8 (5.4-14.0)
		17,100 (7,900-19,100)	20,500 (8,900-21,500)	24,200 (10,900-27,300)	32,400 (15,400-38,200)	36,900 (18,400-47,800)
Power consumption	Cooling <sup>1</sup>	1.39	1.69	2.22	2.51	3.22
	W/W	3.60	3.56	3.20	3.79	3.35
Indoor unit	Fan	Airflow rate (H/M/L)		m <sup>3</sup> /min		18/15/12.5
		External static pressure <sup>3</sup>		Pa		Rated 50 (50-150)
		Sound pressure level (H/M/L) <sup>4</sup>		dB(A)		35/33/31
		Dimensions (HxWxD)		mm		245x1,000x800
		Machine weight (indoor)		kg		245x1,400x800
Outdoor unit	Sound pressure level <sup>4</sup>	Cooling	dB(A)		48	49
		Night quiet mode	dB(A)		44	45
	Dimensions (HxWxD)		mm		595x845x300	990x940x320
	Machine weight (outdoor)		kg		43	65
	Piping connection		Liquid		mm	
		Gas		mm		φ 15.9 (Flare)
		Drain		mm		VP25 (I.D.φ 25x0.D.φ 32)
		Indoor unit		mm		φ 26 (Hole)
		Outdoor unit		mm		
Max interunit piping length		mm		mm		50 (Equivalent length 70m)
Heat insulation						Both liquid and gas piping

		100	125	140		
Model Name	Indoor unit	FBQ100EVE	FBQ125EVE	FBQ140EVE		
	Outdoor unit	RZR100MYM	RZR125MYM	RZR140MYM		
Power supply		1 Phase, 220-240 V, 50 Hz				
		3 Phase, 380-415 V, 50 Hz				
Cooling capacity <sup>1,2</sup> Rated (Min. - Max.)		10.0 (5.0-11.2)	12.5 (5.7-14.0)	14.0 (6.2-15.4)		
		34,100 (17,100-28,200)	42,700 (19,500-47,800)	47,800 (21,200-52,600)		
Power consumption	Cooling <sup>1</sup>	2.82	4.58	5.85		
	W/W	3.55	2.73	2.39		
Indoor unit	Fan	Airflow rate (H/M/L)		m <sup>3</sup> /min		38/35.5/33
		External static pressure <sup>3</sup>		Pa		Rated 50 (50-150)
		Sound pressure level (H/M/L) <sup>4</sup>		dB(A)		40/37.5/35
		Dimensions (HxWxD)		mm		245x1,400x800
		Machine weight (indoor)		kg		47
Outdoor unit	Sound pressure level <sup>4</sup>	Cooling	dB(A)		49	52
		Night quiet mode	dB(A)		45	45
	Dimensions (HxWxD)		mm		990x940x320	
	Machine weight (outdoor)		kg		73	54
	Piping connection		Liquid		mm	
		Gas		mm		φ 15.9 (Flare)
		Drain		mm		VP25 (I.D.φ 25x0.D.φ 32)
		Indoor unit		mm		φ 26 (Hole)
		Outdoor unit		mm		
Max interunit piping length		m		m		50 (Equivalent length 70m)
Heat insulation						Both liquid and gas piping

Note: <sup>1</sup>Rated cooling capacities are based on the following conditions: Indoor temp., 27°CDB, 19.0°CWB; outdoor temp. 35°CDB, 24°CWB. Equip. refrigeration piping, 7.5 m (horizontal)  
<sup>2</sup>Capacities are net, including a deduction for cooling for indoor fan motor heat.  
<sup>3</sup>External static pressure is changeable in 11 stages by remote controller.  
<sup>4</sup>Anechoic chamber conversion value, measured according to JIS parameters and criteria. During operation these values are somewhat higher owing to ambient conditions.  
<sup>5</sup>Air filter is not standard accessory, but please mount it in the dust system of the suction side. Select its duct collection efficiency/gravity method/50% or more.

## OPTIONS

Name of option	Remark	Kit name					
		FBQ50EVE	FBQ60EVE	FBQ71EVE	FBQ100EVE	FBQ125EVE	FBQ140EVE
Remote controller	Wireless type	BRC4C66					
	Wired type <sup>1</sup>	BRC1C61					
Navigation Remote Controller <sup>1</sup>		BRC1E62					
Adaptor for wiring		KRP1C64 *					
Wiring adaptor for electrical appendices(2)		KRP4AA51 *					
Remote sensor		KRC501-4B					
Mounting plate for adaptor PCB <sup>2,3,4</sup>		KRP4A98					
Central remote controller <sup>5</sup>		DCS302CA61					
Unified ON/OFF controller <sup>5</sup>		DCS301BA61					
Schedule timer <sup>5</sup>		DST301BA61					
Intelligent Touch Controller <sup>5</sup>		DCS601C51					

Note: <sup>1</sup>Wiring for wired remote controller to be procured locally.  
<sup>2</sup>Mounting plate is necessary for each adaptor marked \*.  
<sup>3</sup>Up to 2 adaptors can be fixed for each mounting plate.  
<sup>4</sup>Only one mounting plate can be installed for each indoor unit.  
<sup>5</sup>The indoor unit is equipped standardly with the interface adaptor for SkyAir series.  
The interface adaptor for SkyAir series is not necessary for this indoor unit since it is equipped as standard.

# Comfortable Airflow Travels Throughout The Room



FHQ50/60BVV1G  
FHQ71/100/125BVV1B  
FHQ100/125/140DA



## Benefits of DA series

- The technology of the DC fan motor, wide sirocco fan, and large heat exchanger combine for greater airflow and quiet operation.

High/Middle/Low : 46/42/38 dB(A)

- Sophisticated design  
Flap neatly closes when not in use.



Fresh white colour.

- Installable on ceilings 4.3 m high

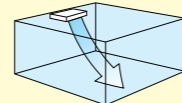

- 3 fan speeds: High/Middle/Low
- Connection to a centralised control system is available, without option.

## Comfortable

- Auto swing (up and down) and louvers (left and right by hand) bring comfort to the room
- Louver manually adjusts for straight or wide angle airflow
- Programme "Dry"  
Dehumidification is a microprocessor controlled to prevent abrupt and uncomfortable changes in air temperature.

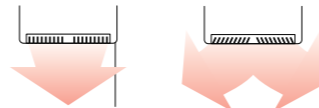

## Easy Maintenance

- Long-life filter (standard) requires no maintenance for about 1 year\*  
The filter is washable and reused after 1 year.  
\* For dust concentration of 0.15 mg/m<sup>3</sup>  
Two time settings (2500 hrs and 1250 hrs) are available to match the installation environment. Maintenance time warning is displayed on the remote controller (filter sign).
- Easy-clean, flat surfaces

## Drain pump kit can be easily incorporated

Drain pump kit (option) includes a silver ion antibacterial agent that assists in preventing the growth of slime, bacteria and mould that cause smells and clogging.

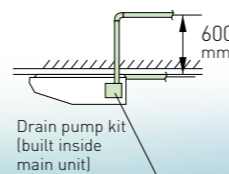

## SPECIFICATIONS

		50	60	71
Model Name	Indoor unit	FHQ50BVV1G	FHQ60BVV1G	FHQ71BVV1B
	Outdoor unit	RZR50LVVM	RZR60LVVM	RZR71LVVM
Power supply		1 Phase, 220-240 V, 50 Hz		
Cooling capacity <sup>1</sup> Rated (Min. - Max.)		5.0 [2.3-5.6] 17,100 [7,900-19,100]	6.0 [2.6-6.3] 20,500 [8,900-21,500]	7.1 [3.2-8.0] 24,200 [10,900-27,300]
		kW		
Power consumption	Cooling <sup>1</sup>	1.39	1.69	2.50
		W/W	3.60	3.56
Indoor unit	Colour	White		
	Airflow rate (H/L)	m <sup>3</sup> /min		
	Sound level (H/L) <sup>2</sup>	dB(A)		
	Dimensions (HxWxD)	mm		
	Machine weight	kg		
	Certified operation range	°CWB		
Outdoor unit	Colour	Ivory white		
	Compressor	Type	Hermetically sealed swing type	
		Motor output	1.12	1.35
	Refrigerant charge (R-410A)	kg		
	Sound level <sup>3</sup>	Cooling	48	
		Night quiet mode	44	
	Dimensions (HxWxD)	mm		
Machine weight	kg			
Certified operation range	°CDB			
Piping connections	Liquid (Flare)	mm		
	Gas (Flare)	mm		
	Drain	Indoor unit	mm	
		Outdoor unit	mm	
Max. interunit piping length		m		
Max. installation level difference		m		
Heat insulation		Both liquid and gas piping		

		100	125	100	125	140	
Model Name	Indoor unit	FHQ100BVV1B	FHQ125BVV1B	FHQ100DAVMA	FHQ125DAVMA	FHQ140DAVMA	
	Outdoor unit	RZR100LVVM	RZR125LVVM	RZR100MYM	RZR125MYM	RZR140MYM	
Power supply		1 Phase, 220-240 V, 50 Hz		3 Phase, 380-415 V, 50 Hz			
Cooling capacity <sup>1,2</sup> Rated (Min. - Max.)		10.0 [5.0-11.2] 34,100 [17,100-38,214]	12.5 [5.7-14.0] 42,700 [19,500-47,800]	10.0 [5.0-11.2] 34,100 [17,100-38,200]	12.5 [5.7-14.0] 42,700 [19,500-47,800]	14.0 [6.2-15.4] 47,800 [21,200-52,600]	
		kW					
Power consumption	Cooling <sup>1</sup>	3.51	4.55	3.03	4.42	5.55	
		W/W	2.85	2.75	3.3	2.83	2.52
Indoor unit	Colour	white		Light Ivory			
	Airflow rate (H/M/L)	m <sup>3</sup> /min					
	Sound level (H/M/L) <sup>2</sup>	dB(A)					
	Dimensions (HxWxD)	mm					
	Machine weight	kg					
	Certified operation range	°CWB					
Outdoor unit	Colour	Ivory white		Ivory white			
	Compressor	Type	Hermetically sealed swing type	Hermetically sealed scroll type	Hermetically sealed swing type		
		Motor output	2.03	2.6	1.92		
	Refrigerant charge (R-410A)	kg					
	Sound level <sup>3</sup>	Cooling	49	50	49	52	54
		Night quiet mode	45		46		
	Dimensions (HxWxD)	mm					
Machine weight	kg						
Certified operation range	°CDB						
Piping connections	Liquid (Flare)	mm					
	Gas (Flare)	mm					
	Drain	Indoor unit	mm		mm		
		Outdoor unit	mm		mm		
Max. interunit piping length		m			50 (Equivalent length 70)		
Max. installation level difference		m			30		
Heat insulation		Both liquid and gas piping			Both liquid and gas piping		

Note :  
<sup>1</sup>Rated cooling capacities are based on the following conditions: Indoor temp., 27°CDB, 19.0°CWB; outdoor temp. 35°CDB, 24°CWB. Equiv. refrigeration piping, 7.5 m (horizontal).  
<sup>2</sup>Capacities are net, including a deduction for cooling for indoor fan motor heat.  
<sup>3</sup>Anechoic chamber conversion value, measured according to JIS parameters and criteria. During operation these values are somewhat higher owing to ambient conditions.

## OPTIONS

Name of option	Remark	Kit name				
		FHQ50/60BVV1G	FHQ71BVV1B	FHQ100BVV1B	FHQ125BVV1B	FHQ100/125/140DAVMA
Replacement long-life filter	Resin net	KAF501DA80		KAF501DA112	KAF501DA160	KAF501A160
Drain pump kit		KDU50N125VE				
Remote controller	Wireless type	BRC7EA66				
	Wired type <sup>1</sup>	BRC1C61				
Navigation Remote Controller	Wired type <sup>1</sup>	BRC1E62				
Wiring adaptor for electrical appendices <sup>2</sup>		KRP4AA52				
Interface adaptor for SkyAir series		DTA112BA51		N/A		
Installation box for adaptor PCB		KRP1CA93		KRP1D93A		

Note :  
<sup>1</sup>Wiring for wired remote controller to be procured locally.  
<sup>2</sup>Installation box for adaptor PCB (KRP1D93A) is necessary.

## Quiet Operation at 32\*\* dB(A)

\*\*Selected models only

Uses quiet stream fan and other quiet technologies.  
(FHQ50-125BV)

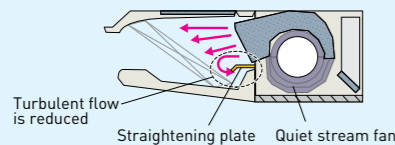

## Oil Resistant Grille

- Oil-resistant plastic is used for the air suction grille. This satisfies durability in restaurants and other similar environments.

Note: Intended for use in salons, dining rooms, and ordinary sales floors, this specification is not suitable for kitchens or other harsh environments.



# Compact Design and Easy Installation



## Comfortable

- Auto swing

Wide-angle louvers (by hand)  
Soft material louver bends airflow over a wider area

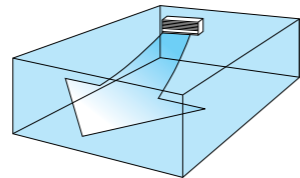
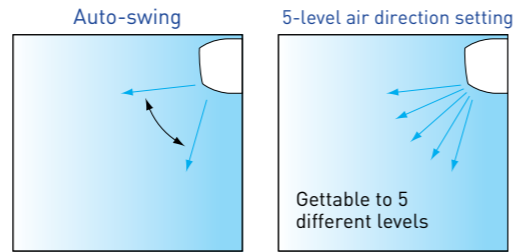
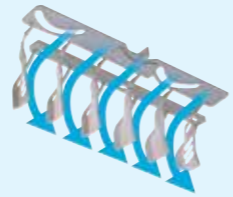

- Switchable fan speed : High / Middle / Low
- Auto airflow rate (When BRC1E62 is used)
- Programme "Dry"

Dehumidification is microprocessor controlled to prevent abrupt and uncomfortable changes in air temperature.

## Drain Pump Kit is Available as Option.

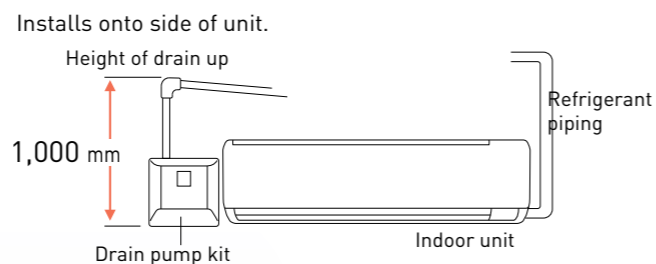

Connection to a centralised control system is available without option

## SPECIFICATIONS

		71	100	100	
Model Name	Indoor unit	FAQ71CVEA	FAQ100CVEA	FAQ100CVEA	
	Outdoor unit	RZR71LVVM	RZR100LVVM	RZR100MYM	
Power supply		1 Phase, 220-240 V, 50 Hz		3 Phase, 380-415 V, 50 Hz	
Cooling capacity <sup>1,2</sup> Rated (Min. - Max.)		kW 7.1 (3.2-8.0) Btu/h 24,200 (10,900-27,300)	10.0 (5.0-11.2) 34,100 (17,100-38,200)		
Power consumption	Cooling <sup>1</sup>	kW 2.19		3.37	
COP		W/W 3.24		2.97	
Indoor unit	Colour	Fresh white			
	Airflow rate (H/M/L)	m <sup>3</sup> /min 18/16/14	26/23/19		
	Sound level (H/M/L) <sup>3</sup>	dB(A) 45/42/40	49/45/41		
	Dimensions (HxWxD)	mm 290x1,050x238	340x1,200x240		
	Machine weight	kg 13	17		
Certified Operation range		°CWB 14 to 25			
Outdoor unit	Colour	Ivory white			
	Compressor	Type	Hermetically sealed swing type		
		Motor output	kW 1.76	2.03	1.92
	Refrigerant charge (R-410A)	kg 1.6 (Charged for 30 m)	3.35 (Charged for 30 m)	1.9 (Charged for 30 m)	
	Sound level <sup>3</sup>	Cooling	dB(A) 48	49	
		Night quiet mode	dB(A) 44	45	
	Dimensions (HxWxD)	mm 595x845x300	900x940x320		
	Machine weight	kg 43	78	73	
Certified Operation range		°CDB 21 to 46			
Piping connections	Liquid (Flare)	mm φ 9.5			
	Gas (Flare)	mm φ 15.9			
	Drain	Indoor unit	VP13 (I.D. φ 13 x O.D. φ 18)		
Outdoor unit		mm φ 26.0 (Hole)			
Max. interunit piping length		m 50 (Equivalent length 70m)			
Max. installation level difference		m 30			
Heat insulation		Both liquid and gas piping			

Note :  
<sup>1</sup>Rated cooling capacities are based on the following conditions: Indoor temp., 27°CDB, 19.0°CWB; outdoor temp. 35°CDB, 24°CWB. Equiv. refrigeration piping, 7.5 m (horizontal).  
<sup>2</sup>Capacities are net, including a deduction for cooling for indoor fan motor heat.  
<sup>3</sup>Anechoic chamber conversion value, measured according to JIS parameters and criteria. During operation these values are somewhat higher owing to ambient conditions.

## OPTIONS

Name of option	Remark	Kit name	
		FAQ71CVEA	FAQ100CVEA
Drain-up kit		K-KDU572EVE	
Remote controller	Wireless type	Cooling only BRC7EB519	
	Wired type <sup>1</sup>	BRC1C61	
Navigation Remote Controller	Wired type <sup>1</sup>	BRC1E62	
Wiring adaptor for electrical appendices		KRP4AA51	
Installation box for adaptor PCB		KRP4AA93	

Note: <sup>1</sup>Wiring for wired remote controller to be procured locally.

## Compact & Sophisticated Design

- FAQ100

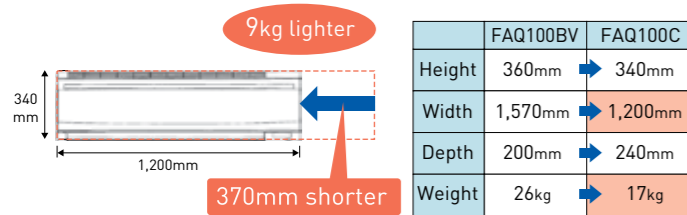

## Easy Cleaning

- Removable and washable grille

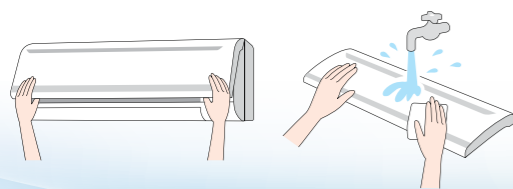

- Flat panel, easy to wipe dust off

## New Airflow Control for More Comfort



FVQ50/60/71/100/125/140C



### New Comfortable Airflow Control

- 1) Left and right directions (by remote controller)
  - Auto swing direction is selectable from 3 patterns to suit the layout of the room.

[Applicable when BRC1E62 is used.]

Pattern 1 Wide swing toward the front

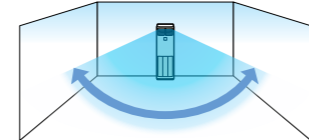

When installed in the center of a wall.

Pattern 2 Swing on the left side

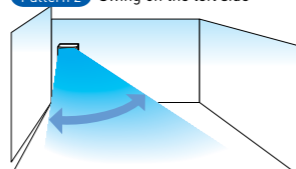

Pattern 3 Swing on the right side

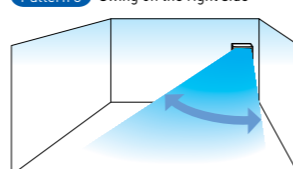

When installed in the corner of a room.

### 2) Up and down directions (by hand)

- Independent up-and-down airflow directions facilitate even room temperature and help save energy.

Freely select both up and down airflow direction with 8-louver (horizontal blade) operation.

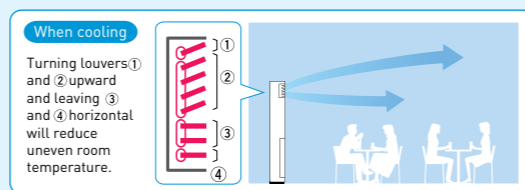

When cooling

Turning louvers ① and ② upward and leaving ③ and ④ horizontal will reduce uneven room temperature.

### Quiet Operation at 38\*\* dB(A)

\*\*Selected models only

### Comfortable Fan Speed Control

- Switchable fan speed: High/Middle/Low and Auto ("Auto" is applicable when BRC1E62 is used.)
- Auto airflow rate ie selectable. Airflow rate is automatically controlled in accordance with the difference between room temperature and set temperature.
- High fan speed mode (applicable for FVQ50-100) To carry airflow to the far side of the room, airflow rate can be increased 5% or 10% depending on the installation condition or customer's request. (Field setting by remote controller.)
- Programme "Dry" Dehumidification is microprocessor controlled to prevent abrupt and uncomfortable changes in air temperature.

### Energy Saving

- A DC fan motor improves efficiency.

### Long-Life Filter Lasts about 1 year\* Maintenance not required

\*For dust concentration of 0.15 mg/m<sup>3</sup>

## SPECIFICATIONS

		50	60	71	100	125	100	125	140	
Model Name	Indoor unit	FVQ50CVE	FVQ60CVE	FVQ71CVEB	FVQ100CVEB	FVQ125CVEB	FVQ100CVEB	FVQ125CVEB	FVQ140CVEB	
	Outdoor unit	RZR50LVVM	RZR60LVVM	RZR71LVVM	RZR100LVVM	RZR125LVVM	RZR100MYM	RZR125MYM	RZR140MYM	
Power supply	Outdoor unit	1 Phase, 220-240 V, 50 Hz					3 Phase, 380-415 V, 50 Hz			
Cooling capacity <sup>1,2</sup> Rated (Min. - Max.)	kW	5.0 (2.3-5.6)	6.0 (2.6-6.3)	7.1 (3.2-8.0)	10.0 (5.0-11.2)	12.5 (5.7-14.0)	10.0 (5.0-11.2)	12.5 (5.7-14.0)	14.0 (6.2-15.4)	
	Btu/h	17,100 (7,900-19,100)	20,500 (8,900-21,500)	24,200(10,900-27,300)	34,100 (17,100-38,200)	42,700 (19,500-47,800)	34,100 (17,100-38,200)	42,700 (19,500-47,800)	47,800 (21,200-52,600)	
Power consumption	Cooling <sup>1</sup>	kW	1.27	1.84	2.58	3.28	4.39	3.28	4.62	
	W/W		3.94	3.26	2.75	3.05	2.85	3.05	2.71	
Indoor unit	Colour	Fresh white								
Fan	Airflow rate (H/M/L)	18/16/14			28/25/22		28/26/24		30/28/26	
	Cooling (H/M/L)	43/41/38			50/47/44		51/48/46		50/47/44	
Sound level <sup>3</sup>	Cooling (H/M/L)	43/41/38			50/47/44		51/48/46		53/51/48	
Dimensions (H×W×D)	mm	1,850×600×270			1,850×600×350		1,850×600×350		1,850×600×350	
Machine weight	kg	39			47		47		47	
Certified Operation range	Cooling °CWB	14 to 25								
Outdoor unit	Colour	Ivory white								
Compressor	Type	Hermetically sealed swing type				Hermetically sealed scroll type		Hermetically sealed swing type		
	Motor output	kW	1.12	1.35	1.76	2.03	2.4	1.92		
Refrigerant charge (R-410A)	kg	1.6		2.7		3.15		1.9		
	(Charged for 30 m)	[Charged for 30 m]		[Charged for 30 m]		[Charged for 30 m]		[Charged for 30 m]		
Sound level <sup>3</sup>	Cooling	48		49		50		49		
	Night quiet mode	44		45		45		45		
Dimensions (H×W×D)	mm	595×845×300			990×940×320		1,170×900×320		990×940×320	
Machine weight	kg	43			78		97		73	
Certified Operation range	Cooling °CDB	21 to 46								
Piping connections	Liquid (Flare)	φ 9.5								
	Gas (Flare)	φ 15.9								
	Drain	VP20 (I.D. φ 20×O.D. φ 26)								
	Indoor unit	φ 26.0 (Hole)								
	Outdoor unit	φ 26.0 (Hole)								
Max. interunit piping length	m	50 (Equivalent length 70)								
Max. installation level difference	m	30								
Heat insulation		Both liquid and gas piping								

Note :

<sup>1</sup> Rated cooling capacities are based on the following conditions: Suction temp., 27°CDB, 19.0°CWB; outdoor temp. 35°CDB, 24°CWB. Equiv. refrigeration piping, 7.5 m (horizontal)

<sup>2</sup> Capacities are net, including a deduction for cooling for indoor fan motor heat.

<sup>3</sup> Anechoic chamber conversion value, measured according to JIS parameters and criteria. During operation these values are somewhat higher owing to ambient conditions.

## OPTIONS

Name of option	Remark	Kit name					
		FVQ50CVE	FVQ60CVE	FVQ71CVEB	FVQ100CVEB	FVQ125CVEB	FVQ140CVEB
Remote controller	Wired type <sup>1</sup>	BRC1C61					
Navigation Remote Controller	Wired type <sup>1</sup>	BRC1E62					
Wiring adaptor for electrical appendices		KRP4AA52					
Installation box for adaptor PCB		KRP4AA95					







Note: <sup>1</sup>Wiring for wired remote controller to be procured locally.

# Functions overview

Cooling only

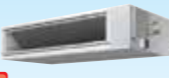
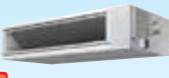
Indoor unit

Outdoor unit

		CEILING MOUNTED CASSETTE TYPE (Round Flow)		DUCT CONNECTION MIDDLE and HIGH STATIC PRESSURE TYPE	CEILING SUSPENDED TYPE		WALL MOUNTED TYPE	FLOOR STANDING TYPE
		 						
		FCQ50-71LUV1	<b>NEW</b> FCQ100-140KAVEA	<b>NEW</b> FBQ50-140EVE	FHQ50/60BVV1G FHQ71-125BVV1B	<b>NEW</b> FHQ100-140DAVMA	FAQ71/100CVEA	FVQ50/60CVE FVQ71-140CVEB
		RZR50-60LVVM RZR71LVVMG	RZR100-125MVMG, RZR100-140MYM	RZR50-60LVVM,RZR71LVVMG RZR100-125MVMG, RZR100-140MYM	RZR50-125LVVM	RZR100-140MYM	RZR71-100LVVM RZR100MYM	RZR50-125LVVM RZR100-140MYM
Comfort	Auto swing	●	●		●	●	●	●
	Swing pattern selection	●	●					
	Independent up-and-down airflow							●
	DC fan motor (Indoor unit)	●	●	●		●	●	●
	Switchable fan speed	2step	3step	3step	2step	3step for DA	3step	3step
	Auto airflow rate*1			●			●	●
	High fan speed mode						●	●*5
	Program "Dry"	●	●	●	●	●	●	●
	High ceiling application	●	●		●*6	●*6		
	Two selectable temperature-sensors *2	●	●	●	●		●	●
	Year-round cooling applicable							
	Night quiet operation *3	●	●	●	●	●	●	●
Remote Controller	Setpoint auto reset *1	●	●	●	●	●	●	●
	Setpoint range set *1	●	●	●	●	●	●	●
	Weekly schedule timer *1	●	●	●	●	●	●	●
	Off timer (programmed) *1	●	●	●	●	●	●	●
	On/Off timer *4	●	●	●	●	●	●	●
Cleanliness	Anti-bacterial air filter	●	●	●*8	●	●		●
	Mould-proof air filter						●	
	Silver ion anti-bacterial drain pan	●	●	●				
	Mould-proof drain pan							
Work & servicing	Drain pump mechanism	●	●	●	●*8	●*8	●*8	
	Pre-charged for up to 30 m *3	●	●	●	●	●	●	●
	Pre-charged for up to 10 m *3							
	Long-life filter	●	●	●*8	●	●		●
	Filter sign	●	●	●	●	●	●	●
	Ceiling soiling prevention	●	●					
	Low gas pressure detection *3	●	●	●	●	●	●	●
	Emergency operation	●	●	●	●	●	●	●
Self-diagnosis function	●	●	●	●	●	●	●	
Control features	Auto-restart	●	●	●	●	●	●	●
	Control by 2 remote controllers	●	●	●	●	●	●	●
	Group control by 1 remote controller	●	●	●	●	●	●	●
	External command control	●*8	●*8	●*8	●*8	●*8	●*8	●*8
	Central remote control	●	●	●	●*8 *8 BV series needs option	●	●	●
	Interlock control with Heat Reclaim Ventilator	●	●	●	●	●	●	●
	DIII-NET communication standard	●	●	●		● Only for DA series	●	●
Options	High-efficiency filter	●	●	●				
	Ultra long-life filter	●	●					
	Fresh air intake kit	●	●			● Only for DA series		
Others	Anti corrosion treated heat exchangers *3	●	●*10	●*10	●	●	●*10	●*10

Note: \*1 : Applicable when BRC1E62 is used

\*2 : Applicable when wired remote controller is used

\*3 : For outdoor units

\*4 : Applicable when BRC1C61 is used

\*5 : Applicable for FVQ50-100

\*6 : Installable on max. 3.5 m (50-71)  
and 4.3 cm.(100-140 ) high ceiling

\*7 : Installable on max. 4.3 m high ceiling

\*8 : Option

\*9 : Applicable for 60/71 class indoor unit

\*10 : Applicable for RZR50-71M, RZR-LV and RZR-LU

# Function Directory

## Comfort

### Auto-swing

Delivers comfortable air-conditioning to all areas, near to and far from the air-conditioner.

The air flow direction can be fixed at your desired angle by the remote controller.

### Swing pattern selection

You can freely set air discharge setting by remote controller.

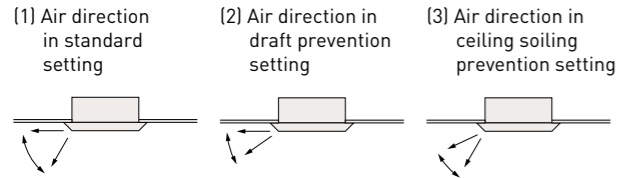

### Independent up-and-down airflow

Independently adjust (manually) the eight horizontal blade louvers in both up and down directions to achieve an airflow that reduces uneven room temperature.

### Switchable fan speed

High setting provides maximum reach while low setting minimises drafts.

### Auto airflow rate

Airflow rate is automatically controlled in accordance with the difference between room temperature and set temperature.

### High fan speed mode

You can increase fan speed approximately 10% higher than the "high" setting.

### Programme "Dry"

Dehumidification is microprocessor controlled to prevent abrupt and uncomfortable changes in air temperature. Useful for reducing uncomfortable humidity without uncomfortable cooling of the room.

### High-ceiling application

Delivers air-conditioning comfort all the way down to the floor in air-conditioning zones with high ceilings.

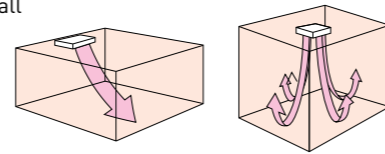

Note: When units are installed on high ceilings, depending on the model, various restrictions concerning maximum height, air discharge direction, and choice of options may apply.

### Two selectable temperature-sensors

Temperature-sensors are included in the indoor unit and optional wired remote controller. Temperature sensing closer to target area is possible to further increase the comfort level.

- Use the temperature-sensor in the indoor unit when controlling air conditioning from another room.

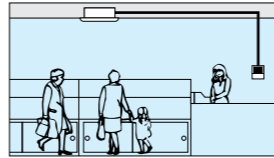

Note: Wireless remote controllers have no temperature-sensor.

### Night quiet operation

The Automatic night quiet mode will initiate 8 hours after the peak temperature is reached in the daytime, and normal operation will resume 10 hours after that.

## Remote Controller

### Setpoint auto reset

Even if the set temperature is changed, it returns to the preset temperature after a preset period of time.

### Setpoint range set

Saves energy by limiting the minimum and maximum set temperatures. Avoids excessive heating and cooling.

### Weekly schedule timer

Up to five operation ON/OFF settings can be programmed per day for each day of the week. Not only can the time be set for the operation ON setting, but also the temperature.

### Off timer (programmed)

Sets and saves setting for an increment of time that automatically turns off air conditioner after a preset period of time for each time operation starts.

### On/Off timer

Operation starts when the preset time of the ON timer elapses and stops when the preset time of the OFF timer elapses.

## Cleanliness

### Anti-bacterial air filter

The Air filter has a anti-bacterial treatment to help prevent the growth of bacteria and mould on it.

### Mould-proof drain pan

Mould-proof drain pan prevents growth of mould in highly humid conditions.

### Mould-proof air filter

Sanitary filter has mould-resistant treatment.

### Silver ion anti-bacterial drain pan

Mould-proof drain pan includes a silver ion antibacterial agent that assists in preventing the growth of slime, bacteria, and mould that cause smells and clogging.

## Work and Servicing

### Drain pump mechanism

Steeper gradient realises more efficient condensate drainage. High-lift is especially useful for long lengths of drain piping.

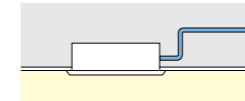

### Pre charged for up to 30 metres

If refrigerant piping length does not exceed 30 m, there is no need for on-site gas charging.

\*Applicable to RZR50-140.  
RXS50FA/60F/71F,RKS25A/35A : 10 m

### Long-life filter

Maintenance is not required for one year\*. The filter is washable and can be reused.

\*For dust concentration of 0.15 mg/m<sup>3</sup>

### Filter sign

The filter sign warns you when it is time to clean the filter.

\*When using a wired remote controller the sign is displayed in the LCD. When using a wireless remote controller the filter sign lamp illuminates on the signal receiver unit.

### Ceiling soiling prevention function

Daikin's innovative air discharge mechanism keeps airflow away from the ceiling. Ceiling cleaning is less frequently required.

### Low gas pressure detection

Insufficient gas charging is normally hard to detect. During post-installation trials and regular inspection procedures, the refrigerant level is monitored by microprocessor to maintain proper gas pressure. Reliability is assured and maintenance and inspection can be carried out more quickly.

### Emergency operation

If there is a malfunction elsewhere in the system, the fan or compressor can still be operated.

### Self diagnosis function

The operating parameters of indoor and outdoor units, and sensor data at critical locations throughout the system, are constantly monitored using a microcomputer. To facilitate quick response in the event of a malfunction, a message appears on the LCD of the remote controller and an LED on the unit illuminates.

## Control features

### Auto-restart

If there is a power outage while the equipment is operating, operations will restart in the same mode as before the power cut when electricity is restored.

### Control by 2 remote controllers

Using 2 remote controllers you can operate the equipment locally or from a remote location.

Note: It is not possible to use two wireless remote controllers.

### Group control by 1 remote controller

You can turn up to 16 indoor units on/off with a single remote controller. (When using connected indoor units, the settings must all be the same and on/off will be simultaneous.)

### External command control

Operation and surveillance is carried out using the contact signal from the operation control box in the building surveillance (security) room.

\*An option is required.

### Central remote control

Optional central remote controller enables centralised control of up to 1024 indoor units (64 groups) from up to 1 kilometer away.

### Interlock control

Enables interlocking control with external equipment such as Heat Reclaim Ventilator.

### DIII-NET communication standard

Standardly equipped interface enables connection to centralised control system without need of an adaptor.

## Options

### High-efficiency filter unit

Two types are available: 65% and 90% colorimetry.

### Ultra long-life filter

Requires no maintenance for about 4 years\* (10,000h) in stores and offices.

\*For dust concentration of 0.15 mg/m<sup>3</sup>

### Fresh-air intake kit

You can provide air-conditioning with fresh air from outside. Convenient for places where a ventilation fan cannot be installed.

Note: \*Connecting ducts, insect nets, fire dampers, air filters, and other parts should, as required, be procured locally.  
\*\*Outside Air fan interlocked with air conditioning unit is necessary. Optional PCB(KRP1C63) is required for interlocking.  
\*\*\*It is recommended that the volume of outdoor air introduced through the kit is limited to 10% of the maximum airflow rate of the indoor unit. Introducing higher quantities will increase the operating noise and may also influence temperature sending.

## Others

### Anti corrosion treated heat exchangers

To achieve increased durability by improved resistance to salt corrosion and atmospheric pollution, coated Anti corrosion treated heat exchangers (with special acryl pretreatment) are used for the heat exchanger of the outdoor unit. In high corrosive areas, regular maintenance needs to be carried out.

## Easy-to-read LCD remote controller allows various system control configurations and can control multiple indoor units.

### Navigation Remote Controller (Wired Remote Controller BRC1E62)



This simple, modern designed remote controller with fresh white colour matches your interior design. Operation is much easier and smoother, just follow the indications on the navigation remote controller.

#### Clear Display with Backlight

Backlight display



#### Convenience

Weekly schedule

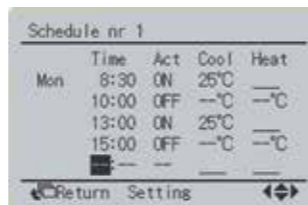

### Energy saving

#### Setpoint auto reset

- Even if the set temperature is changed, it returns to the preset temperature after a preset period of time.
- Period selectable from 30min/60min/90min/120min.

#### Restaurant sample

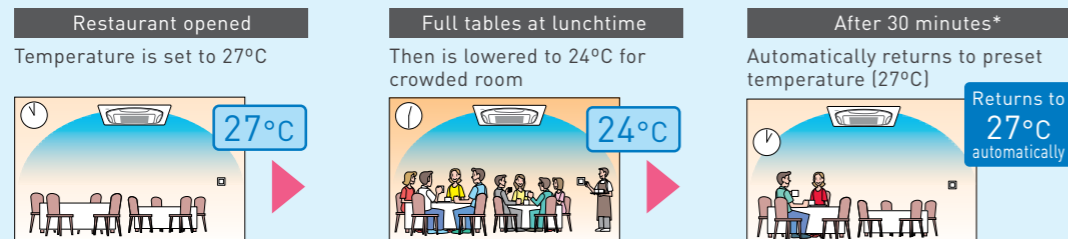

\*Setting possible for after 30, 60, 90, and 120 minutes.

#### Off timer (programmed)

- Sets and saves setting for an increment of time that automatically turns off air conditioner after a preset period of time for each time operation starts.
- Period can be preset from 30 to 180 minutes in 10-minute increments.

#### Setpoint range set

- Saves energy by limiting the min. and max. set temperature.
- Avoids excessive heating or cooling.
- This function is convenient when the remote controller is installed at a place where any number of people may operate it.

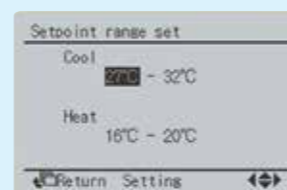

### Wired LCD remote controller



BRC1C61

Easy to read because of large LCD screen.

- The rubber switch and the oil-resistant plastic casing are adopted for durability.
- Only 17 mm thick. Can be installed either recessed or exposed.

### LCD wireless remote controller



Wireless remote controller



BRC7GA56  
Signal receiver unit  
(For FHQ140CA)

- The wireless remote controller is supplied in a set with a signal receiver.
- Signal receiver unit is contained inside decoration panel or indoor unit
- Shape of signal receiver unit differs according to the indoor unit.

Note: The signal receiver unit shown in the photograph is for mounting inside the decoration panel of the ceiling suspended type.

### Easily adaptable to large-scale, high-function, centralised remote control system.

#### Central remote controller

DCS302CA61 (Option)



Centralised control, with setting as simple as it is with a standard remote controller, of up to 64 groups (1,024 indoor units) is possible.

#### Unified on/off controller

DCS301BA61 (Option)



Centralised control of on/off by group or all at once for up to 256 indoor units.

#### Schedule timer

DST301BA61 (Option)



Unified control of weekly schedule for up to 1,024 indoor units.  
Schedule timer sets on/off time in 1 minute units to be executed twice a day for a week at a time.

#### Intelligent Controller

DCS601C51 (Option)



With its high functionality, the full colour "all-in-one" graphic controller facilitates management of SkyAir System in a variety of ways.

#### Interface adaptor for SkyAir series

DTA112BA51 (Option)

Enables centralised control via connection to a high-speed, DIII-NET communication system, adopted for the Daikin VRV system.

Necessary for interface adaptor for SkyAir series with the central remote control units shown at above.

- The interface adaptor for the SkyAir series is optional except for the ceiling mounted cassette type < Round Flow >, duct connection middle static (CA/DA series) pressure type, ceiling suspended type (140cA only), wall mounted type and floor standing type.

NOTE

NOTE