SPLIT SYSTEM**Air Conditioner**

English

Español

中文
(繁體)中文
(简体)

عربي

MODELS

(Ceiling-mounted Multi flow Cassette type)

FH(Y)C35KVE(9)**FH(Y)C50KVE(9)****FH(Y)C60KVE(9)****FH(Y)C71KVE(9)****FH(Y)C100KVE(9)****FH(Y)C125KVE(9)****FHYC140KVE**

Thank you for purchasing this Daikin air conditioner. Carefully read this operation manual before using the air conditioner. It will tell you how to use the unit properly and help you if any trouble occurs. After reading the manual, file it away for future reference.

Le agradecemos la compra de este acondicionador de aire Daikin.
Lea cuidadosamente el manual de funcionamiento antes de utilizar el acondicionador de aire. Dicho manual le indicará cómo utilizar adecuadamente la máquina y le ayudará en caso de avería. Después de leer el manual, consérvelo para consultas futuras.

感謝您購買大金的空調機。
在使用本空調機之前，請仔細閱讀本使用說明書。
本說明書說明空調機的正确的使用方法，和發生故障時的對應措施。閱讀完畢本說明書後，請妥善保管，以備需要時查閱。

感谢您购买大金的空调机。
在使用本空调机之前，请仔细阅读本使用说明书。
本说明书说明空调机的正确的使用方法，和发生故障时的对应措施。阅读完毕本说明书后，请妥善保管，以备需要时查阅。

شكرا على شرائك مكيف الهواء من دايكين. قم بقراءة دليل التشغيل هذا بعناية قبل استعمال مكيف الهواء. سيخبرك كيف تقوم باستعمال هذه الوحدة بطريقة صحيحة وسيساعدك عند حدوث اي مشاكل. بعد قراءة هذا الدليل، احتفظ به بعيدا للرجوع اليه في المستقبل.

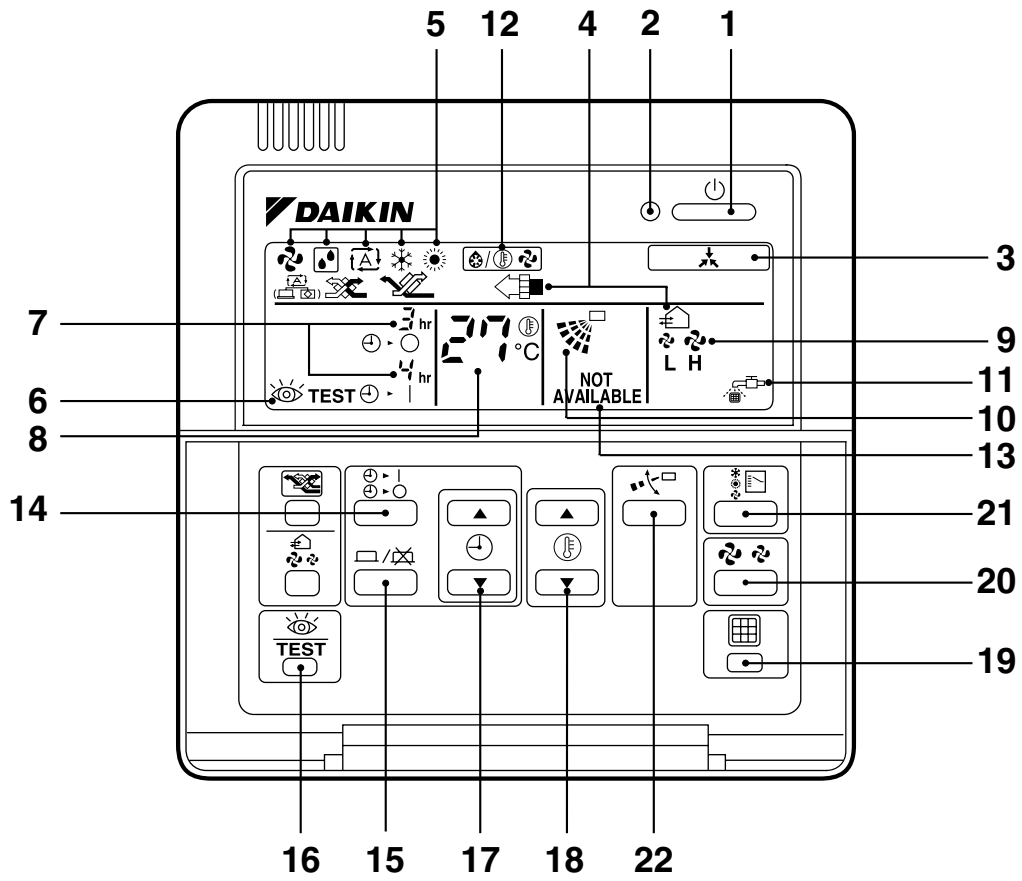

1

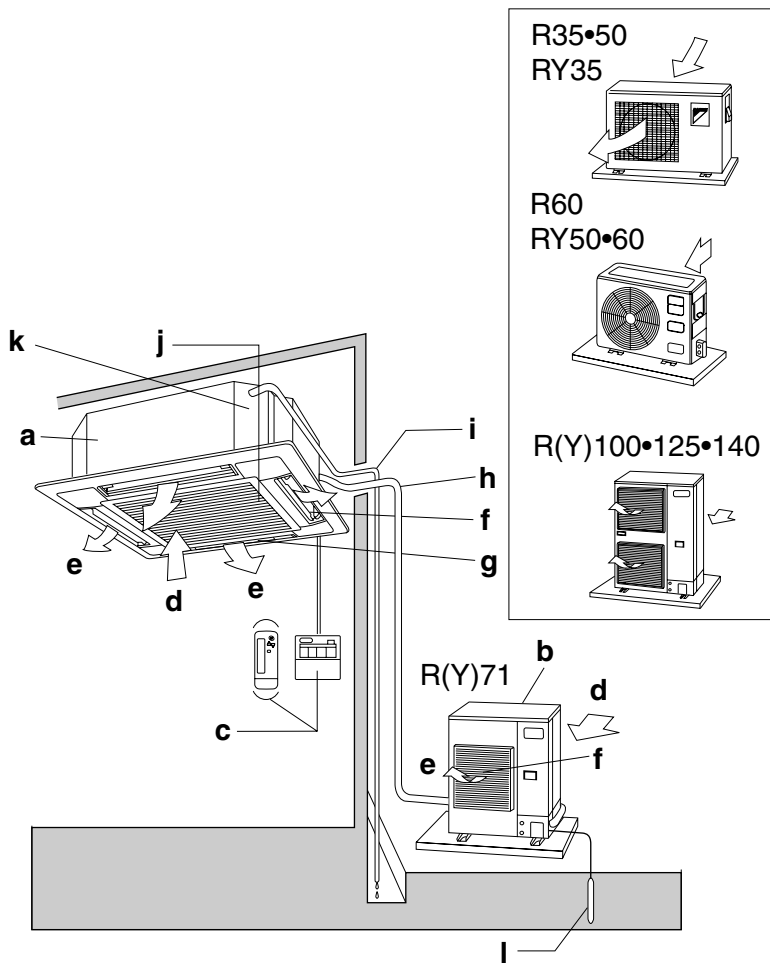

2

[1]

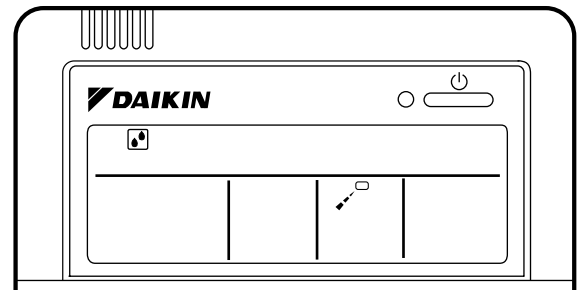

3

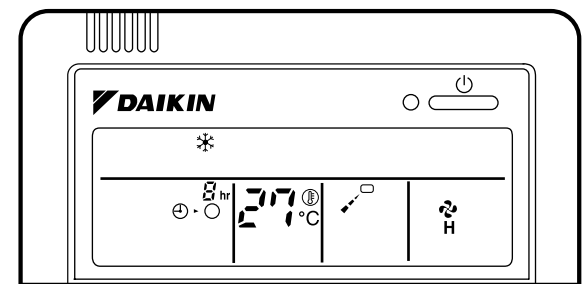

4

CONTENTS

| | |
|---|-----|
| ILLUSTRATIONS..... | [1] |
| 1. WHAT TO DO BEFORE OPERATION..... | 1 |
| 2. SAFETY PRECAUTIONS..... | 2 |
| 3. OPERATION RANGE..... | 4 |
| 4. INSTALLATION SITE..... | 4 |
| 5. NAME AND FUNCTION OF EACH SWITCH AND DISPLAY ON THE REMOTE CONTROLLER..... | 5 |
| 6. OPERATION PROCEDURE..... | 6 |
| 7. OPTIMUM OPERATION..... | 8 |
| 8. MAINTENANCE (FOR SERVICE PERSONNEL)..... | 8 |
| 9. NOT MALFUNCTION OF THE AIR CONDITIONER..... | 10 |
| 10. TROUBLE SHOOTING..... | 11 |
| 11. SPECIFICATIONS..... | 13 |

1. WHAT TO DO BEFORE OPERATION

This operation manual is for the following systems with standard control. Before initiating operation, contact your Daikin dealer for the operation that corresponds to your system.

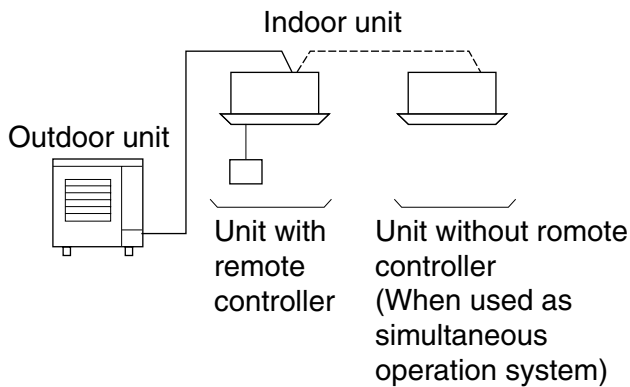

NOTE

- If the unit you purchased is controlled by a wireless remote controller, also refer to the wireless remote controller's operation manual.

If your installation has a customized control system, ask your Daikin dealer for the operation that corresponds to your system.

- Heat pump type
This system provides cooling, heating, automatic, program dry, and fan operation modes.

- Cooling only type
This system provides cooling, program dry, and fan operation modes.

PRECAUTIONS FOR GROUP CONTROL SYSTEM OR TWO REMOTE CONTROLLER CONTROL SYSTEM

This system provides two other control systems beside individual control (one remote controller controls one indoor unit) system. Confirm the following if your unit is of the following control system type.

- **Group control system**
One remote controller controls up to 16 indoor units.
All indoor units are equally set.
- **Two remote controller control system**
Two remote controllers control one indoor unit (In case of group control system, one group of indoor units)
The unit is individually operated.

NOTE

- Contact your Daikin dealer in case of changing the combination or setting of group control and two remote controller control systems.

Names and functions of parts

Refer to figure 2 on page [1]

| | |
|----------|--|
| a | Indoor unit |
| b | Outdoor unit |
| c | Remote controller |
| d | Inlet air |
| e | Discharged air |
| f | Air outlet |
| g | Air flow flap (at air outlet) |
| h | Refrigerant piping, connection electric wire |
| i | Drain pipe |
| j | Air inlet The built-in air filter removes dust and dirt. |
| k | Drain pumping out device(built-in) Drains water removed from the room during cooling. |
| l | Ground wire Wire to ground from the outdoor unit to prevent electrical shocks. |

2. SAFETY PRECAUTIONS

To gain full advantage of the air conditioner's functions and to avoid malfunction due to mishandling, we recommend that you read this instruction manual carefully before use.

This air conditioner is classified under "appliances not accessible to the general public".

- **The precautions described herein are classified as WARNING and CAUTION. They both contain important information regarding safety. Be sure to observe all precautions without fail.**

⚠ WARNING .. Failure to follow these instructions properly may result in personal injury or loss of life.

⚠ CAUTION ... Failure to observe these instructions properly may result in property damage or personal injury, which may be serious depending on the circumstances.

- **After reading, keep this manual in a convenient place so that you can refer to it whenever necessary. If the equipment is transferred to a new user, be sure also to hand over the manual.**

⚠ WARNING

Be aware that prolonged, direct exposure to cool or warm air from the air conditioner, or to air that is too cool or too warm can be harmful to your physical condition and health.

When the air conditioner is malfunctioning (giving off a burning odour, etc.) turn off power to the unit and contact your local dealer.

Continued operation under such circumstances may result in a failure, electric shocks or fire hazards.

Consult your local dealer about installation work.

Doing the work yourself may result in water leakage, electric shocks or fire hazards.

Consult your local dealer regarding modification, repair and maintenance of the air conditioner.

Improper workmanship may result in water leakage, electric shocks or fire hazards.

Do not place objects, including rods, your fingers, etc., in the air inlet or outlet.

Injury may result due to contact with the air conditioner's highspeed fan blades.

Beware of fire in case of refrigerant leakage.

If the air conditioner is not operating correctly, i.e. not generating cool or warm air, refrigerant leakage could be the cause.

Consult your dealer for assistance.

The refrigerant within the air conditioner is safe and normally does not leak.

However, in the event of a leakage, contact with a naked burner, heater or cooker may result in generation of noxious gas.

Do not longer use the air conditioner until a qualified service person confirms that the leakage has been repaired.

Consult your local dealer regarding what to do in case of refrigerant leakage.

When the air conditioner is to be installed in a small room, it is necessary to take proper measures so that the amount of any leaked refrigerant does not exceed the concentration limit in the event of a leakage. Otherwise, this may lead to an accident due to oxygen depletion.

Contact professional personnel about attachment of accessories and be sure to use only accessories specified by the manufacturer.

If a defect results from your own workmanship, it may result in water leaks, electric shock or fire.

Consult your local dealer regarding relocation and reinstallation of the air conditioner.

Improper installation work may result in leakage, electric shocks or fire hazards.

Be sure to use fuses with the correct ampere reading.

Do not use improper fuses, copper or other wires as a substitute, as this may result in electric shock, fire, injury or damage to the unit.

Be sure to earth the unit.

Do not earth the unit to a utility pipe, lightning conductor or telephone earth lead. Imperfect earthing may result in electric shocks or fire. A high surge current from lightning or other sources may cause damage to the air conditioner.

Be sure to install an earth leakage breaker.

Failure to install an earth leakage breaker may result in electric shocks or fire.

Consult the dealer if the air conditioner submerges owing to a natural disaster, such as a flood or typhoon.

Do not operate the air conditioner in that case, or otherwise a malfunction, electric shock, or fire may result.

Do not start or stop operating the air conditioner with the power supply breaker turned ON or OFF.

Otherwise, fire or water leakage may result. Furthermore, the fan will rotate abruptly if power failure compensation is enabled, which may result in injury.

Do not use the product in the atmosphere contaminated with oil vapor, such as cooking oil or machine oil vapor.

Oil vapor may cause crack damage, electric shocks, or fire.

Do not use the product in places with excessive oily smoke, such as cooking rooms, or in places with flammable gas, corrosive gas, or metal dust.

Using the product in such places may cause fire or product failures.

Do not use flammable materials (e.g., hair-spray or insecticide) near the product.

Do not clean the product with organic solvents such as paint thinner.

The use of organic solvents may cause crack damage to the product, electric shocks, or fire.

Be sure to use a dedicated power supply for the air conditioner.

The use of any other power supply may cause heat generation, fire, or product failures.

⚠ CAUTION

Do not use the air conditioner for purposes other than those for which it is intended.

Do not use the air conditioner for cooling precision instruments, food, plants, animals or works of art as this may adversely affect the performance, quality and/or longevity of the object concerned.

Do not remove the outdoor unit's fan guard.

The guard protects against the unit's high speed fan, which may cause injury.

Do not place objects that are susceptible to moisture directly beneath the indoor or outdoor units.

Under certain conditions, condensation on the main unit or refrigerant pipes, air filter dirt or drain blockage may cause dripping, resulting in fouling or failure of the object concerned.

To avoid oxygen depletion, ensure that the room is adequately ventilated if equipment such as a burner is used together with the air conditioner.

After prolonged use, check the unit stand and its mounts for damage.

If left in a damaged condition, the unit may fall and cause injury.

Do not place flammable sprays or operate spray containers near the unit as this may result in fire.

Before cleaning, be sure to stop unit operation, turn the breaker off or remove the power cord.

Otherwise, an electric shock and injury may result.

To avoid electric shocks, do not operate with wet hands.

Do not place appliances that produce naked flames in places exposed to the air flow from the unit as this may impair combustion of the burner.

Do not place heaters directly below the unit, as resulting heat can cause deformation.

Do not allow a child to mount on the outdoor unit or avoid placing any object on it.

Falling or tumbling may result in injury.

Do not block air inlets nor outlets.

Impaired air flow may result in insufficient performance or trouble.

Be sure that children, plants or animals are not exposed directly to airflow from the unit, as adverse effects may ensue.

Do not wash the air conditioner with water, as this may result in electric shocks or fire.

Do not install the air conditioner at any place where there is a danger of flammable gas leakage.

In the event of a gas leakage, build-up of gas near the air conditioner may result in fire hazards.

Do not put flammable containers, such as spray cans, within 1 m from the blow-off mouth.

The containers may explode because the warm air output of the indoor or outdoor unit will affect them.

Arrange the drain hose to ensure smooth drainage.

Imperfect drainage may cause wetting.

The appliance is not intended for use by unattended young children or infirm persons.

Impairment of bodily functions and harm to health may result.

Children should be supervised to ensure that they do not play with the unit or its remote controller.

Accidental operation by a child may result in impairment of bodily functions and harm health.

Do not let children play on or around the outdoor unit.

If they touch the unit carelessly, injury may be caused.

Consult your dealer regarding cleaning the inside of the air conditioner.

Improper cleaning may cause breakage of plastic parts, water leakage and other damage as well as electric shocks.

To avoid injury, do not touch the air inlet or aluminium fins of the unit.

Do not place objects in direct proximity of the outdoor unit and do not let leaves and other debris accumulate around the unit.

Leaves are a hotbed for small animals which can enter the unit. Once in the unit, such animals can cause malfunctions, smoke or fire when making contact with electrical parts.

Never touch the internal parts of the controller.

Do not remove the front panel. Touching certain internal parts will cause electric shocks and damage to the unit. Please consult your dealer about checking and adjustment of internal parts.

Do not leave the remote controller wherever there is a risk of wetting.

If water gets into the remote controller there is a risk of electrical leakage and damage to electronic components.

Watch your steps at the time of air filter cleaning or inspection.

High-place work is required, to which utmost attention must be paid.
If the scaffold is unstable, you may fall or topple down, thus causing injury.

3. OPERATION RANGE

If the temperature or the humidity is beyond the following conditions, safety devices may work and the air conditioner may not operate, or sometimes, water may drop from the indoor unit.

COOLING ONLY TYPE

| OUTDOOR UNIT | TEMPERATURE[°C] | |
|---|-----------------|-------------------------------|
| | OUTDOOR | INDOOR |
| R35-50-60GV1(A) | 19.4 to 46(DB) | 21 to 32(DB)/ 14 to 23(WB) |
| R71-100-125 FUV1/Y1 | 21 to 52(DB) | 21 to 35(DB)/ 14 to 25(WB) |
| R50-60GVAL | 19.4 to 54(DB) | 21 to 32(DB)/ 14 to 23(WB) |
| R71-100-125 FUVAL/TAL KUYAL | 21 to 50(DB) | 21 to 35(DB)/ 14 to 25(WB) |
| R71-100-125-140 KUV1/Y1 LUV1/Y1 | 21 to 46(DB) | 21 to 35(DB)/ 14 to 25(WB) |
| R71-100-125-140 KUVAL/TAL/YAL LUVAL/TAL/YAL | 21 to 46(DB) | 21 to 35(DB)/ 14 to 25(WB) |
| R125KUYALK | 21 to 54(DB) | 21 to 35(DB)/ 12 to 25(WB) |
| R140 KUTALK/YALK | 21 to 54(DB) | 21 to 35(DB)/ 12 to 25(WB) |

HEAT PUMP TYPE

| OUTDOOR UNIT | OPERATION | TEMPERATURE[°C] | |
|--------------|-----------|----------------------------------|-------------------------------|
| | | OUTDOOR | INDOOR |
| RY35FV1A | COOLING | 19.4 to 46(DB) | 21 to 32(DB)/ 14 to 23(WB) |
| | HEATING | -9 to 21(DB)/ -10 to 15.5(WB) | 15 to 28(DB) |
| RY50-60 GV1A | COOLING | 19.4 to 46(DB) | 21 to 32(DB)/ 14 to 23(WB) |
| | HEATING | -9 to 21(DB)/ -10 to 15(WB) | 14 to 28(DB) |

| | | | |
|----------------------------------|---------|----------------------------------|-------------------------------|
| RY71-100-125FUV1/Y1 | COOLING | -5 to 52(DB) | 21 to 35(DB)/ 14 to 25(WB) |
| | HEATING | -9 to 21(DB)/ -10 to 15.5(WB) | 15 to 27(DB) |
| RY50-60 GVAL | COOLING | 19.4 to 54(DB) | 21 to 32(DB)/ 14 to 23(WB) |
| | HEATING | -9 to 21(DB)/ -10 to 15(WB) | 14 to 28(DB) |
| RY71-100-125 FUVAL/TAL | COOLING | -5 to 50(DB) | 21 to 35(DB)/ 14 to 25(WB) |
| | HEATING | -9 to 21(DB)/ -10 to 15.5(WB) | 15 to 24(DB) |
| RY71-100-125-140 KUV1/Y1 LUV1/Y1 | COOLING | -5 to 46(DB) | 21 to 35(DB)/ 12 to 25(WB) |
| | HEATING | -9 to 21(DB)/ -10 to 15(WB) | 15 to 27(DB) |
| RY140 KUTAL/YAL LUTAL/YAL | COOLING | -5 to 46(DB) | 21 to 35(DB)/ 12 to 25(WB) |
| | HEATING | -9 to 21(DB)/ -10 to 15(WB) | 15 to 27(DB) |
| RY140 KUTALK/YALK | COOLING | -5 to 54(DB) | 21 to 35(DB)/ 12 to 25(WB) |
| | HEATING | -9 to 21(DB)/ -10 to 15(WB) | 15 to 27(DB) |

DB: Dry bulb temperature
WB: Wet bulb temperature

The setting temperature range of the remote controller is 16°C to 32°C.

4. INSTALLATION SITE

Regarding places for installation

- **Is the air conditioner installed at a well-ventilated place where there are no obstacles around?**
- **Do not use the air conditioner in the following places.**
 - a. Filled with much mineral oil such as cutting oil
 - b. Where there is much salt such as a beach area
 - c. Where sulfured gas exists such as a hot-spring resort
 - d. Where there are considerable voltage fluctuations such as a factory or plant
 - e. Vehicles and vessels
 - f. Where there is much spray of oil and vapor such as a cookery, etc.
 - g. Where there are machines generating electromagnetic waves
 - h. Filled with acid and/or alkaline steam or vapor
- **Is a snow protection measure taken?**
For details, consult your dealer.

Regarding wiring

- **All wiring must be performed by an authorized electrician.**
To do wiring, ask your dealer. Never do it by yourself.
- **Make sure that a separate power supply circuit is provided for this air conditioner and that all electrical work is carried out by qualified personnel according to local laws and regulations.**

Pay attention to running noises, too

- **Are the following places selected?**
 - a. A place that can sufficiently withstand the weight of the air conditioner with less running noises and vibrations.
 - b. A place where the hot wind discharged from the air outlet of the outdoor unit and the running noises.
- **Are you sure that there are no obstacles near the air outlet of the outdoor unit?**
Such obstacles may result in declined performance and increased running noises.
- **If abnormal noises occur in use, consult your dealer.**

Regarding drainage of drain piping









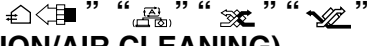
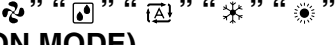

- **Is the drain piping executed to perform complete drainage?**
If proper drainage is not carried out from the outdoor drain pipes during air-conditioning operation, chances are that dust and dirt are clogged in the pipe. This may result in a water leakage from the indoor unit. Under such circumstances, stop the operation of the air conditioner, and then consult your dealer or our service station.

5. NAME AND FUNCTION OF EACH SWITCH AND DISPLAY ON THE REMOTE CONTROLLER

Refer to figure 1 on page [1]

The illustrations in this operating manual correspond to the remote control format BRC1C type. Although the display and shape of the buttons on the BRC1B type are slightly different, they may be operated in the same manner.

| | |
|---|--|
| 1 | ON/OFF BUTTON |
| | Press the button and the system will start. Press the button again and the system will stop. |
| 2 | OPERATION LAMP (RED) |
| | The lamp lights up during operation. |

| | |
|----|--|
| 3 | DISPLAY “” (UNDER CENTRALIZED CONTROL) |
| | When this display shows, the system is UNDER CENTRALIZED CONTROL. |
| 4 | DISPLAY “” (VENTILATION/AIR CLEANING) |
| | This display shows that the total heat exchange and the air cleaning unit are in operation (These are optional accessories). |
| 5 | DISPLAY “” (OPERATION MODE) |
| | This display shows the current OPERATION MODE. For cooling only type, “  ” (Auto) and “  ” (Heating) are not installed. |
| 6 | DISPLAY “ TEST” (INSPECTION/TEST OPERATION) |
| | When the INSPECTION/TEST OPERATION BUTTON is pressed, the display shows the system mode is in. |
| 7 | DISPLAY “” (PROGRAMMED TIME) |
| | This display shows the PROGRAMMED TIME of the system start or stop. |
| 8 | DISPLAY “” (SET TEMPERATURE) |
| | This display shows the set temperature. |
| 9 | DISPLAY “” (FAN SPEED) |
| | This display shows the set fan speed. |
| 10 | DISPLAY “” (AIR FLOW FLAP) |
| | Refer to “ADJUSTING THE AIR FLOW DIRECTION”. |
| 11 | DISPLAY “” (TIME TO CLEAN AIR FILTER) |
| | Refer to “HOW TO CLEAN THE AIR FILTER”. |
| 12 | DISPLAY “” (DEFROST) |
| | Refer to “DEFROST OPERATION”. |
| 13 | NON-FUNCTIONING DISPLAY |
| | If that particular function is not available, pressing the button may display the words “NOT AVAILABLE” for a few seconds. When running multiple units simultaneously The “NOT AVAILABLE” message will only be appear if none of the indoor units is equipped with the function. If even one unit is equipped with the function, the display will not appear. |
| 14 | TIMER MODE START/STOP BUTTON |
| | Refer to “PROGRAM TIMER OPERATION”. |
| 15 | TIMER ON/OFF BUTTON |
| | Refer to “PROGRAM TIMER OPERATION”. |
| 16 | INSPECTION/TEST OPERATION BUTTON |
| | This button is used only by qualified service persons for maintenance purposes. |

| | |
|--|--|
| 17 | PROGRAMMING TIME BUTTON Use this button for programming "START and/or STOP" time. |
| 18 | TEMPERATURE SETTING BUTTON Use this button for SETTING TEMPERATURE. |
| 19 | FILTER SIGN RESET BUTTON Refer to "HOW TO CLEAN THE AIR FILTER". |
| 20 | FAN SPEED CONTROL BUTTON Press this button to select the fan speed, HIGH or LOW, of your choice. |
| 21 | OPERATION MODE SELECTOR BUTTON Press this button to select OPERATION MODE. |
| 22 | AIR FLOW DIRECTION ADJUST BUTTON Refer to "ADJUSTING THE AIR FLOW DIRECTION". |
| NOTE | |
| <ul style="list-style-type: none"> For the sake of explanation, all indications are shown on the display in figure 1 contrary to actual running situations. | |

6. OPERATION PROCEDURE

Refer to figure 1 on page [1]

- Operating procedure varies with heat pump type and cooling only type. Contact your Daikin dealer to confirm your system type.
- To protect the unit, turn on the main power switch 12 hours before operation.
- If the main power supply is turned off during operation, operation will restart automatically after the power turns back on again.

COOLING, HEATING, AUTOMATIC, FAN, AND PROGRAM DRY OPERATION

Operate in the following order.

1 OPERATION MODE SELECTOR

Press **OPERATION MODE SELECTOR** button several times and select the **OPERATION MODE** of your choice as follows.

- **COOLING OPERATION** " "
- **HEATING OPERATION** " "
- **AUTOMATIC OPERATION** " "
 - In this operation mode, COOL/HEAT changeover is automatically conducted.
- **FAN OPERATION** " "

- **DRY OPERATION** " "
 - The function of this program is to decrease the humidity in your room with the minimum temperature decrease.
 - Micro computer automatically determines TEMPERATURE and FAN SPEED.
 - This system does not go into operation if the room temperature is below 16°C.

Refer to figure 3 on page [1]

- For cooling only type, "COOLING", "FAN" and "DRY" operation are able to select.

2 ON/OFF

Press **ON/OFF** button

OPERATION lamp lights up or goes off and the system starts or stops OPERATION.

[EXPLANATION OF HEATING OPERATION]

DEFROST OPERATION

- As the frost on the coil of an outdoor unit increase, heating effect decreases and the system goes into DEFROST OPERATION.
- The indoor unit fan stops and the remote controller display shows " ".
- After 6 to 8 minutes (maximum 10 minutes) of DEFROST OPERATION, the system returns to HEATING OPERATION.

Regarding outside air temperature and heating capacity

- The heating capacity of the air conditioner declines as the outside air temperature falls. In such a case, use the air conditioner in combination with other heating systems.
- A warm air circulating system is employed, and therefore it takes some time until the entire room is warmed up after the start of operation.
- An indoor fan runs to discharge a gentle wind automatically until the temperature inside the air conditioner reaches a certain level. At this time, the remote controller displays " ". Leave it as it stands and wait for a while.
- When the warm air stays under the ceiling and your feet are cold, we recommend that you use a circulator (a fan to circulate the air inside the room). For details, consult your dealer.

ADJUSTMENT

For programming TEMPERATURE, FAN SPEED and AIR FLOW DIRECTION, follow the procedure shown below.



TEMPERATURE SETTING

Press **TEMPERATURE SETTING** button and program the setting temperature.

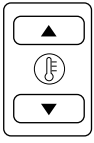

Each time this button is pressed, setting temperature rises 1°C.

Each time this button is pressed, setting temperature lowers 1°C.

- The setting is impossible for fan operation.

NOTE

- The setting temperature range of the remote controller is 16°C to 32°C.



FAN SPEED CONTROL

Press **FAN SPEED CONTROL** button.

High or Low fan speed can be selected.

The microchip may sometimes control the fan speed in order to protect the unit.



AIR FLOW DIRECTION ADJUST

Press the **AIR FLOW DIRECTION** button to adjust the air flow angle.

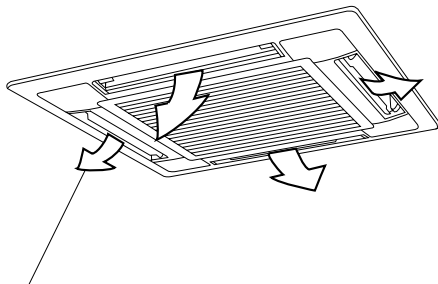

Up and down adjustment

- The movable limit of the flap is changeable. Contact your Daikin dealer for details.

Press the **AIR FLOW DIRECTION ADJUST** button to select the air direction as shown below.

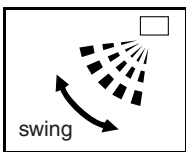

The **AIR FLOW FLAP** display swings as shown below and the air flow direction continuously varies. (Automatic swing setting)



Press **AIR FLOW DIRECTION ADJUST** button to select the air direction of your choice.

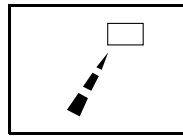

The **AIR FLOW FLAP** display stops swinging and the air flow direction is fixed (Fixed air flow direction setting).

MOVEMENT OF THE AIR FLOW FLAP

For the following conditions, micro computer controls the air flow direction so it may be different from the display.

| Operation mode | Cooling | Heating |
|---------------------|---|--|
| Operation condition | <ul style="list-style-type: none"> • When room temperature is lower than the set temperature • When operating continuously at horizontal air flow direction | <ul style="list-style-type: none"> • When room temperature is higher than the set temperature • At defrost operation |

Operation mode includes automatic operation.

PROGRAM TIMER OPERATION

Operate in the following order.

- The timer is operated in the following two ways.
- Programming the stop time (⊕ · ○) The system stops operating after the set time has elapsed.
- Programming the start time (⊕ · |) The system starts operating after the set time has elapsed.
- The timer can be programmed a maximum of 72 hours.
- The start and the stop time can be simultaneously programmed.

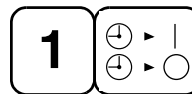

TIMER MODE START/STOP

Press the **TIMER MODE START/STOP** button several times and select the mode on the display.

The display flashes.

For setting the timer stop “⊕ · ○”

For setting the timer start “⊕ · |”



PROGRAMMING TIME

Press the **PROGRAMMING TIME** button and set the time for stopping or starting the system.

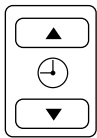

When this button is pressed, the time advances by 1 hour.



When this button is pressed, the time goes backward by 1 hour.

3



TIMER ON/OFF

Press the **TIMER ON/OFF** button.

The timer setting procedure ends.

The display “ ⊕ · ○ or ⊕ · | ” changes from flashing light to a constant light.

Refer to figure 4 on page [1]

NOTE

- When setting the timer Off and On at the same time, repeat the above procedure from 1 to 3 once again.

When the timer is programmed to stop the system after 3 hours and start the system after 4 hours, the system will stop after 3 hours and then 1 hour later the system will start.

- After the timer is programmed, the display shows the remaining time.
- Press the **TIMER ON/OFF** button once again to cancel programming. The display vanishes.

7. OPTIMUM OPERATION

Observe the following precautions to ensure the system operates.

- Adjust the room temperature properly for a comfortable environment. Avoid excessive heating or cooling.
- Prevent direct sunlight from entering a room during cooling operation by using curtains or blinds.
- Ventilate the room regularly.
Using the unit for long periods of time requires attentive ventilation of the room.
- Keep doors and windows closed. If the doors and windows remain open, room air will flow out and cause to decrease the effect of cooling and heating.
- Do not place other heaters directly below the indoor unit.
They may deform due to the heat.
- Never place objects near the air inlet and the air outlet of the unit. It may cause deterioration in the effect or stop in the operation.

- Turn off the main power supply switch when it is not used for long periods of time. When the main power switch is turned on, some watts of electricity is being used even if the system is not operating. Turn off the main power supply switch for saving energy. When reoperating, turn on the main power supply switch 6hours before operation for smooth running (Refer to MAINTENANCE).
- When the display shows “ ” (TIME TO CLEAN AIR FILTER), ask a qualified service person to clean the filters (Refer to MAINTENANCE).
- Fully use the function of air flow direction adjust. Cold air gathers on the floor, and warm air gathers in the ceiling.
Set the air flow direction parallel during cooling or dry operation, and set it downwards during heating operation.
Do not let the air blow directly to a person.
- It takes time for the room temperature to reach the set temperature.
We recommend starting the operation in advance using timer operation.

8. MAINTENANCE (FOR SERVICE PERSONNEL)

ONLY A QUALIFIED SERVICE PERSON IS ALLOWED TO PERFORM MAINTENANCE

IMPORTANT!

- **BEFORE OBTAINING ACCESS TO TERMINAL DEVICES, ALL POWER SUPPLY CIRCUITS MUST BE INTERRUPTED**
- To clean the air conditioner, be sure to stop operation, and turn the power switch off. Otherwise, an electric shock and injury may result.
- Do not wash the air conditioner with water
Doing so may result in an electric shock.
- Be careful with a scaffold or staging
Caution must be exercised because of work at a high place.

HOW TO CLEAN THE AIR FILTER

Clean the air filter when the display shows “ ” (TIME TO CLEAN AIR FILTER).

Increase the frequency of cleaning if the unit is installed in a room where the air is extremely contaminated.

If the dirt becomes impossible to clean, change the air filter. (Air filter for exchange is optional)

1. Open the suction grille.

Pull it downward slowly while pressing the buttons provided on two spots.

(Do the same procedure for closing.)

Fig. 1

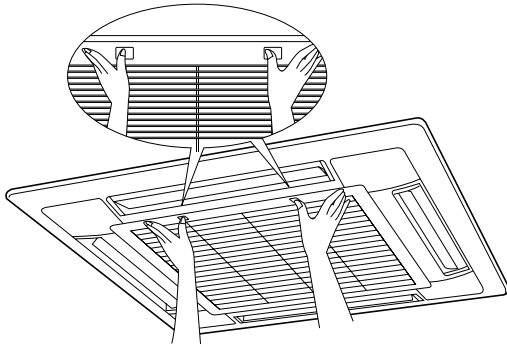

2. Remove the air filters.

Pull the hook of the air filter out diagonally downward, and remove the filter.

Fig. 2

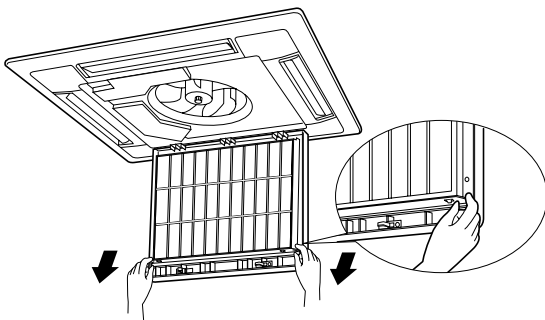

3. Clean the air filter.

Use vacuum cleaner **A)** or wash the air filter with water **B)**.

A) Using a vacuum cleaner



B) Washing with water

When the air filter is very dirty, use soft brush and neutral detergent.



Remove water and dry in the shade.

4. Fix the air filter.

(1) Hook the air filter to a protrusion on the suction grille.

(2) Push the lower part of the air filter onto the protrusion at the lower part of the suction grille, and fix the air filter there.

Fig. 3

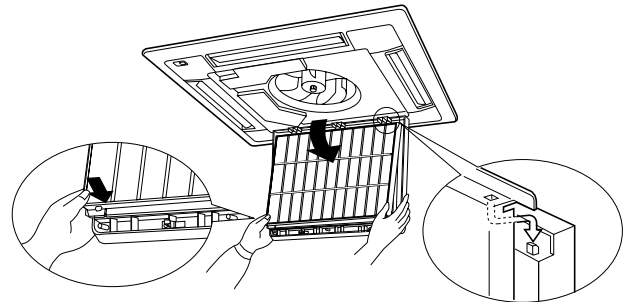

5. Shut the suction grille.

Refer to item No. 1.

6. After turning on the power, press **FILTER SIGN RESET** button.

The "TIME TO CLEAN AIR FILTER" display vanishes.

HOW TO CLEAN AIR OUTLET AND OUTSIDE PANELS

- Clean with soft cloth
- When it is difficult to remove stains, use water or neutral detergent.
- When the flap is extremely contaminated, remove it as below and clean or exchange it.
(Flap for exchange is optional)

NOTE

- Do not use gasoline, benzene, thinner, polishing powder, liquid insecticide. It may cause discoloring or warping.
- Do not let the indoor unit get wet. It may cause an electric shock or a fire.
- Do not scrub firmly when washing the blade with water.
The surface sealing may peel off.
- Do not use water or air of 50°C or higher for cleaning air filters and outside panels.

NOTE

- Do not wash the air conditioner with hot water of more than 50°C, as doing so may result in discoloration and/or deformation.
- Do not expose it to fire, as doing so may result in burning.

HOW TO CLEAN THE SUCTION GRILLE

1. Open the suction grille.

Push it downward slowly while pressing the buttons provided on two spots. (Follow the same procedure for closing.)

Fig. 4

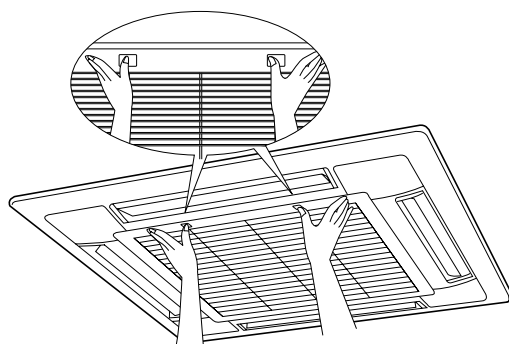

2. Detach the suction grille.

Open the suction grille 45 degrees and lift it upward.

Fig. 5

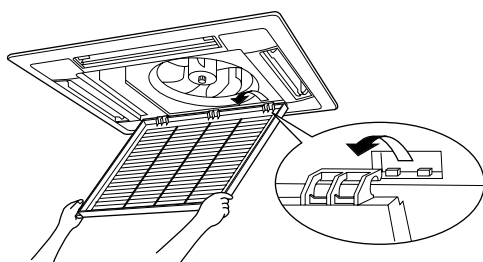

3. Detach the air filter.

Refer to "HOW TO CLEAN THE AIR FILTER". (Refer to Fig. 2)

4. Clean the suction grille.

Wash with a soft bristle brush and neutral detergent or water, and dry thoroughly.



5. Reattach the air filter.

Refer to "HOW TO CLEAN THE AIR FILTER" (Refer to Fig. 3)

6. Reattach the suction grille.

Refer to item No. 2.

7. Close the suction grille.

Refer to item No. 1.

START UP AFTER A LONG STOP

Confirm the following

- Check that the air inlet and outlet are not blocked. Remove any obstacle.

- Check if the earth is connected. Might there be a broken wire somewhere? Contact your dealer if there are any problems.

Clean the air filter and outside panels

- After cleaning the air filter, make sure to attach it.

Turn on the main power supply switch

- The display on the remote controller will be shown when the power is turned on.
- To protect the unit, turn on the main power switch at least 6 hours before operation.

WHAT TO DO WHEN STOPPING THE SYSTEM FOR A LONG PERIOD

Turn on FAN OPERATION for a half day and dry the unit.

- Refer to "FAN OPERATION".

Cut off the power supply.

- When the main power switch is turned on, some watts of electricity is being used even if the system is not operating. Turn off the main power supply switch for saving energy.
- The display on the remote controller will vanish when the main power switch is turned off.

Clean the air filter and the exterior.

- Be sure to replace the air filter to its original place after cleaning. Refer to "MAINTENANCE".

9. NOT MALFUNCTION OF THE AIR CONDITIONER

The following symptoms do not indicate air conditioner malfunction

I. THE SYSTEM DOES NOT OPERATE

- **The system does not restart immediately after the ON/OFF button is pressed.**

If the OPERATION lamp lights, the system is in normal condition.

It does not restart immediately because a safety device operates to prevent overload of the system. After 3 minutes, the system will turn on again automatically.

- **The system does not restart immediately when TEMPERATURE SETTING button is returned to the former position after pushing the button.**

If the OPERATION lamp lights, the system is in normal condition.

It does not restart immediately because a safety device operates to prevent overload of the system. After 3 minutes, the system will turn on again automatically.

- **The system does not start when the display shows “” (UNDER CENTRALIZED CONTROL) and it flashes for few seconds after pressing an operation button.**
This is because the system is under centralized control. Flashes on the display indicates that the system cannot be controlled by the remote controller.
- **The system does not start immediately after the power supply is turned on.**
Wait one minute until the micro computer is prepared for operation.

II. WHITE MIST COMES OUT OF A UNIT

- **When humidity is high during cooling operation. (In oily or dusty places)**
If the inside of an indoor unit is extremely contaminated, the temperature distribution inside a room becomes uneven. It is necessary to clean the inside of the indoor unit. Ask your Daikin dealer for details on cleaning the unit. This operation requires a qualified service person.
- **When the system is changed over to HEATING OPERATION after DEFROST OPERATION.**
Moisture generated by DEFROST becomes steam and exists.

III. NOISE OF AIR CONDITIONERS

- **A ringing sound after the unit is started.**
This sound is generated by the temperature regulator working.
It will quiet down after about a minute.
- **A continuous flow “Shuh” sound is heard when the systems is in COOLING or DEFROST OPERATION.**
This is the sound of refrigerant gas flowing through both indoor and outdoor units.
- **A “Shuh” sound which is heard at the start or immediately after the stop of operation or which is heard at the start or immediately after the stop of DEFROST OPERATION.**
This is the noise of refrigerant caused by flow stop and flow change.
- **A continuous low “Shah” sound is heard when the system is in COOLING OPERATION or at a stop.**
The noise is heard when the drain pump is in operation.
- **A “Pishi-pishi” squeaking sound is heard when the system is in operation or after the stop of operation.**
Expansion and contraction of plastic parts caused by temperature change makes this noise.

IV. DUST FROM THE UNITS

- **Dust may blow out from the unit after starting operation from long resting time.**
Dust absorbed by the unit blows out.

V. THE UNITS GIVE OFF ODORS

The unit absorbs the smell of rooms, furniture, cigarettes, etc., and then emits them.

VI. THE LIQUID CRYSTAL OF THE REMOTE CONTROLLER SHOW “”

- **It happens immediately after the main power supply switch is turned on.**
This shows that the remote controller is in normal condition.
This continues temporary.

10. TROUBLE SHOOTING

- If one of the following malfunctions occurs, take the measures shown below and contact your Daikin dealer.**

The system must be repaired by a qualified service person.

WARNING

When the air conditioner is in abnormal conditions (smell of something burning, etc), unplug the power cord from the outlet, and contact your dealer

Continued operation under such circumstances may result in a failure, electric shock, and fire.

- If a safety device such as a fuse, a breaker or an earth leakage breaker frequently actuates;
Measure: Do not turn on the main power switch.
- If the ON/OFF switch does not properly work;
Measure: Turn off the main power switch.
- If water leaks from unit.
Measure: Stop the operation.
- If the display “” (INSPECTION), “UNIT No.”, and the OPERATION lamp flash and the “MALFUNCTION CODE” appears.

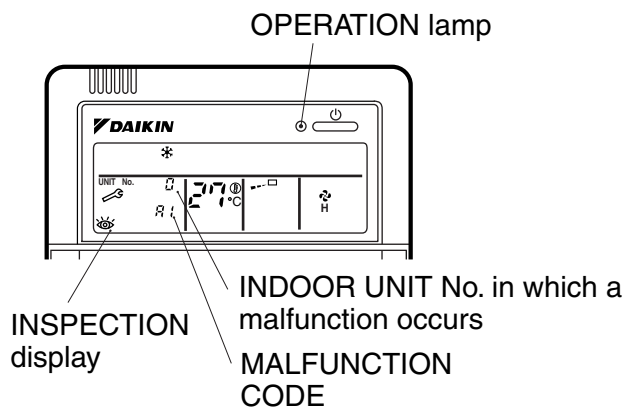

Measure: Notify your Daikin dealer and inform him/her of the display.

II. If the system does not properly operate except for the above mentioned case, and none of the above mentioned malfunctions is evident, investigate the system according to the following procedures.

1. If the system does not operate at all.

- Check if there is a power failure.
Wait until power is restored. If power failure occurs during operation, the system automatically restarts immediately after the power supply recovers.
- Check if no fuse has blown.
Turn off the power supply.
- Check if the breaker is blown.
Turn the power on with the breaker switch in the off position.
Do not turn the power on with the breaker switch in the trip position.
(Contact your dealer.)

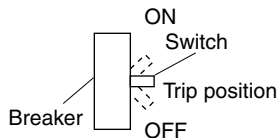

2. If the system stops operating after operating the system.

- Check if the air inlet or outlet of outdoor or indoor unit is blocked by obstacles.
Remove the obstacle and make it well-ventilated.
- Check if the air filter is clogged.
Ask a qualified service person to clean the air filters (Refer to MAINTENANCE).

3. The system operates but it does not sufficiently cool or heat.

- If the air inlet or outlet of the indoor or the outdoor unit is blocked with obstacles.
Remove the obstacle and make it well-ventilated.
- If the air filter is clogged.
Ask a qualified service person to clean the air filters (Refer to MAINTENANCE).
- If the set temperature is not proper (Refer to ADJUSTMENT).
- If the FAN SPEED button is set to LOW SPEED (Refer to ADJUSTMENT).
- If the air flow angle is not proper (Refer to ADJUSTING THE AIR FLOW DIRECTION).
- If the doors or the windows are open. Shut doors or windows to prevent wind from coming in.
- If direct sunlight enters the room (when cooling).
Use curtains or blinds.

- When there are too many inhabitants in the room (when cooling).
Cooling effect decreases if heat gain of the room is too large.
- If the heat source of the room is excessive (when cooling).
Cooling effect decreases if heat gain of the room is too large.

11. SPECIFICATIONS

(These specifications are in compliance with SASO 385, 386.)

| | | | | | | | | | | |
|----------------------------|-------------------|---|---|---|---|---|-------------------------------------|-------------------------------------|-------------------------------------|-------------------------------------|
| INDOOR UNIT | FHC50KVE | FHC60KVE | FHC71KVE | FHC100KVE | FHC125KVE | FHC140KVE | FHC140KVE | FHC125KVE | FHC140KVE | FHC140KVE |
| OUTDOOR UNIT | R50GVAL | R60GVAL | R71FUVAL | R100FUVAL | R125FUTAL | R140KTAL | R140KUTALK | R125KUYALK | R140KUTALK | R140KUYALK |
| RATED VOLTAGE | V | 220 | 220 | 220 | 220 | 220 | 220 | 380 | 220 | 380 |
| RATED FREQUENCY | Hz | 60 | 60 | 60 | 60 | 60 | 60 | 60 | 60 | 60 |
| COOLING POWER INPUT RATING | kW | 2.5 | 3.14 | 4.2 | 5.8 | 6.8 | 6.8 | 6.8 | 6.8 | 7.1 |
| CURRENT INPUT RATING | A | 11.8 | 15.2 | 20.0 | 27.4 | 19.8 | 19.8 | 11.3 | 19.8 | 12.3 |
| CAPACITY | kW | 4.5 | 5.6 | 6.7 | 9.0 | 14.0 | 14.0 | 12.5 | 14.0 | 14.0 |
| | kcal/h | 3900 | 4800 | 5800 | 7700 | 12000 | 12000 | 10800 | 12000 | 12000 |
| HEATING POWER INPUT RATING | kW | - | - | - | - | - | - | - | - | - |
| CURRENT INPUT RATING | A | - | - | - | - | - | - | - | - | - |
| CAPACITY | kW | - | - | - | - | - | - | - | - | - |
| | kcal/h | - | - | - | - | - | - | - | - | - |
| WEIGHT OF INDOOR UNIT | kg | 24 | 24 | 24 | 28 | 28 | 28 | 28 | 28 | 28 |
| WEIGHT OF OUTDOOR UNIT | kg | 41 | 51 | 87 | 117 | 109 | 109 | 109 | 109 | 109 |
| REFRIGERANT | | R22 | R22 | R22 | R22 | R22 | R22 | R22 | R22 | R22 |
| MASS OF REFRIGERANT CHARGE | kg | 1.15 | 1.60 | 2.2 | 2.9 | 4.3 | 2.7(Charged for 5m) | 2.7(Charged for 5m) | 2.7(Charged for 5m) | 2.7(Charged for 5m) |
| INDOOR UNIT | FHYC50KVE | FHYC60KVE | FHYC71KVE | FHYC100KVE | FHYC125KVE | FHYC140KVE | FHYC140KVE | FHYC140KVE | FHYC140KVE | FHYC140KVE |
| OUTDOOR UNIT | RY50GVAL | RY60GVAL | RY71FUVAL | RY100FUVAL | RY125FUTAL | RY140KTAL | RY140KUTALK | RY140KUYALK | RY140KUTALK | RY140KUYALK |
| RATED VOLTAGE | V | 220 | 220 | 220 | 220 | 220 | 220 | 380 | 220 | 380 |
| RATED FREQUENCY | Hz | 60 | 60 | 60 | 60 | 60 | 60 | 60 | 60 | 60 |
| COOLING POWER INPUT RATING | kW | 2.34 | 3.06 | 4.3 | 5.9 | 6.6 | 6.9 | 7.3 | 6.9 | 7.3 |
| CURRENT INPUT RATING | A | 11.4 | 14.8 | 20.3 | 27.6 | 18.1 | 20.1 | 12.6 | 20.1 | 12.6 |
| CAPACITY | kW | 5.0 | 5.6 | 6.7 | 9.0 | 12.5 | 14.0 | 14.0 | 14.0 | 14.0 |
| | kcal/h | 4300 | 4820 | 5800 | 7700 | 10800 | 12000 | 12000 | 12000 | 12000 |
| HEATING POWER INPUT RATING | kW | 1.85 | 2.44 | 3.8 | 5.0 | 5.42 | 5.7 | 5.7 | 5.7 | 5.7 |
| CURRENT INPUT RATING | A | 9.0 | 11.8 | 18.0 | 23.5 | 14.9 | 16.6 | 9.9 | 16.6 | 9.9 |
| CAPACITY | kW | 6.0 | 7.1 | 8.5 | 11.98 | 15.0 | 17.0 | 17.0 | 17.0 | 17.0 |
| | kcal/h | 5200 | 6110 | 7300 | 10100 | 12900 | 14600 | 14600 | 14600 | 14600 |
| WEIGHT OF INDOOR UNIT | kg | 24 | 24 | 24 | 28 | 28 | 28 | 28 | 28 | 28 |
| WEIGHT OF OUTDOOR UNIT | kg | 50 | 62 | 91 | 120 | 114 | 112 | 112 | 112 | 112 |
| REFRIGERANT | | R22 | R22 | R22 | R22 | R22 | R22 | R22 | R22 | R22 |
| MASS OF REFRIGERANT CHARGE | kg | 1.45 | 1.75 | 2.3 | 2.6 | 4.3 | 2.7(Charged for 5m) | 2.7(Charged for 5m) | 2.7(Charged for 5m) | 2.7(Charged for 5m) |
| COUNTRY OF ORIGIN | indoor outdoor | JAPAN or THAILAND THAILAND | JAPAN or THAILAND THAILAND | JAPAN or THAILAND THAILAND | JAPAN or THAILAND THAILAND | THAILAND | THAILAND | THAILAND | THAILAND | THAILAND |
| MANUFACTURER'S NAME | indoor outdoor | DAIKIN INDUSTRIES,LTD. or DAIKIN INDUSTRIES (THAILAND)LTD. | DAIKIN INDUSTRIES,LTD. or DAIKIN INDUSTRIES (THAILAND)LTD. | DAIKIN INDUSTRIES,LTD. or DAIKIN INDUSTRIES (THAILAND)LTD. | DAIKIN INDUSTRIES,LTD. or DAIKIN INDUSTRIES (THAILAND)LTD. | DAIKIN INDUSTRIES,LTD. or DAIKIN INDUSTRIES (THAILAND)LTD. | DAIKIN INDUSTRIES (THAILAND)LTD. | DAIKIN INDUSTRIES (THAILAND)LTD. | DAIKIN INDUSTRIES (THAILAND)LTD. | DAIKIN INDUSTRIES (THAILAND)LTD. |

DAIKIN INDUSTRIES, LTD.

Head office:

Umeda Center Bldg., 2-4-12, Nakazaki-Nishi,
Kita-ku, Osaka, 530-8323 Japan

Tokyo office:

JR Shinagawa East Bldg., 2-18-1, Konan,
Minato-ku, Tokyo, 108-0075 Japan

大金工業株式会社

總公司

日本大阪府大阪市北區中崎西二丁目4番12號
梅田中心大廈 郵遞區號 530-8323

東京分公司

日本東京都港區港南二丁目18番1號
JR品川東大廈 郵遞區號108-0075

大金工業株式会社

总公司

日本大阪府大阪市北區中崎西二丁目4番12号
梅田中心大廈 郵政編碼 530-8323

东京分公司

日本東京都港區港南二丁目18番1号
JR品川東大廈 郵政編碼108-0075

شركة دايكن للصناعات المحدودة

المكتب الرئيسي:

بنية أوميدا سنتر، ٤-١٢ ناكازاكي نيشي ٢-تشوميه،
كيتا - كو، أوساكا، ٥٣٠-٨٣٢٣ اليابان

مكتب طوكيو:

مبنى شيناغاوا الشرقي لخطوط سكة الحديد اليابانية (JR)، رقم ١٨-١، كونان
٢-تشومى، ميناتو-كو، طوكيو، ١٠٨-٠٠٧٥ اليابان