

AIR COOLED PACKAGED AIR CONDITIONERS

FLOOR STANDING TYPE
DUCT TYPE

COOLING ONLY 50Hz
HEAT PUMP 50Hz

R-22

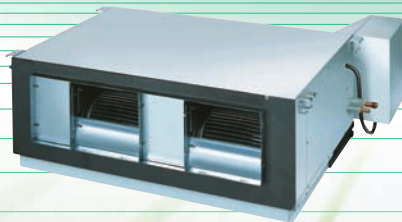

DUCT TYPE



FLOOR STANDING TYPE

DIRECT AIR BLOW TYPE

DUCT CONNECTION TYPE









*Suitable for
factories*

Comfort in wide spaces















A floor standing air conditioner with large air flow that is suitable for wide spaces. Merits include long refrigerant piping for great freedom of installation .

Product Line Up R-22

FLOOR STANDING TYPE Cooling only

		HP	5	6	8	10
Capacity ^{1,3}	kW		14.7	17.6	23.5	29.3
	Btu/h		50,000	60,000	80,000	100,000
	kcal/h		12,600	15,100	20,200	25,200
FLOOR STANDING TYPE	DIRECT AIR BLOW TYPE					
	Indoor unit Outdoor unit		FVG05BV1 RU05NY1	FVG06BV1 RU06NY1	FVG08BV1 RU08NY1	FVG10BV1 RU10NY1
FLOOR STANDING TYPE	DUCT CONNECTION TYPE					
	Indoor unit Outdoor unit					FVPG10BY1 RU10NY1
OUTDOOR UNIT						

DUCT TYPE Cooling only Heat pump

		HP	5	6	8	10
Capacity ^{1,3}	kW		14.7	17.6	23.5	29.3
	Btu/h		50,000	60,000	80,000	100,000
	kcal/h		12,600	15,100	20,200	25,200
DUCT TYPE Cooling only						
	Indoor unit Outdoor unit		FD05KAY1 RU05NY1	FD06KAY1 RU06NY1	FD08KAY1 RU08NY1	FD10KAY1 RU10NY1
Capacity ^{2,3} (Cooling /Heating)	kW			14.5/15.3	22.5/23.1	27.6/29.4
	Btu/h			49,500/52,200	76,800/78,800	94,200/100,300
	kcal/h			12,500/13,200	19,300/19,900	23,700/25,300
DUCT TYPE Heat pump						
	Indoor unit Outdoor unit			FDY06KAY1 RY140LUY1	FDY08KAY1 RY200KUY1	FDY10KAY1 RY250KUY1
OUTDOOR UNIT				 	 	 

Note : ¹Rated cooling capacities are based on the following conditions: Return air temp., 27°CDB, 19.5°CWB; outdoor temp. 35°CDB. Equiv. refrigeration piping, 5 m (horizontal).
²Rated heating capacities are based on the following conditions: Return air temp., 20°CDB; outdoor temp., 7°CDB, 6°CWB. Equiv. refrigeration piping, 5 m (horizontal).
³Capacity includes indoor fan motor heat.

DIRECT AIR BLOW TYPE

Direct air blow from indoor unit with plenum

- Comfortable factory air conditioning using multiple indoor units installed in accordance with the space.
- Installation is next to walls, so units will not affect the factory layout even if the changes are made.

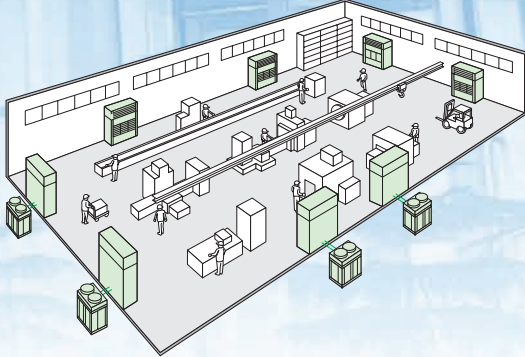

DUCT CONNECTION TYPE

DUCT TYPE







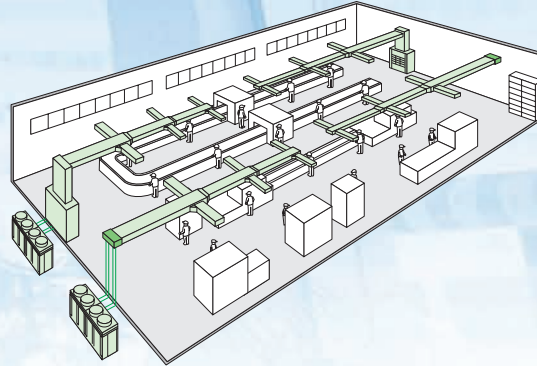

Air blow via connected ducts

- Comfortable air conditioning of the entire factory by connecting a blow duct at the top of the indoor unit.

Note: Ducts to be procured locally.















50Hz

	13	15	18	20
	35.2	46.9	52.8	58.6
	120,000	160,000	180,000	200,000
	30,200	40,300	45,400	50,400
NEW		NEW 	NEW 	NEW 
	FVPG13BY1 RU13NY1	FVPG15BY1 RU15NY1	FVPG18BY1 RU18NY1	FVPG20BY1 RU20NY1
NEW		NEW 	NEW 	NEW 

Nice,
cool air in the factory
or in the cafeteria



50Hz

	13	15	18	20
	35.2	46.9	52.8	58.6
	120,000	160,000	180,000	200,000
	30,200	40,300	45,400	50,400
NEW		NEW 	NEW 	NEW 
	FD13KAY1 RU13NY1	FD15KAY1 RU15NY1	FD18KAY1 RU18NY1	FD20KAY1 RU20NY1
		44.0/44.6		53.9/56.6
		150,000/152,000 37,800/38,400		184,000/193,000 46,400/48,700
				
		FDY15KAY1 RY200KUY1 x 2		FDY20KAY1 RY250KUY1 x 2
NEW		NEW  	NEW 	NEW  



NEW Indicates new capacity model. **NEW** Indicates new design model.

■ FLOOR STANDING TYPE

DIRECT AIR BLOW TYPE



FVG10BV1



RU10NY1

DUCT CONNECTION TYPE



FVPG10BY1



RU10NY1

Rounded design of indoor unit



■ DUCT TYPE

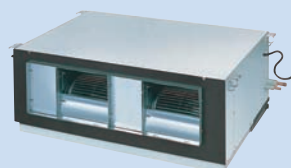

FD10KAY1



RU10NY1

Easy installation

Easy installation

Designed for long refrigerant piping.

50 m maximum length and 30 m maximum level difference to cover medium- and large-scale building needs.

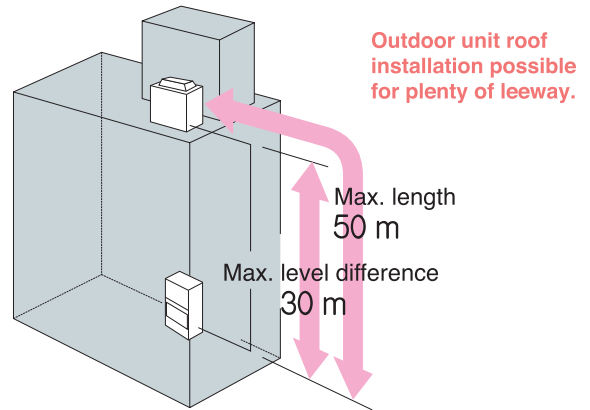

Refrigerant pre charged for up to 7.5 metres

All models are factory shipped with refrigerant charged for 7.5 metres of piping. (Applies to RU05N-20N)

■ Allowable refrigerant pipe length and level difference

	Pre-charged ¹	Max. length	Max. level difference
RU05NY1 RU13NY1 RU06NY1 RU15NY1 RU08NY1 RU18NY1 RU10NY1 RU20NY1	7.5 m	50 m (Equivalent length 70 m)	30 m

Note: ¹Additional refrigerant charging is required if the refrigerant pipe is longer than the indicated length.

4-direction piping affords more freedom of layout (Applies to RU05N/06N)

Piping can be run from the front, bottom, right or rear surface according to how the unit is installed.

In case of RU08-20N piping can be drawn out in two directions-front, and under side.

RU10-20N models can be combined for centralized, horizontal-series installation

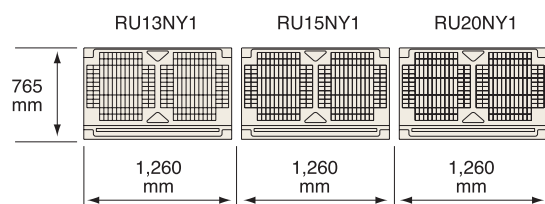

on and great reliability.

Cooling only

Quiet Operation

Equipped with scroll compressor for quiet operation.

Smooth running, low vibration, low operating sound.

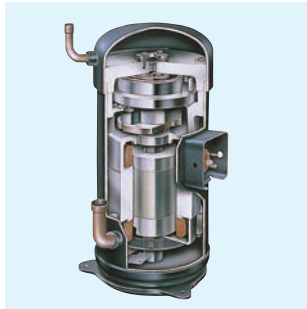

Outdoor unit	Sound level	
	380V	415V
RU05NY1	59 dB	60 dB
RU06NY1	59 dB	60 dB

Easy operation

Digital remote control comes standard with indoor unit.

Temperature setting is possible by button operation. The set temperature is conveniently displayed on the LED.

Floor standing type (Standard accessory)

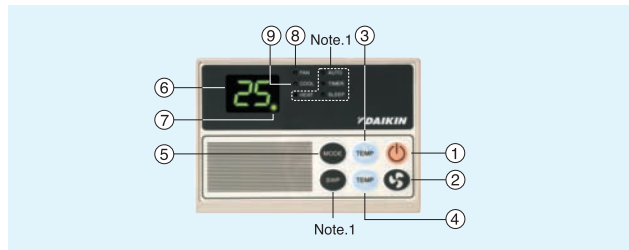

- ① On/Off button
- ② Fan button
- ③ Temp. setting up
- ④ Temp. setting down
- ⑤ Mode button
- ⑥ LED display
- ⑦ Compressor operation lamp.
- ⑧ Fan operation lamp.
- ⑨ Cool operation lamp.

Note. 1 It cannot be used for FVPG10-20BY1

Duct type (optional accessory)

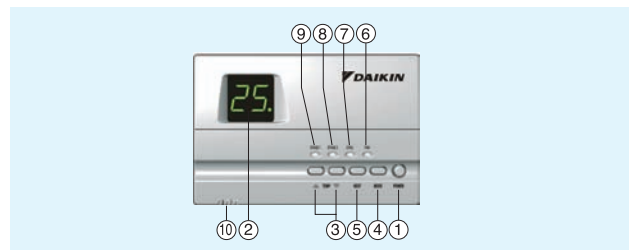

- ① Power
- ② Temperature scale
- ③ Temperature setting
- ④ Mode setting
- ⑤ Next setting
- ⑥ Fan indicator lamp
- ⑦ Cool indicator lamp
- ⑧ Compressor 2 indicator lamp
- ⑨ Compressor 1 indicator lamp
- ⑩ Temperature sensor

Modification possible

The fan motor and pulley can be changed in accordance with the static pressure required at a particular site.

(Applies to Duct connection type)

Durability

Heat exchange fins provided with anti-corrosion treatment.

(Applies to all outdoor units)

To achieve increased durability by improved resistance to salt corrosion and atmospheric pollution, coated PE fins (with special acryl pretreatment) are used for the heat exchanger of the outdoor unit.

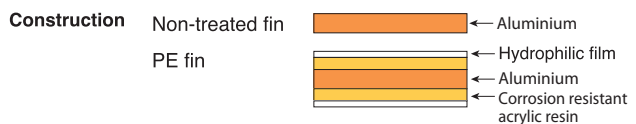

Space savings

Installation space is saved thanks to a more compact outdoor unit. This also makes it easier to install.

53%
space saved compared to previous model

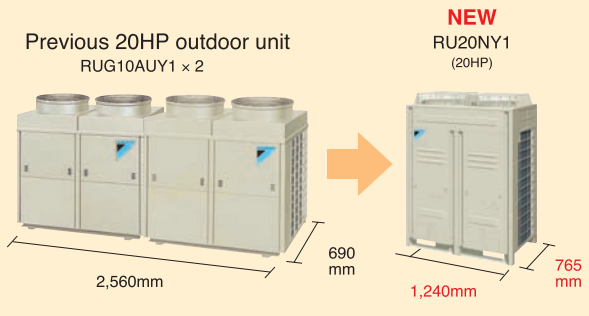

SPECIFICATIONS

■ FLOOR STANDING TYPE Cooling only DIRECT AIR BLOW TYPE

Model Name		Indoor unit		5HP	6HP	8HP	10HP
		Outdoor unit		FVG05BV1 RU05NY1	FVG06BV1 RU06NY1	FVG08BV1 RU08NY1	FVG10BV1 RU10NY1
Power supply		380-415 V, 50 Hz, 3 Phase, 4 Wires					
Cooling capacity ^{1,3}		kW	14.7	17.6	23.5	29.3	
		Btu/h	50,000	60,000	80,000	100,000	
		kcal/h	12,600	15,100	20,200	25,200	
Power consumption ¹		kW	5.5	6.4	8.6	11.2	
Indoor unit	Colour		Ivory white				
	Air flow rate (H)	m ³ /min	42	42	63	80	
		cfm	1,480	1,480	2,230	2,830	
	Fan	Drive	Direct Drive 3 Speed				
	Sound level (H/L) ²	dB(A)	59/50		60/51	61/52	
	Dimensions (HxWxD)	mm	1,870x750x510		1,870x950x510	1,870x1,170x510	
	Machine weight	kg	90	90	107	143	
Operation range		°CWB	14 to 25				
Outdoor unit	Colour		Ivory white				
	Compressor	Type	Hermetically sealed scroll type				
		Motor output	kW	4.5	4.5	6.7	9.0
	Refrigerant oil	Model	DAPHNE SE56P		MINERAL		
		Charge	L	1.4	2.5	3.3	3.3
	Refrigerant charge (R-22)	kg	2.7(Charged for 7.5 m)	3.3(Charged for 7.5 m)	5.2(Charged for 7.5 m)	6.0(Charged for 7.5 m)	
	Sound level ² (380V/415V)	dB(A)	59/60	59/60	60/61	61/62	
	Dimensions (HxWxD)	mm	1,345x900x320		1,680x930x765		
Machine weight	kg	92	105	203	206		
Operation range		°CDB	21 to 46				
Refrigerant Piping	Indoor unit	Liquid	mm	φ9.5 (Brazeing)		φ12.7 (Brazeing)	
		Gas	mm	φ19.1 (Brazeing)		φ22.2 (Brazeing) φ28.6 (Brazeing)	
		Drain	mm	PS 1B Internal thread			
	Outdoor unit	Liquid	mm	φ9.5 (Flare)		φ12.7 (Flare)	
		Gas	mm	φ19.1 (Flare)		φ22.2 (Brazeing) φ28.6 (Brazeing)	
		Drain	mm	φ26.0 (Hole)			
Max. interunit piping length		m	50 (equivalent length 70 m)				
Max. installation level difference		m	30				

■ FLOOR STANDING TYPE Cooling only DUCT CONNECTION TYPE

Model Name		Indoor unit		10HP	13HP	15HP	18HP	20HP
		Outdoor unit		FVPG10BY1 RU10NY1	FVPG13BY1 RU13NY1	FVPG15BY1 RU15NY1	FVPG18BY1 RU18NY1	FVPG20BY1 RU20NY1
Power supply		380-415 V, 50 Hz, 3 Phase, 4 Wires						
Cooling capacity ^{1,3}		kW	29.3	35.2	46.9	52.8	58.6	
		Btu/h	100,000	120,000	160,000	180,000	200,000	
		kcal/h	25,200	30,200	40,300	45,400	50,400	
Power consumption ¹		kW	11.4	14.9	17.8	21.2	24.8	
Indoor unit	Colour		Ivory white					
	Air flow rate (H)	m ³ /min	80	120	120	162	162	
		cfm	2,830	4,240	4,240	5,720	5,720	
	Fan	Drive	Belt Drive					
	Ext. Static Pressure	mmH ₂ O	15	15	15	15	15	
	Sound level ²	dB(A)	61	62	62	63	63	
	Dimensions (HxWxD)	mm	1,740x1,170x510	1,870x1,170x720		1,870x1,470x720	1,870x1,470x720	
Machine weight	kg	150	180	180	240	240		
Operation range		°CWB	14 to 25					
Outdoor unit	Colour		Ivory white					
	Compressor	Type	Hermetically sealed scroll type					
		Motor output	kW	9.0	5.0+5.0	6.7+6.7	7.5+7.5	9.0+9.0
	Refrigerant oil	Model	MINERAL					
		Charge	L	3.3	3.3	6.5	6.5	6.5
	Refrigerant charge (R-22)	kg	6.0(Charged for 7.5 m)	5.0(Charged for 7.5 m)	7.5(Charged for 7.5 m)	8.0(Charged for 7.5 m)	9.0(Charged for 7.5 m)	
	Sound level ² (380V/415V)	dB(A)	61/62	61/62	62/63	63/64	63/64	
	Dimensions (HxWxD)	mm	1,680x930x765	1,680x1,240x765				
Machine weight	kg	206	243	319	322	329		
Operation range		°CDB	21 to 46					
Refrigerant Piping	Indoor unit	Liquid	mm	φ12.7 (Brazeing)		φ15.9 (Brazeing)		
		Gas	mm	φ28.6 (Brazeing)		φ34.9 (Brazeing)		
		Drain	mm	PS 1B Internal thread				
	Outdoor unit	Liquid	mm	φ12.7 (Flare)		φ15.9 (Flare)		
		Gas	mm	φ28.6 (Brazeing)		φ34.9 (Brazeing)		
		Drain	mm	——				
Max. interunit piping length		m	50 (equivalent length 70 m)					
Max. installation level difference		m	30					

Note :
¹Rated cooling capacities are based on the following conditions:
 Return air temp., 27°CDB, 19.5°CWB; outdoor temp. 35°CDB. Equiv. refrigeration piping, 5 m (horizontal).
²Anechoic chamber conversion value, measured according to JIS parameters and criteria.
 During operation these values are somewhat higher owing to ambient conditions.
³Capacity includes indoor fan motor heat.

DUCT TYPE Cooling only

Model Name	Indoor unit		5HP	6HP	8HP	10HP
	Outdoor unit		FD05KAY1	FD06KAY1	FD08KAY1	FD10KAY1
			RU05NY1	RU06NY1	RU08NY1	RU10NY1
Power supply	380-415 V, 50 Hz, 3 phase, 4 Wires					
Cooling capacity ^{1,3}		kW	14.7	17.6	23.5	29.3
		Btu/h	50,000	60,000	80,000	100,000
		kcal/h	12,600	15,100	20,200	25,200
Power consumption ¹		kW	5.6	6.5	9.0	11.4
Indoor unit	Colour		Galvanize steel			
	Airflow rate (H)	m ³ /min	46	54	68	78
		cfm	1,620	1,910	2,400	2,750
	Fan	External static pressure	9			
		Driving system	Belt drive			
	Sound level (H) ²	dB(A)	49	51	53	53
	Dimensions (HxWxD)	mm	450x900x850	450x1,130x850	500x1,130x850	500x1,330x850
	Machine weight	kg	72	79	93	104
Operation range	°CWB	14 to 25				
Outdoor unit	Colour		Ivory white			
	Compressor	Type	Hermetically sealed scroll type			
		Motor output	kW	4.5	4.5	6.7
	Refrigerant oil	Model	DAPHNE SE56P			
		Charge	L	1.4	2.5	3.3
	Refrigerant charge (R-22)	kg	2.7 (Charged for 7.5 m)	3.3 (Charged for 7.5 m)	5.2 (Charged for 7.5 m)	6.0 (Charged for 7.5 m)
	Sound level ² (380V/415V)	dB(A)	59/60	59/60	60/61	61/62
	Dimensions (HxWxD)	mm	1,345x900x320		1,680x930x765	
Machine weight	kg	92	105	203	206	
Operation range	°CDB	21 to 46				
Piping connections	Indoor unit	Liquid	mm		ø9.5(Brazing)	
		Gas	mm		ø19.1(Brazing)	
		Drain	mm		ø22.2(Brazing)	
	Outdoor unit	Liquid	mm		ø12.7(Brazing)	
		Gas	mm		ø22.2(Brazing)	
		Drain	mm		ø28.6(Brazing)	
Max. interunit piping length		m	50 (equivalent length 70 m)			
Max. installation level difference		m	30			

Model Name	Indoor unit		13HP	15HP	18HP	20HP
	Outdoor unit		FD13KAY1	FD15KAY1	FD18KAY1	FD20KAY1
			RU13NY1	RU15NY1	RU18NY1	RU20NY1
Power supply	380-415 V, 50 Hz, 3 phase, 4 Wires					
Cooling capacity ^{1,3}		kW	35.2	46.9	52.8	58.6
		Btu/h	120,000	160,000	180,000	200,000
		kcal/h	30,200	40,300	45,400	50,400
Power consumption ¹		kW	15.0	17.9	21.5	25.1
Indoor unit	Colour		Galvanize steel			
	Airflow rate (H)	m ³ /min	136		166	
		cfm	4,800		5,860	
	Fan	External static pressure	15			
		Driving system	Belt drive			
	Sound level (H) ²	dB(A)	58		60	
	Dimensions (HxWxD)	mm	625x1,620x850		625x1,980x850	
	Machine weight	kg	161		187	
Operation range	°CWB	14 to 25				
Outdoor unit	Colour		Ivory white			
	Compressor	Type	Hermetically sealed scroll type			
		Motor output	kW	5.0+5.0	6.7+6.7	7.5+7.5
	Refrigerant oil	Model	MINERAL			
		Charge	L	3.3	6.5	6.5
	Refrigerant charge (R-22)	kg	5.0 (Charged for 7.5 m)	7.5 (Charged for 7.5 m)	8.0 (Charged for 7.5 m)	9.0 (Charged for 7.5 m)
	Sound level ² (380V/415V)	dB(A)	61/62	62/63	63/64	63/64
	Dimensions (HxWxD)	mm	1,680x1,240x765			
Machine weight	kg	243	319	322	329	
Operation range	°CDB	21 to 46				
Piping connections	Indoor unit	Liquid	mm		ø12.7(Brazing)	
		Gas	mm		ø15.9(Brazing)	
		Drain	mm		ø34.9(Brazing)	
	Outdoor unit	Liquid	mm		ø12.7(Flare)	
		Gas	mm		ø28.6(Brazing)	
		Drain	mm		ø34.9(Brazing)	
Max. interunit piping length		m	50 (equivalent length 70 m)			
Max. installation level difference		m	30			

Note :

¹Rated cooling capacities are based on the following conditions:
Suction temp., 27°CDB, 19.5°CWB; outdoor temp. 35°CDB. Equip. refrigeration piping, 5 m (horizontal).

²Anechoic chamber conversion value, measured according to JIS parameters and criteria.

During operation these values are somewhat higher owing to ambient conditions.

³Capacity includes indoor fan motor heat.

SPECIFICATIONS

DUCT TYPE Heat pump

Model Name		Indoor unit		6HP	8HP	10HP	15HP	20HP
		Outdoor unit		FDY06KAY1 RY140LUY1	FDY08KAY1 RY200KUY1	FDY10KAY1 RY250KUY1	FDY15KAY1 RY200KUY1×2	FDY20KAY1 RY250KUY1×2
Power supply		380-415 V, 50 Hz, 3 phase, 4 wires						
Cooling capacity ¹		kW	14.5	22.5	27.6	44.0	53.9	
		Btu/h	49,500	76,800	94,200	150,000	184,000	
Heating capacity ²		kcal/h	12,500	19,300	23,700	37,800	46,400	
		kW	15.3	23.1	29.4	44.6	56.6	
		Btu/h	52,200	78,800	100,300	152,000	193,000	
Power consumption		Cooling ¹	kW	5.14	7.2	9.3	14.4	18.5
		Heating ²	kW	4.54	6.1	8.8	12.2	17.6
Indoor unit	Colour		—					
	Airflow rate (H)		m ³ /min	52	68	83	136	166
			cfm	1,835	2,400	2,930	4,800	5,860
	Fan	External static pressure	Pa	108	118			147
		Driving system		Belt drive				
	Sound level (H) ³		dB(A)	51		53	58	60
	Dimensions(H×W×D) ⁵		mm	450×1,130×850	500×1,130×850	500×1,330×850	625×1,620×850	625×1,980×850
	Machine weight		kg	80	94	105	161	187
	Operation range	Cooling	°CWB	12 to 25		14 to 25		
		Heating	°CDB	15 to 27				
Outdoor unit	Colour		Ivory white					
	Compressor	Type	Hermetically sealed scroll type					
		Motor output	kW	4.5	5.5	9.0	5.5×2	9.0×2
	Refrigerant oil	Model	SUNISO 4GSDID-K					
		Charge	L	1.6	3.0	3.0	3.0×2	3.0×2
	Refrigerant charge (R-22)		kg	4.1 (Charged for 30 m)	4.0 (Charged for 5 m)	5.5 (Charged for 5 m)	4.0 (Charged for 5 m)×2	5.5 (Charged for 5 m)×2
	Sound level (Cooling/Heating) ³		dB(A)	54/56	60/62	61/63	60/62 ⁴	61/63 ⁴
	Dimensions (H×W×D)		mm	1,345×900×320	1,220×1,280×690	1,440×1,280×690	(1,220×1,280×690)×2	(1,440×1,280×690)×2
	Machine weight		kg	112	180	206	180×2	206×2
	Operation range	Cooling	°CDB	-5 to 46		0 to 50		
Heating		°CWB	-10 to 15					
Piping connections	Liquid (Flare)		mm	φ 9.5	φ 12.7	φ 15.9	φ 12.7×2	φ 15.9×2
	Gas		mm	φ 19.1 (Flare)	φ 25.4 (Flange)	φ 28.6 (Flange)	φ 25.4×2 (Flange)	φ 28.6×2 (Flange)
	Indoor unit	Drain	mm	3/4B				1B
	Outdoor unit		mm	φ 26.0 (Hole)				
Max. interunit piping length		m	50 (equivalent length 70 m)					
Max. installation level difference		m	30					

Note :

¹Rated cooling capacities are based on the following conditions:

Suction temp., 27°CDB, 19.5°CWB; outdoor temp. 35°CDB. Equiv. refrigeration piping, 5 m (horizontal). (RY140LU is 7.5 m.)

²Rated heating capacities are based on the following conditions:

Suction temp., 21°CDB; outdoor temp., 7°CDB, 6°CWB. Equiv. refrigeration piping, 5 m (horizontal). (RY140LU is 7.5 m.)

³Anechoic chamber conversion value, measured according to JIS parameters and criteria. During operation these values are somewhat higher owing to ambient conditions.

⁴Specification for outdoor unit is for a single unit only.

⁵Without control box.

Fan Performance

■ FLOOR STANDING TYPE DUCT CONNECTION TYPE

FVPG10BY1

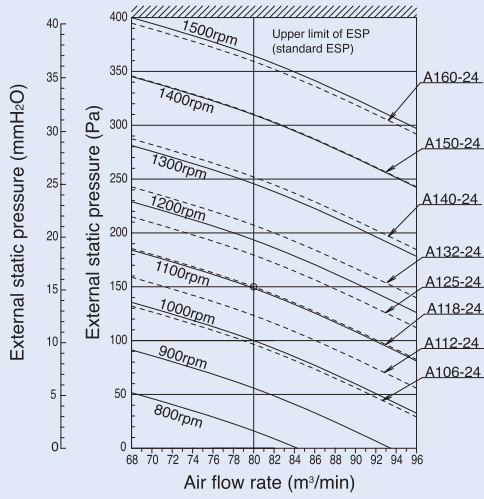

FVPG13BY1
FVPG15BY1

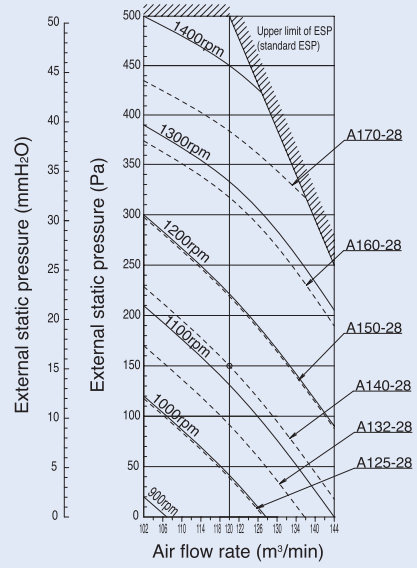

FVPG18BY1
FVPG20BY1

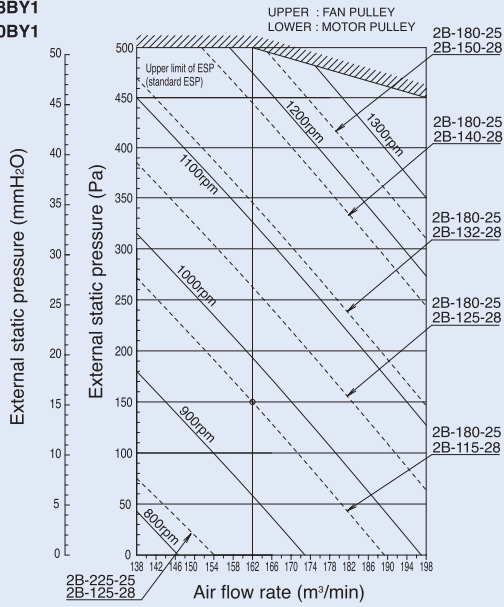

Fan Performance

DUCT TYPE

FD05KAY1

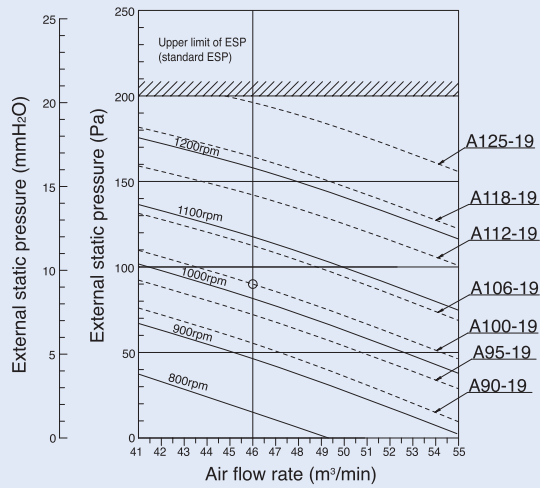

FD06KAY1

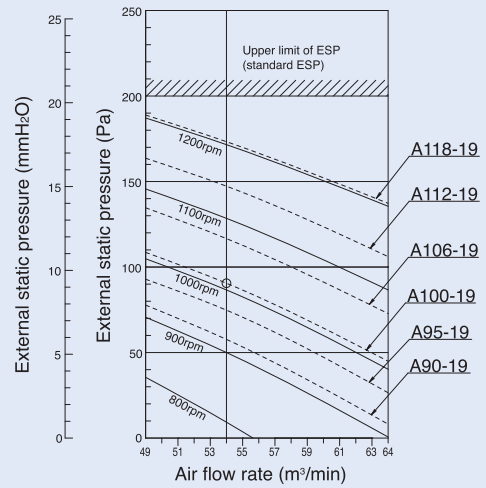

FD08KAY1

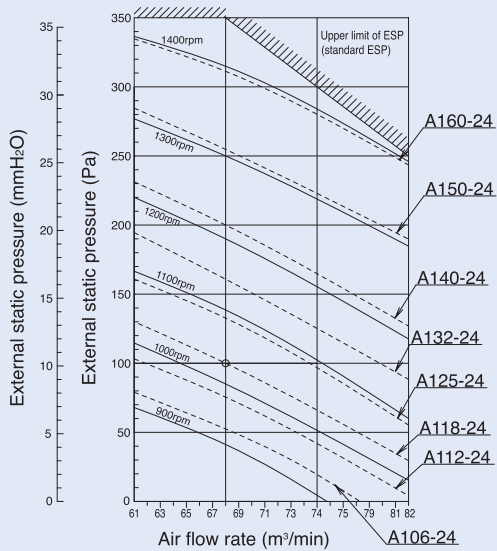

FD10KAY1

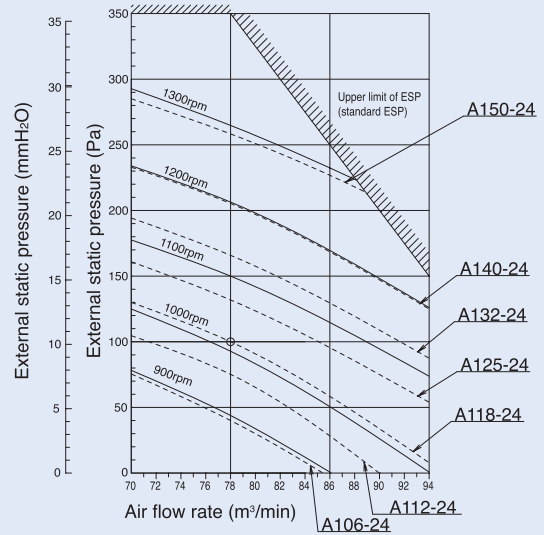

**FD13KAY1
FD15KAY1**

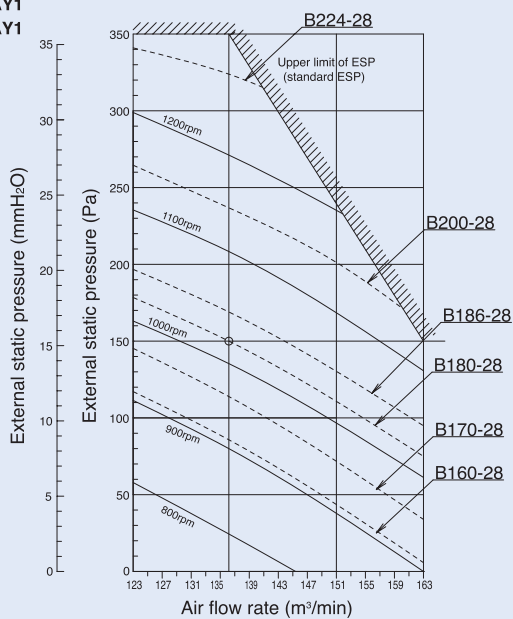

**FD18KAY1
FD20KAY1**

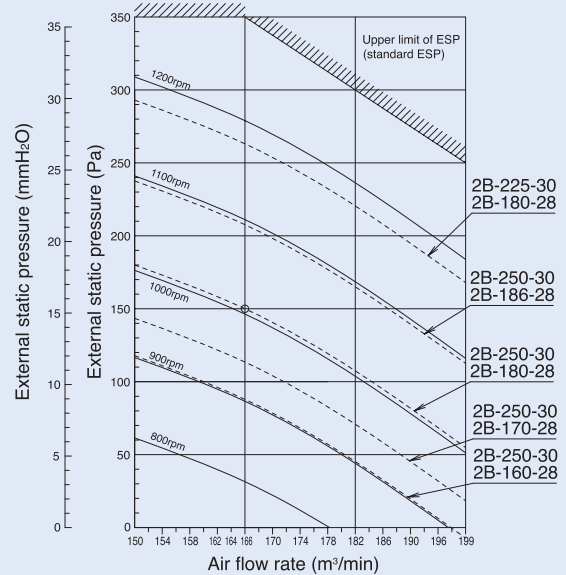

DUCT TYPE

FDY06KAY1

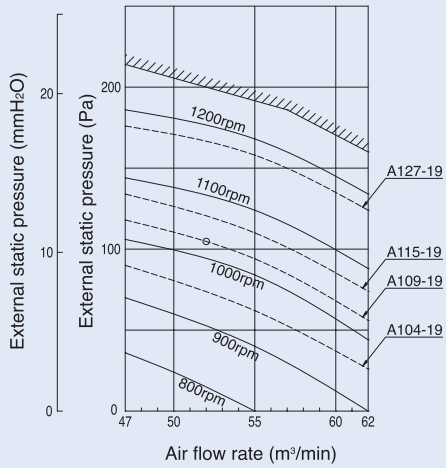

FDY08KAY1

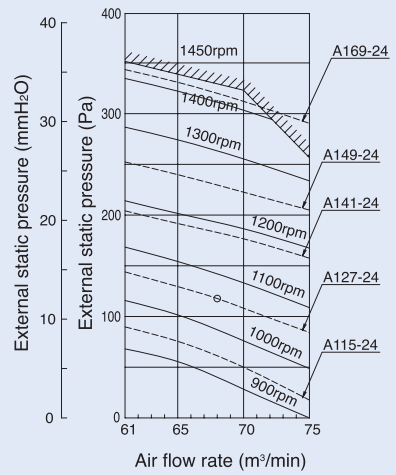

FDY10KAY1

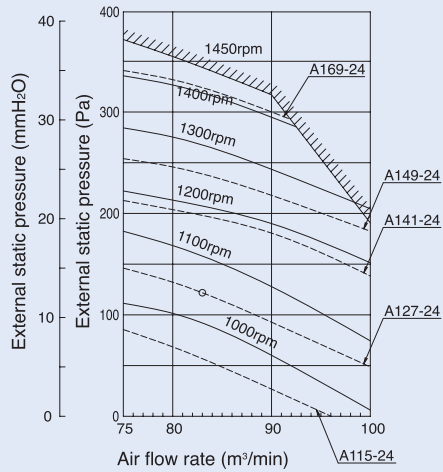

FDY15KAY1

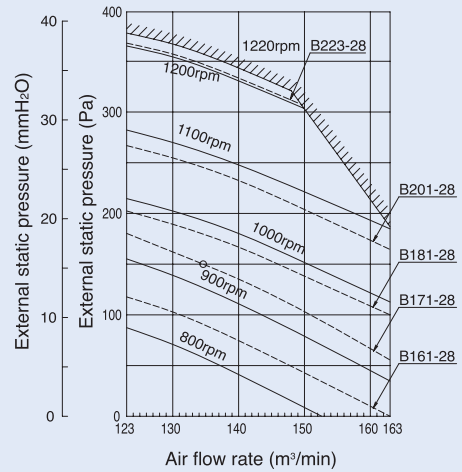

FDY20KAY1

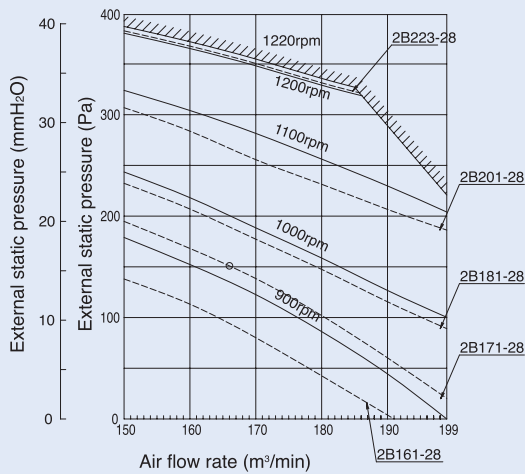

Wiring and Piping

■ FLOOR STANDING TYPE DIRECT AIR BLOW TYPE

FVG05B/06B
RU05N/06N

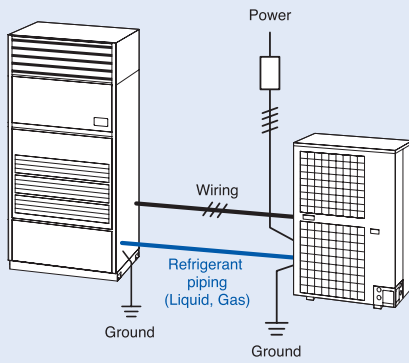

FVG08B/10B
RU08N/10N

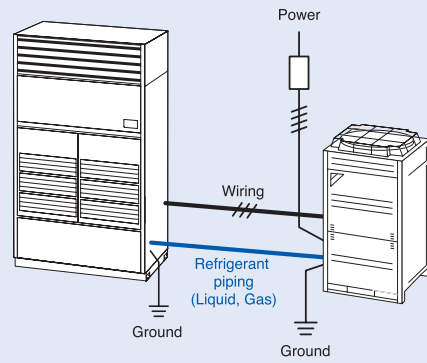

■ FLOOR STANDING TYPE DUCT CONNECTION TYPE

FVPG10B
RU10N

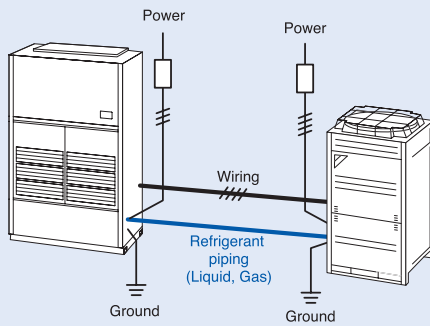

FVPG13B/15B/18B/20B
RU13N/15N/18N/20N

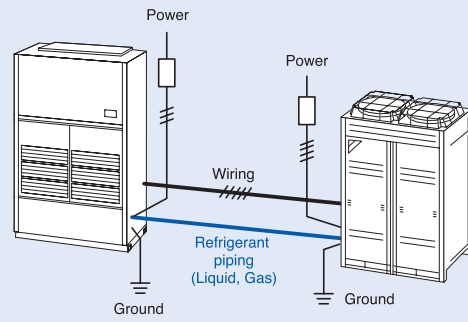

DUCT TYPE

FD05KA/06KA
RU05N/06N

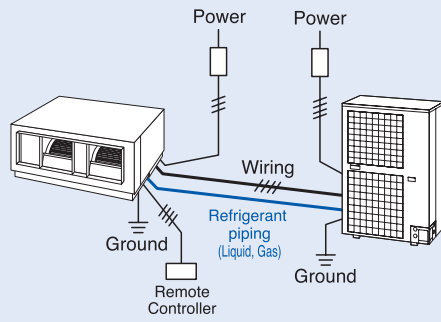

FD08KA/10KA
RU08N/10N

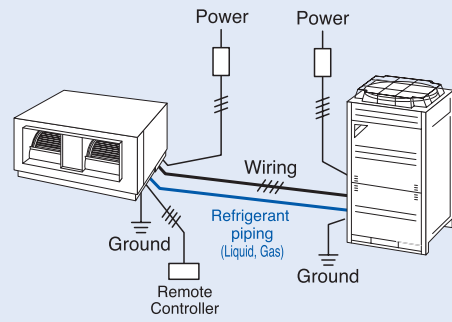

FD13KA/15KA/18KA/20KA
RU13N/15N/18N/20N

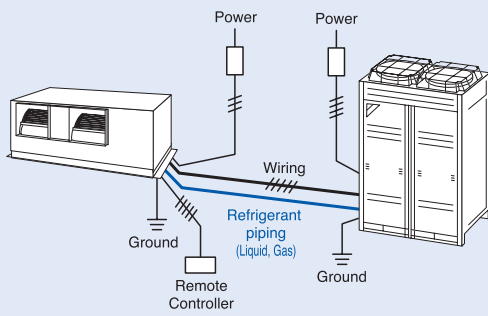

FDY06KA
RY140LU

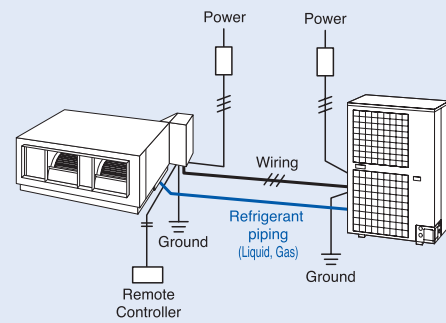

FDY08KA/10KA
RY200KU/250KU

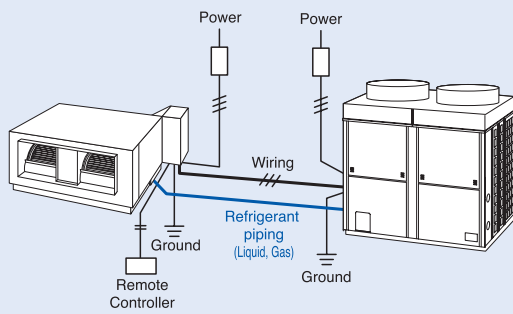

FDY15KA/20KA
RY200KU×2/250KU×2

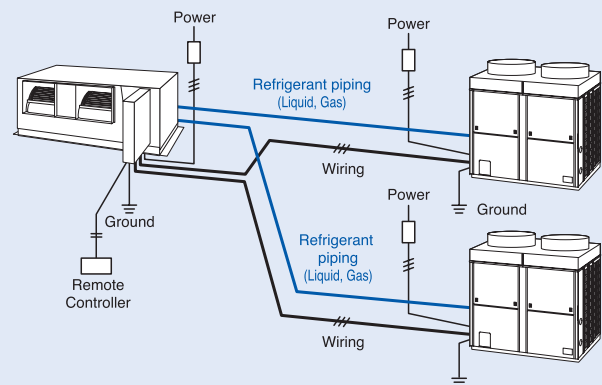

■ FLOOR STANDING TYPE DIRECT AIR BLOW TYPE

FVG05BV1
FVG06BV1
FVG08BV1

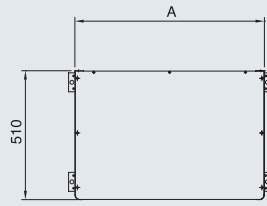

	A	B	C	D
FVG05BV1	750	720	∅ 9.5	∅ 19.1
FVG06BV1	750	720	∅ 9.5	∅ 19.1
FVG08BV1	950	920	∅ 12.7	∅ 22.2

- ① Liquid pipe conn. (C) C1220T brazing
- ② Gas pipe conn. (D) C1220T brazing
- ③ Upper drain outlet (PS 1B Internal thread)
- ④ Power supply & control wire intake
- ⑤ Digital remote controller

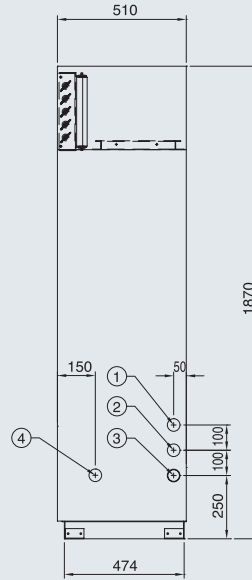
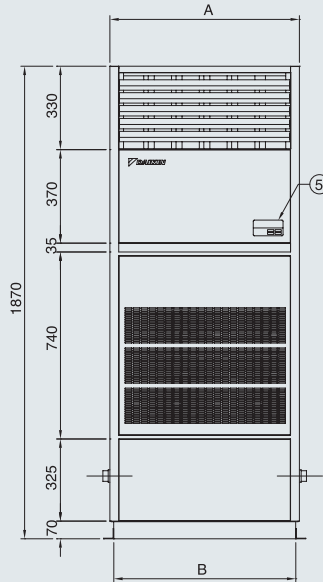

SDR3150151
SDR3150152
SDR3150153

FVG10BV1

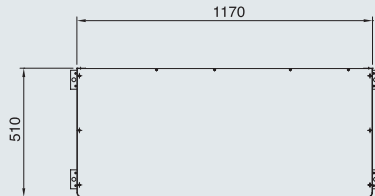

- ① Liquid pipe conn. (∅ 12.7) C1220T brazing
- ② Gas pipe conn. (∅ 28.6) C1220T brazing
- ③ Upper drain outlet (PS 1B Internal thread)
- ④ Power supply & control wire intake
- ⑤ Digital remote controller

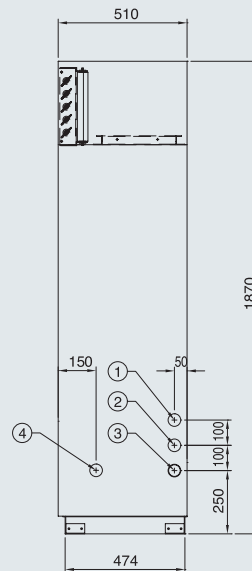
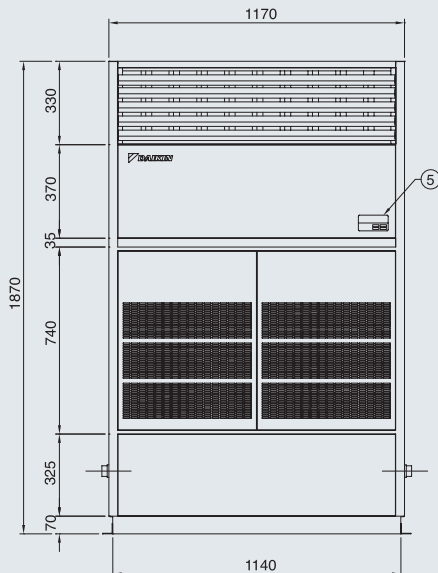

SDR3150154

FLOOR STANDING TYPE
DUCT CONNECTION TYPE

FVPG10BY1

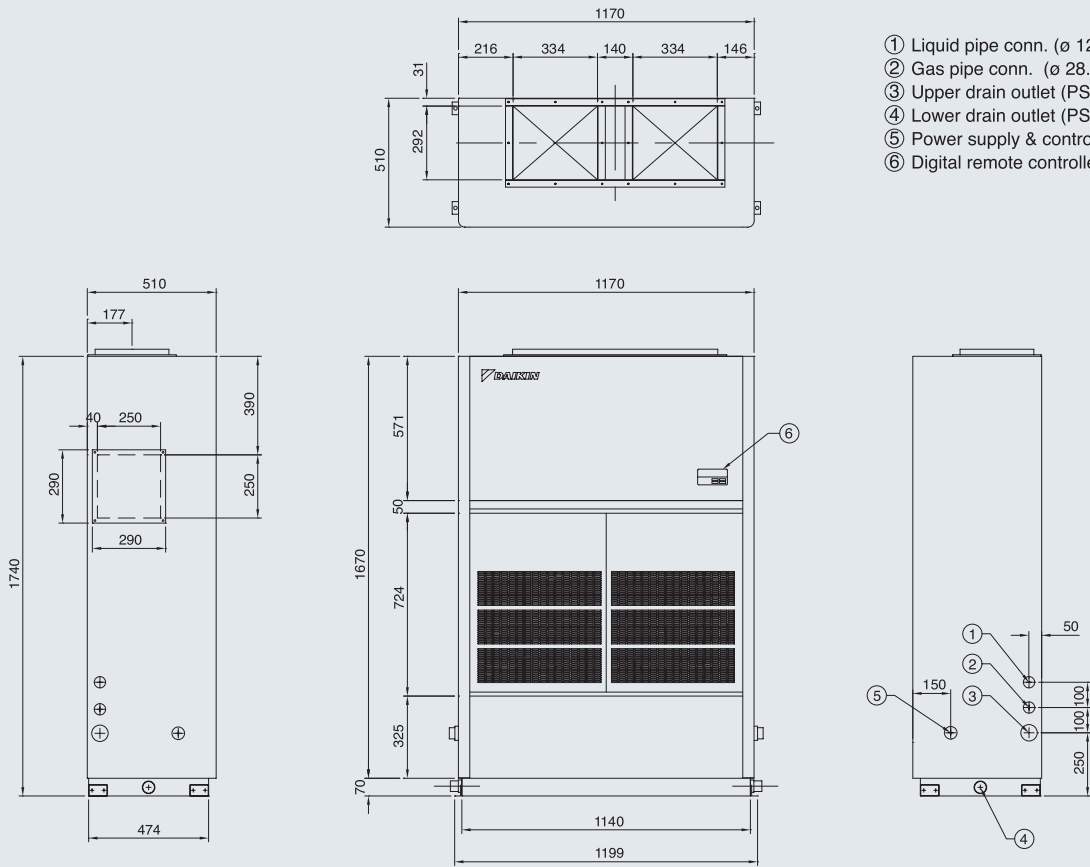

- ① Liquid pipe conn. (ø 12.7) C1220T brazing
- ② Gas pipe conn. (ø 28.6) C1220T brazing
- ③ Upper drain outlet (PS 1B Internal thread)
- ④ Lower drain outlet (PS 1B Internal thread)
- ⑤ Power supply & control wire intake
- ⑥ Digital remote controller

SDR3150155

FVPG13BY1
FVPG15BY1
FVPG18BY1
FVPG20BY1

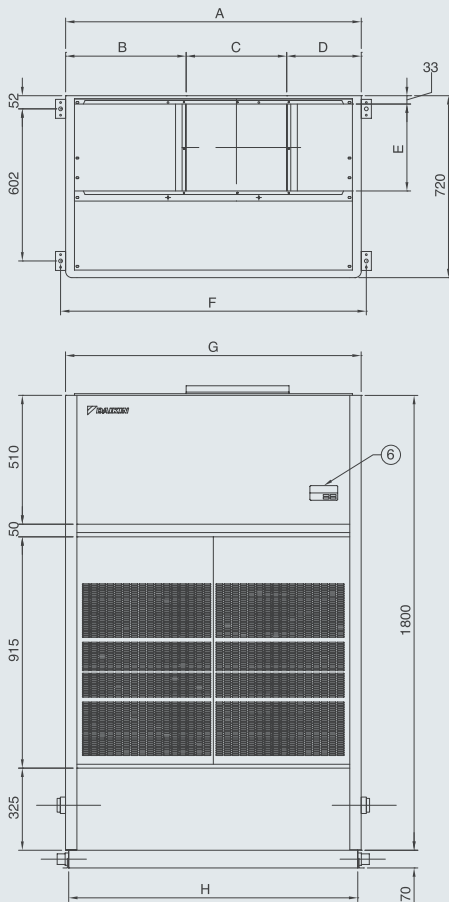

	A	B	C	D	E	F	G	H	J	K	L
FVPG13BY1	1170	477	398	295	344	1210	1170	1144	205	ø12.7	ø28.6
FVPG15BY1	1170	477	398	295	344	1210	1170	1144	205	ø15.9	ø34.9
FVPG18BY1	1470	558	474	438	407	1510	1470	1444	237	ø15.9	ø34.9
FVPG20BY1	1470	558	474	438	407	1510	1470	1444	237	ø15.9	ø34.9

- ① Liquid pipe conn. (K) C1220T brazing
- ② Gas pipe conn. (L) C1220T brazing
- ③ Upper drain outlet (PS 1B Internal thread)
- ④ Lower drain outlet (PS 1B Internal thread)
- ⑤ Power supply & control wire intake
- ⑥ Digital remote controller

SDR3150156
SDR3150157
SDR3150158

DUCT TYPE

FD05KAY1

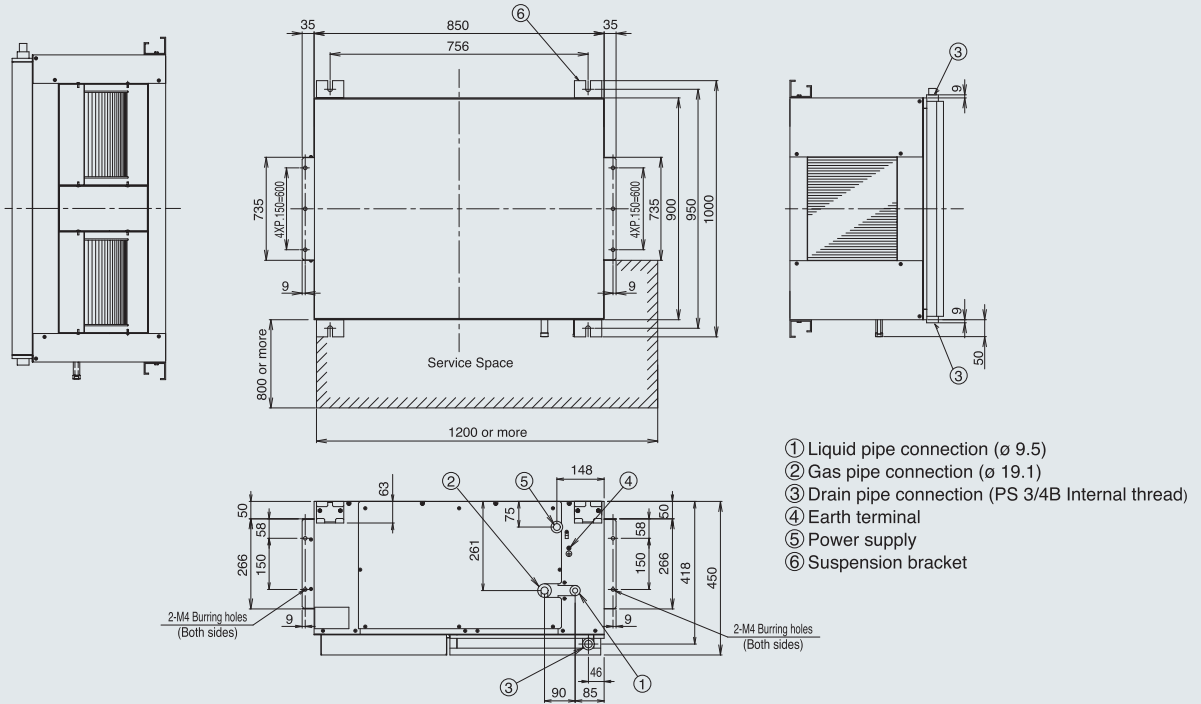

3D062899A

DUCT TYPE

FD06KAY1

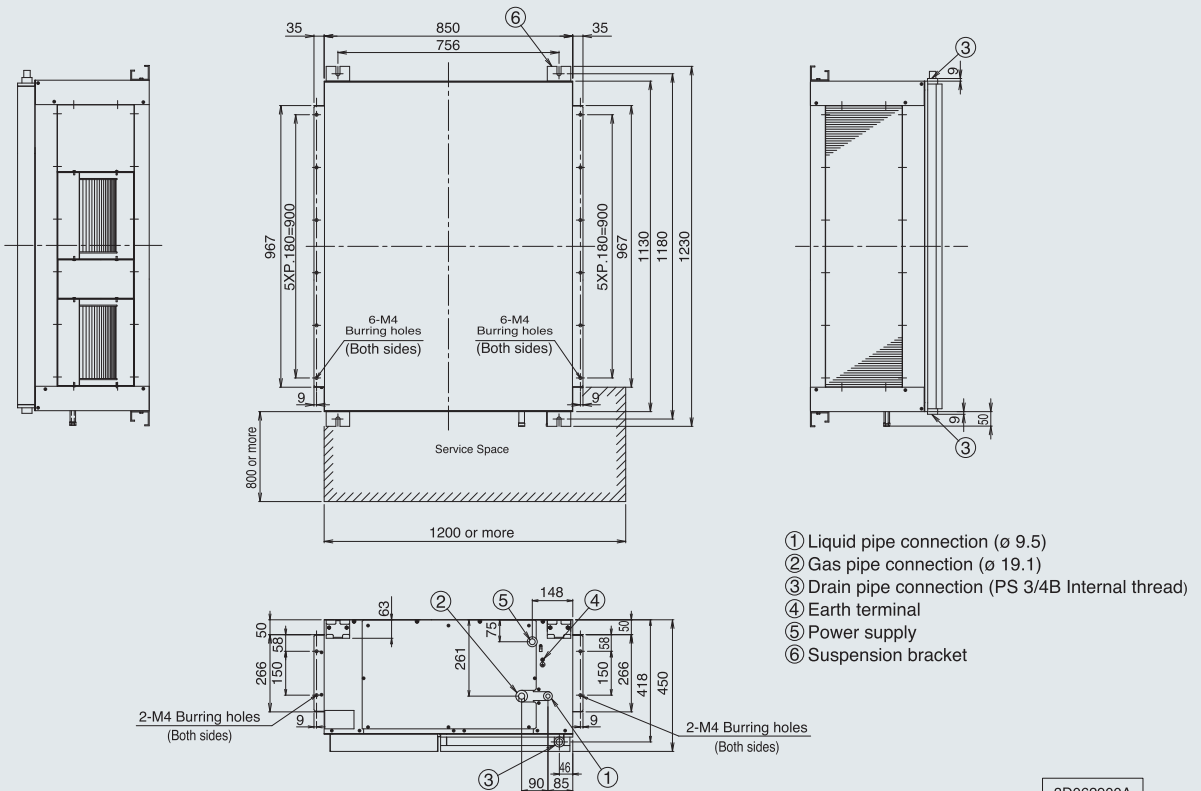

3D062900A

DIMENSIONS

(Unit: mm)

DUCT TYPE

FDY06KAY1 / 08KAY1 / 10KAY1

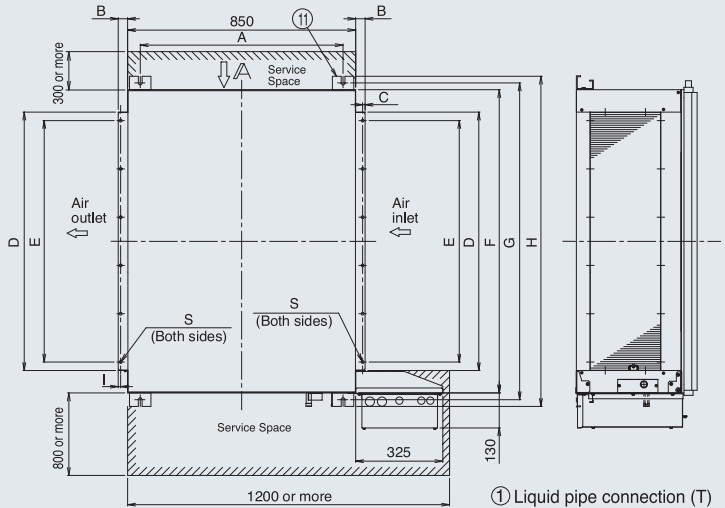
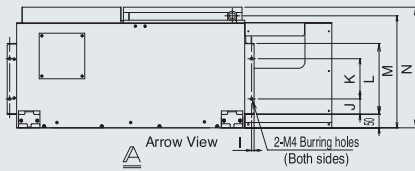
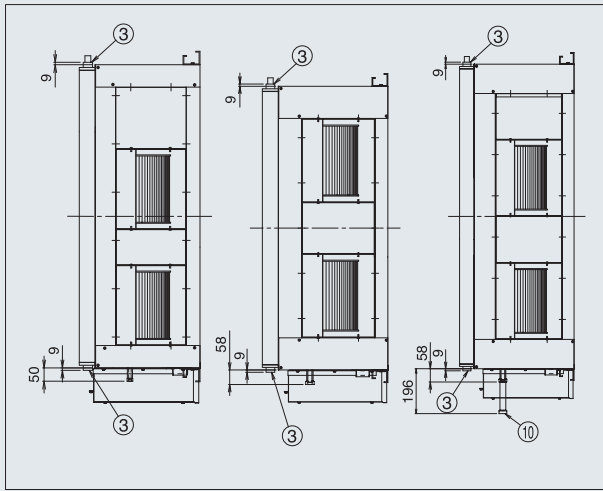

- ① Liquid pipe connection (T)
- ② Gas pipe connection (U)
- ③ Drain pipe connection (3/4B)
- ④ Earth terminal
- ⑤ Hole for power supply
- ⑥ Hole for motor wiring
- ⑦ Hole for wiring from outdoor unit
- ⑧ Hole for remote controller wiring
- ⑨ Control box
- ⑩ Auxiliary pipe
- ⑪ Suspension bracket

	A	B	C	D	E	F	G	H	I	J	K	L	M	N	O	P	Q	S	T	U
FDY06KAY1	756	35	9	967	5XP.180=900	1130	1180	1230	9	58	150	266	418	450	261	90	85	6-M4 Burring holes	ø9.5	ø19.1
FDY08KAY1	732	39	10	876	4XP.180=720	1130	1180	1230	10	67	160	294	468	500	311	79	47	5-M4 Burring holes	ø12.7	ø25.4
FDY10KAY1	732	39	10	1076	5XP.180=900	1330	1380	1430	10	67	160	294	468	500	311	79	47	6-M4 Burring holes	ø15.9	ø28.6

3D029836A
3D029841A
3D029842A

Note: ¹Location of unit's Name Plate: Lid of control box.

DUCT TYPE

FDY15KAY1 / 20KAY1

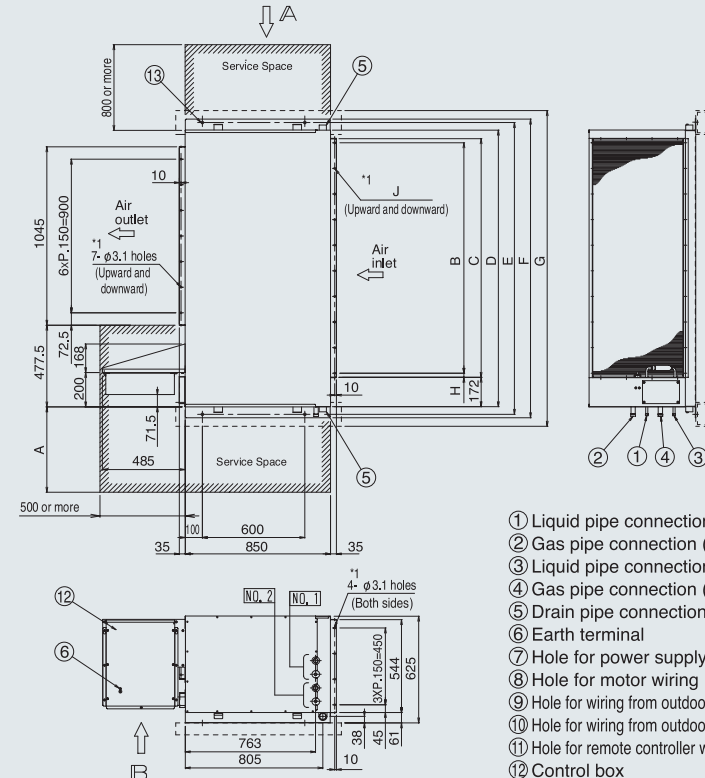
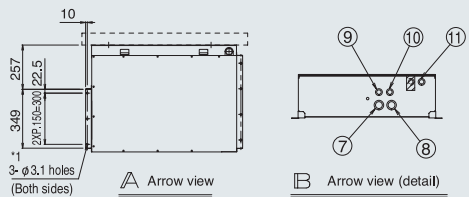
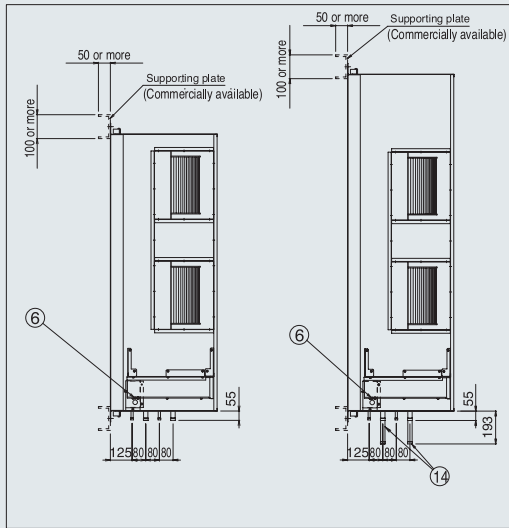

- ① Liquid pipe connection (No.1)(K)
- ② Gas pipe connection (No.1)(L)
- ③ Liquid pipe connection (No.2)(1B)
- ④ Gas pipe connection (No.2)
- ⑤ Drain pipe connection
- ⑥ Earth terminal
- ⑦ Hole for power supply
- ⑧ Hole for motor wiring
- ⑨ Hole for wiring from outdoor unit (No.1)
- ⑩ Hole for wiring from outdoor unit (No.2)
- ⑪ Hole for remote controller wiring
- ⑫ Control box
- ⑬ The holes for anchor bolts
- ⑭ Auxiliary pipe

	A	B	C	D	E	F	G	H	J	K	L
FDY15KAY1	500	9xP.150=1350	1402	1620	1710	1750	1770	24	10-ø3.1 holes	ø12.7x2	ø25.4x2
FDY20KAY1	800 or more	11xP.150=1650	1762	1980	2070	2110	2220	54	12-ø3.1 holes	ø15.9x2	ø28.6x2

3D029843A
3D029844A

Notes: ¹Prepared holes for M4 tapping screw.

OUTDOOR UNIT

RU05NY1 / 06NY1, RY140LUY1

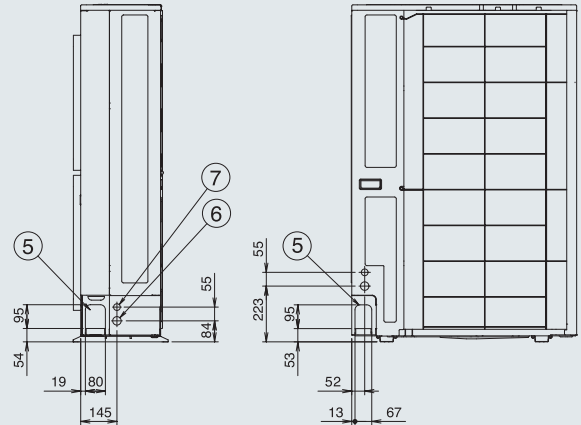
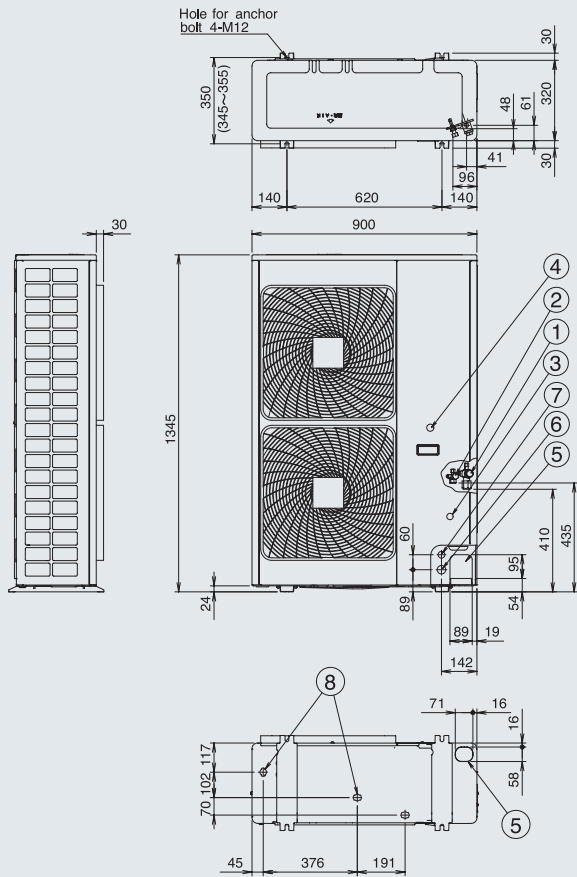

- ① Gas pipe connection
- ② Liquid pipe connection
- ③ Service port (in the unit)
- ④ Grounding terminal M5 (in switch box)
- ⑤ Refrigerant piping intake
- ⑥ Power supply wiring intake
- ⑦ Control wiring intake
- ⑧ Drain pipe connection

3D063042
3D039216

OUTDOOR UNIT

RU08NY1 / 10NY1

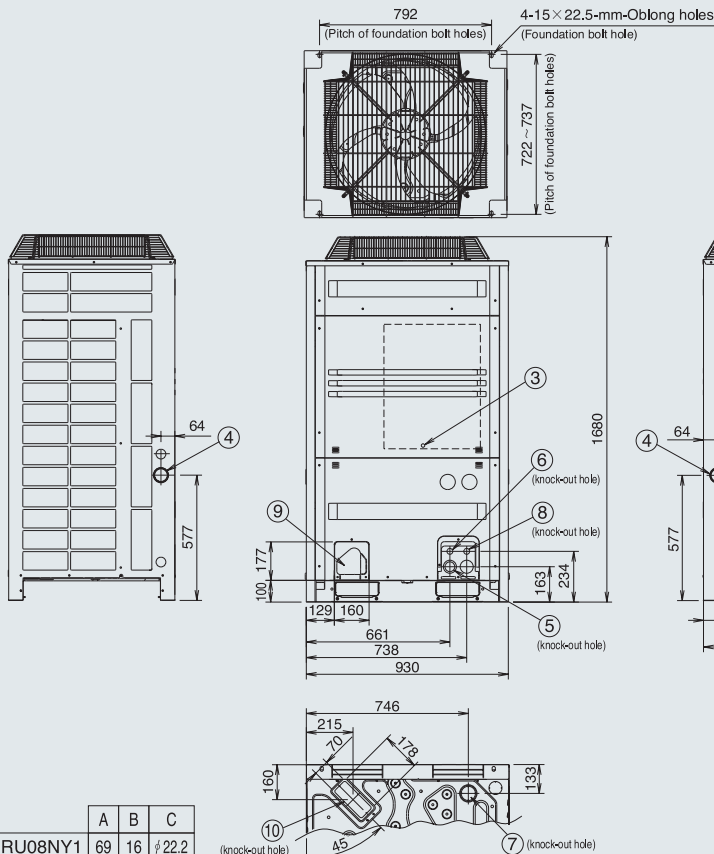

Notes) 1. Detail For Front Side And Detail For Bottom Side Indicate The Dimensions After Fixing The Attached Piping.

- 2. Gas pipe (C) Brazing connection
- Liquid pipe
- ∠ 12.7 Flare connection

- ① Liquid pipe connection port
- ② Gas pipe connection port
- ③ Grounding terminal
- ④ Power cord routing hole (side)
- ⑤ Power cord routing hole (front)
- ⑥ Power cord routing hole (front)
- ⑦ Power cord routing hole (bottom)
- ⑧ Wire routing hole (front)
- ⑨ Pipe routing hole (front)
- ⑩ Pipe routing hole (bottom)

	A	B	C
RU08NY1	69	16	∠22.2
RU10NY1	75	22	∠28.6

3D062886A
3D062887A

DIMENSIONS

(Unit: mm)

OUTDOOR UNIT

RU13NY1 / 15NY1 / 18NY1 / 20NY1

3D062890A
3D062891A

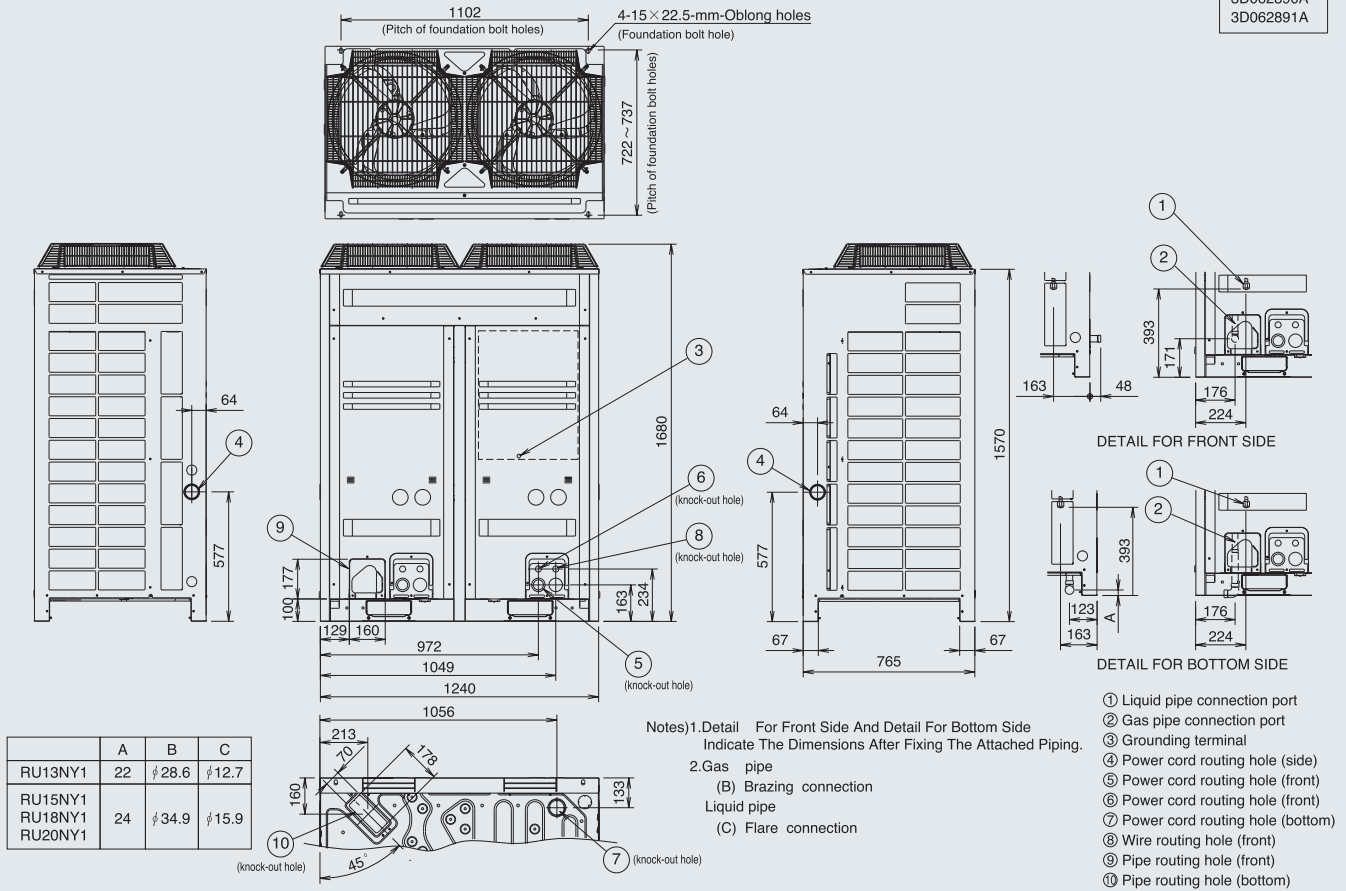

OUTDOOR UNIT

RY200KUY1 / 250KUY1

3D029264
3D029265

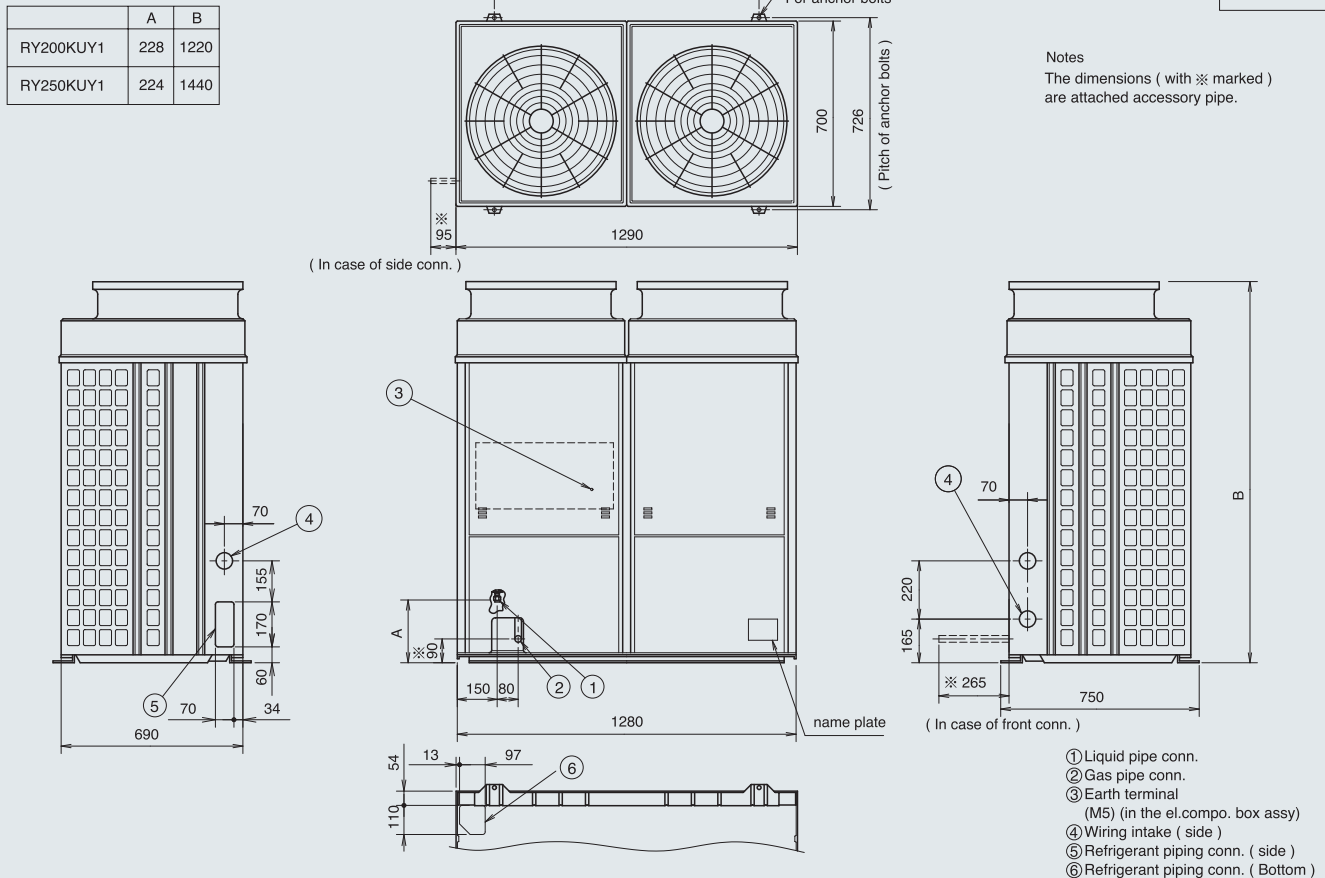

■ FLOOR STANDING TYPE DIRECT AIR BLOW TYPE

FVG05BV1
FVG06BV1
FVG08BV1
FVG10BV1

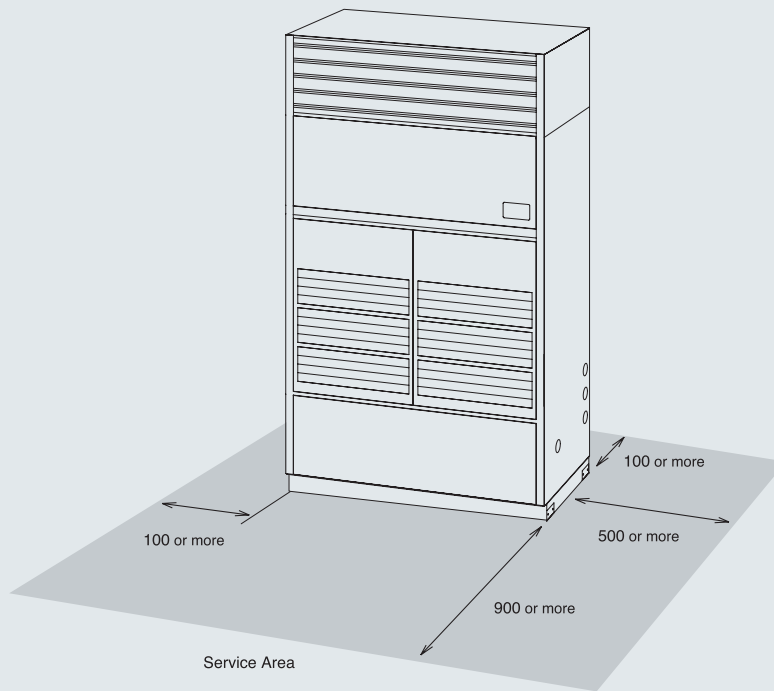

■ FLOOR STANDING TYPE DUCT CONNECTION TYPE

FVPG10BY1
FVPG13BY1
FVPG15BY1
FVPG18BY1
FVPG20BY1

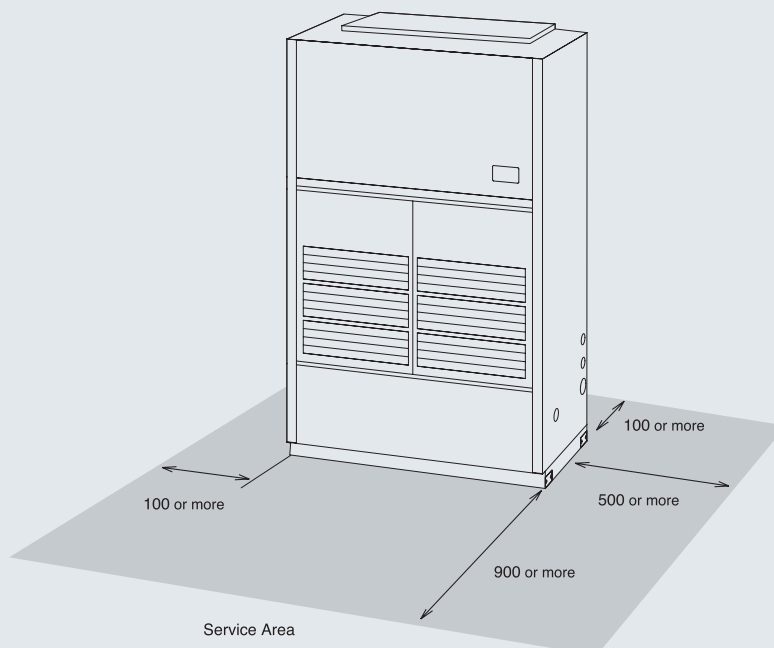

For RU05NY1/06NY1,RY140LU

When there is an obstruction on the inlet side

When the overhead space is open

1. For single unit installation

When there is an obstruction only on the inlet side

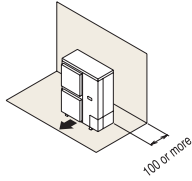

When there are obstructions on both sides

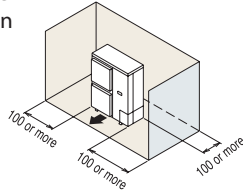

2. For series installation (more than two units)

When there are obstructions on both sides

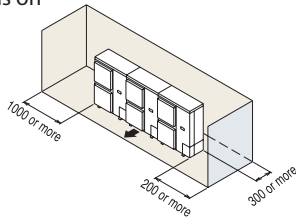

When there is an obstruction in the overhead space

1. For single unit installation

When there is an obstruction on the inlet side

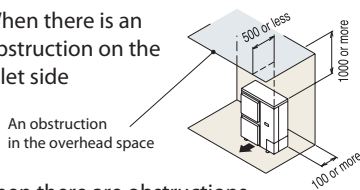

When there are obstructions on the inlet side and both lateral sides

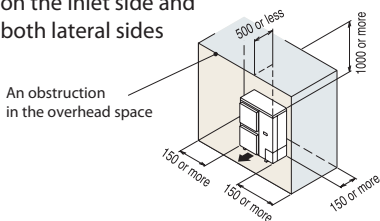

2. For series installation (more than two units)

When there are obstructions on the inlet side and both lateral sides

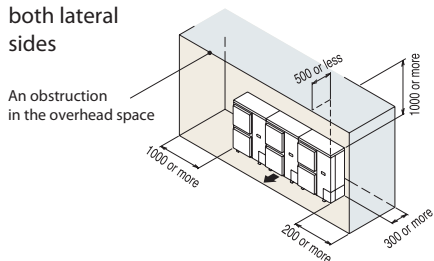

When there is an obstruction on the outlet side

When the overhead space is open

1. For single unit installation

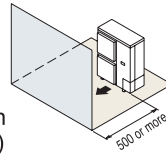

2. For series installation (more than two units)

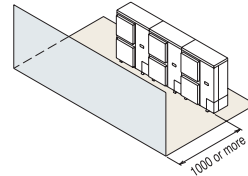

When there is an obstruction in the overhead space

1. For single unit installation

An obstruction in the overhead space

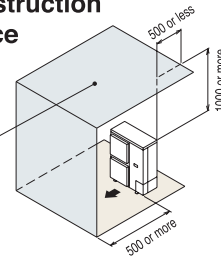

2. For series installation (more than two units)

An obstruction in the overhead space

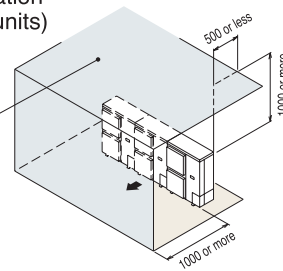

When there are obstructions on both the inlet and outlet sides

Pattern 1

For other patterns, please refer to engineering databook.

When the obstruction on the outlet side is higher than the unit itself (There is no limit to the height of the obstruction on the outlet side.)

When the overhead space is open

1. For single unit installation

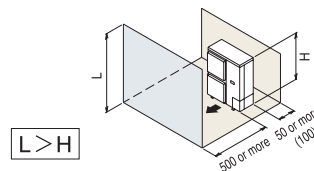

2. For series installation (more than two units)

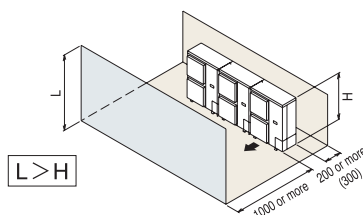

For RU08NY1/10NY1/13NY1/15NY1/18NY1/20NY1

(Please refer to engineering databook for other installation patterns.)

For single unit installation

Pattern 1

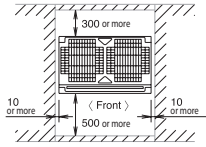

Pattern 2

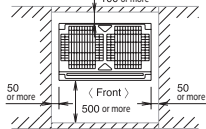

Pattern 3

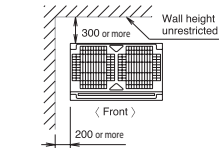

For installation in rows

Pattern 1

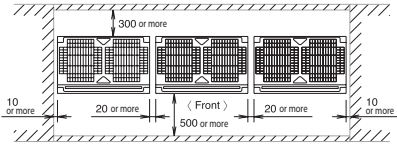

Pattern 2

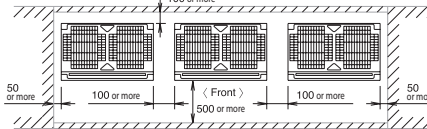

Pattern 3

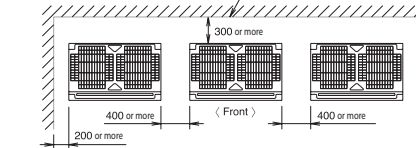

For centralized group layout

Pattern 1

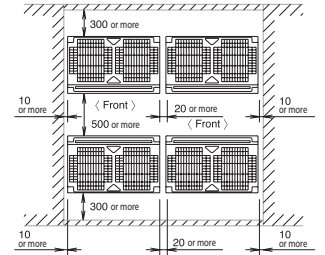
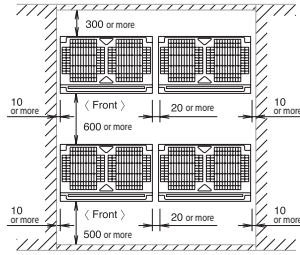

Pattern 2

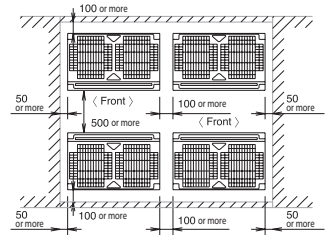
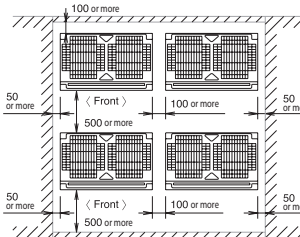

(Unit : mm)

Notes:

¹Heights of walls in case of Patterns 1 and 2:

Front : 1500 mm

Suction side : 500 mm

Side : Height unrestricted.

Installation space to be shown in this drawing is based on the cooling operation at 35 degrees outdoor air temperature. When the design outdoor air temperature exceeds 35 degrees or the load exceeds maximum ability because of much generation load of heat in all outdoor unit, take the suction side space more broadly than the space to be shown in this drawing.

²If the above wall heights are exceeded then h2/2 and h1/2 should be added to the front and suction side service spaces respectively as shown in the figure on the right.

³When installing the units most appropriate pattern should be selected from those shown above in order to obtain the best fit in the space available always bearing in mind the need to leave enough space for a person to pass between units and wall and for the air to circulate freely.

(If more units are to be installed than are catered for in the above patterns)
your layout should take account of the possibility of short circuits.

⁴The units should be installed to leave sufficient space at the front for the on site refrigerant piping work to be carried out comfortably.

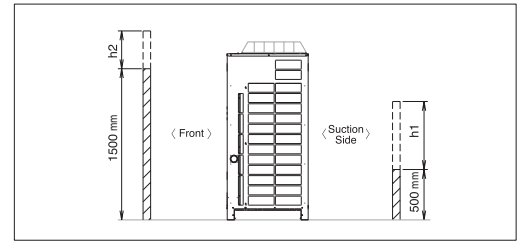

For RY200KUY1/250KUY1

Dimensions inside brackets [] indicate case where air direction adjustment guide is adjusted downward.

In case of single installation

Pattern 1

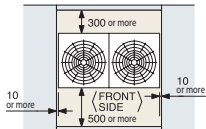

Pattern 2

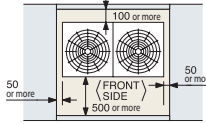

Pattern 3

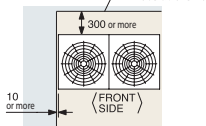

In case of parallel installation

Pattern 1

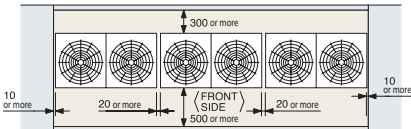

Pattern 2

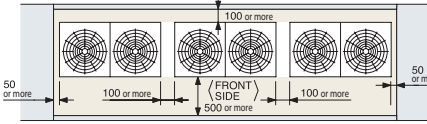

Pattern 3

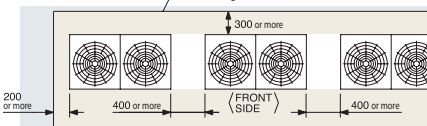

In case of set installation

Pattern 1

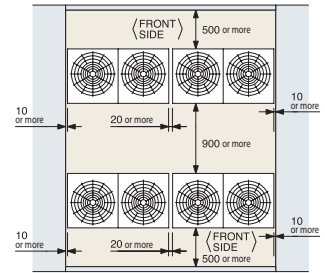
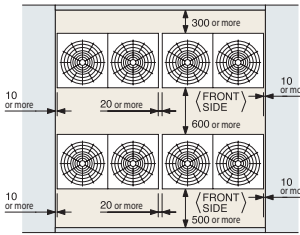

Pattern 2

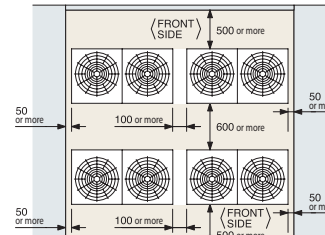
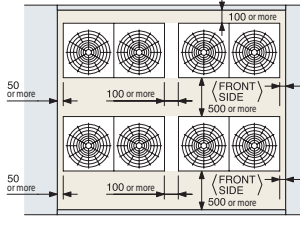

Notes:

¹Obstacles height of (Pattern 1) and (Pattern 2) shall be as follows:

Front side 1500 mm

Suction side 500 mm

Side No (imitation)

²For the service space, if the obstacle of height exceeds the above mentioned dimensions, half of the exceeded dimensions shall be added to the standard service space.

³When installing a unit, choose the most suitable one from this manual depending on actual conditions such as walking passage and ventilation.

(If the number of units is more than that shown in this manual.)
take short circuit into account.

⁴For the service space for front side, take the service space required for field piping into account.

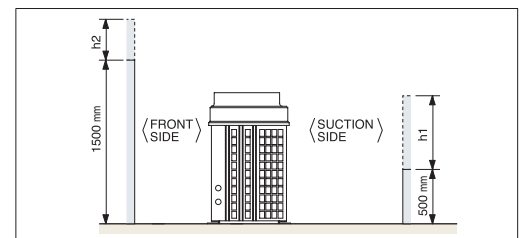

Warning



- Ask a qualified installer or contractor to install this product. Do not try to install the product yourself. Improper installation can result in water or refrigerant leakage, electrical shock, fire or explosion.
- Use only those parts and accessories supplied or specified by Daikin. Ask a qualified installer or contractor to install those parts and accessories. Use of unauthorised parts and accessories or improper installation of parts and accessories can result in water or refrigerant leakage, electrical shock, fire or explosion.
- Read the User's Manual carefully before using this product. The User's Manual provides important safety instructions and warnings. Be sure to follow these instructions and warnings.

If you have any enquiries, please contact your local importer, distributor and/or retailer.

Cautions on product corrosion

1. Air conditioners should not be installed in areas where corrosive gases, such as acid gas or alkaline gas, are produced.
2. If the outdoor unit is to be installed close to the sea shore, direct exposure to the sea breeze should be avoided. If you need to install the outdoor unit close to the sea shore, contact your local distributor.

Dealer

**DAIKIN AIRCONDITIONING
(THAILAND) LTD.**

700/444 Moo. 7 Amata Nakorn Industrial Estate
Bangna-Trad Road, km. 57, Tambol Donhualor,
Amphur Muangchonburi, Chonburi 20000 Thailand
Tel: (038)717-066-70 Fax: (038)454-184

DAIKIN INDUSTRIES, LTD.

Head Office:
Umeda Center Bldg., 2-4-12, Nakazaki-Nishi,
Kita-ku, Osaka, 530-8323 Japan

Tokyo Office:
JR Shinagawa East Bldg., 2-18-1, Konan,
Minato-ku, Tokyo, 108-0075 Japan

http://www.daikin.com/global_ac/

©All rights reserved
Printed in Japan 03/09/001 YW-HP-SS