



PCTPSG2014aprv

Perfecting the Air



DIRECT AIR BLOW



DUCT CONNECTION



DUCT TYPE



OUTDOOR UNIT

FLOOR STANDING TYPE

# INVERTER AIR COOLED PACKAGED AIR CONDITIONERS

FLOOR STANDING TYPE  
DUCT TYPE

**R-410A**

COOLING ONLY 50Hz











# Inverter Packaged Air Conditioner Line Up for Factories and Offices

## Product Line Up **R-410A**

### FLOOR STANDING TYPE

### Cooling only









50Hz

Capacity		kW	20.0	26.7	40.0	50.0
		Btu/h	68,000	91,000	136,000	171,000
FLOOR STANDING TYPE	<b>DIRECT AIR BLOW</b> Specifications Page 5					
	<b>DUCT CONNECTION</b> Specifications Page 5 <b>IE3</b>					
<b>OUTDOOR UNIT</b>						
			RZUR200PY1	RZUR250PY1	RZUR400PY1	RZUR500PY1

### DUCT TYPE

### Cooling only

50Hz

Capacity		kW	20.0	26.7	40.0	50.0
		Btu/h	68,000	91,000	136,000	171,000
<b>DUCT TYPE</b> Specifications Page 6 <b>IE3</b>						
<b>OUTDOOR UNIT</b>						
			RZUR200PY1	RZUR250PY1	RZUR400PY1	RZUR500PY1

### DIRECT AIR BLOW

#### Direct air blow from indoor unit with plenum

- Comfortable factory air conditioning using multiple indoor units installed in accordance with the space.
- Installation is next to walls, so units will not affect the factory layout even if the changes are made.

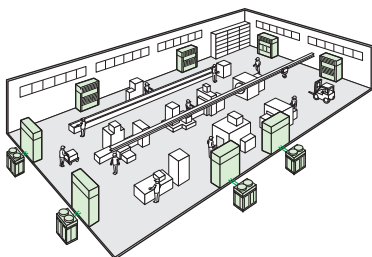

### DUCT CONNECTION

#### DUCT TYPE

#### Air blow via connected ducts

- Comfortable air conditioning of the entire factory by connecting a blow duct at the top of the indoor unit.

Note: Ducts to be procured locally.

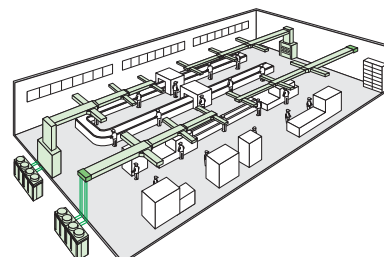





## ■ Extended operation range up to 49°C

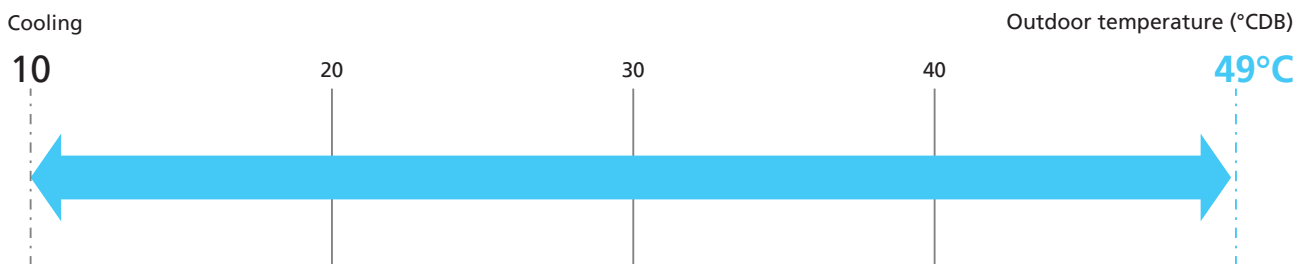

Note: When outdoor temperature falls below 10°C, the thermostat shuts OFF, the outdoor unit stops, and operation switches from cooling to fan operation.

# Design flexibility

## ■ Designed for long refrigerant piping

70 m maximum length and 50 m maximum level difference to cover medium- and large-scale building needs.

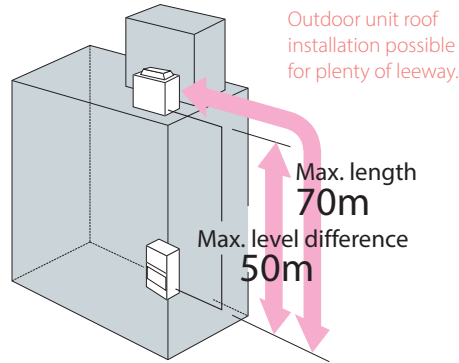

## ■ High external static pressure

The outdoor unit has been achieved high external static pressure up to 78.4 Pa, ensuring the efficient heat dissipation and stable operation of equipment in either hierarchical or intensive arrangement.



## ■ Nighttime quiet operation function

The nighttime quiet operation function automatically suppresses the nighttime operating sound by reducing operation capacity to maintain the quiet environment of the neighborhood. Three selectable modes are available depending on the required level.

\*1. Initial setting is 8 hours. Can be selected from 6, 8 and 10 hours.  
 \*2. Initial setting is 9 hours. Can be selected from 8, 9 and 10 hours.  
 \*3. In case of RZUR250PY1.

Notes: • This function is available in setting at site.  
 • The operating sound in quiet operation mode is the actual value measured by our company.  
 • The relationship of outdoor temperature (load) and time shown above is just an example.

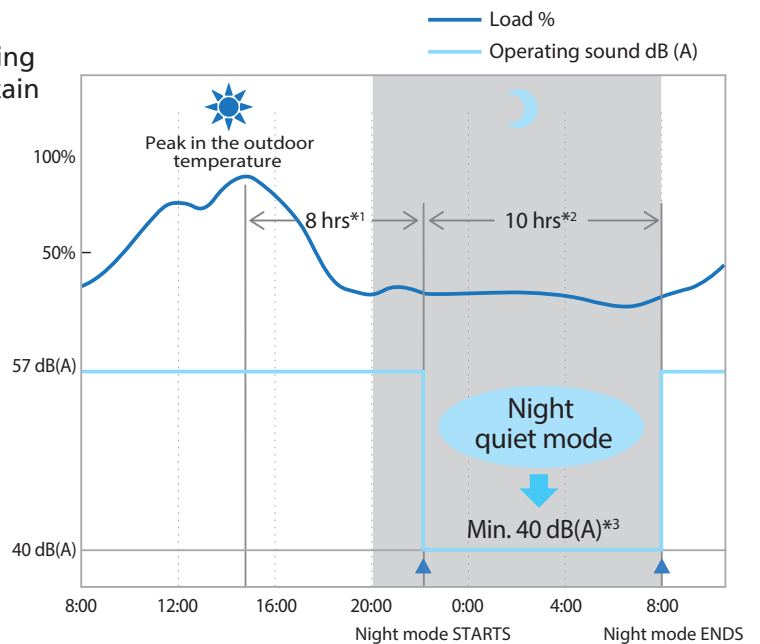

# Reliability

## Backup operation function

Compressor backup operation function

**Emergency operation**



**Malfunction**

\* For RZUR400/500PY1 models. On-site settings are required using the PCB of the outdoor unit.

## Centralized management system extension

Centralized management can integrate with D-BACS system with high speed data transfer. Centralized control is now available when using with Inverter packaged air conditioners. Display of air filter cleaning times and self-inspection function for simple maintenance.

High efficiency integrated control

### Intelligent Touch Manager

Lighting and ventilation control, energy use can be monitored and managed by one controller.



## Reliability, long life and premium efficiency motor

Reduce energy consumption, CO<sub>2</sub> emissions and the impact of industrial operations on the environment.

For FVPR-PY1G, FDR-PY1G



## Enhanced varieties of factory modification

○ Standard model  
□ Factory modification

Factory Modification	Floor Standing Type		Duct Type
	Direct Air Blow	Duct Connection	
Change fan motor and pulley	-	□	-
Discharge grill plenum chamber	○	□	-
Side discharge grill on discharge plenum chamber	□	□	-
Front suction high efficiency filter chamber	-	□	-
Front suction base flange for front suction high efficiency filter chamber	-	□	-
Suction grill for front suction high efficiency filter chamber	-	□	-
Rear suction	-	□	-
Drain pump	□	□	-
Change 2 blowers to reduce noise for direct flow	-	□*	-
2 step airflow by toggle switch	□	-	-

Note:  
\* For FVPR500PY1G only

# Specifications

## ■ FLOOR STANDING TYPE

### DIRECT AIR BLOW

Model Name	Indoor unit		FVGR200PV1		FVGR250PV1	
	Outdoor unit		RZUR200PY1		RZUR250PY1	
Cooling capacity*1 (Max.)	Btu/h		68,000 (74,000)		91,000 (96,000)	
	kW		20.0 (21.7)		26.7 (28.1)	
Power consumption*1	kW		7.25		9.64	
Indoor unit	Power supply		1 Phase, 220-240 V, 50 Hz			
	Colour		Ivory White			
	Air flow rate (H)	m <sup>3</sup> /min	80			
		cfm	2,830			
	Fan	Motor output	0.245×2			
		Drive	Direct Drive 3 Speed			
	Dimensions (H×W×D)	mm	1,870×1,170×510			
	Machine weight	kg	149			
	Sound level	dB(A)	61			
Drain	mm	PS 1B Internal thread				
Outdoor unit	Power supply		3 Phase, 380-415 V, 50 Hz			
	Colour		Ivory white			
	Compressor	Type	Hermetically sealed scroll type			
		Motor output	kW	3.4×1	4.5×1	
	Air flow rate (H)	m <sup>3</sup> /min	178			
	Dimensions (H×W×D)	mm	1,657×930×765			
	Machine weight	kg	175	185		
	Sound level*2	dB(A)	56	57		
	Operation range	°CDB	10 to 49			
Refrigerant charge	kg	5.9	6.7			
Refrigerant Piping	Liquid	mm	Ø 9.5 (Brazing)			
	Gas	mm	Ø 19.1 (Brazing)	Ø 22.2 (Brazing)		
Max. piping length	m	70 (equivalent length 90 m)				
Max. level difference	m	50				

## ■ FLOOR STANDING TYPE

### DUCT CONNECTION

Model Name	Indoor unit		FVPR250PY1G		FVPR400PY1G		FVPR500PY1G	
	Outdoor unit		RZUR250PY1		RZUR400PY1		RZUR500PY1	
Cooling capacity*1 (Max.)	Btu/h		91,000 (96,000)		136,000 (150,000)		171,000 (176,000)	
	kW		26.7 (28.1)		40.0 (44.0)		50.0 (51.6)	
Power consumption*1	kW		9.27		17.02		23.26	
Indoor unit	Power supply		3 Phase, 380-415 V, 50 Hz					
	Colour		Ivory White					
	Air flow rate (H)	m <sup>3</sup> /min	80		120		162	
		cfm	2,830		4,240		5,720	
	External static pressure*3	Pa	147		147		147	
	Fan	Motor output	1.5		2.2		3.7	
		Drive	Belt Drive					
	Dimensions (H×W×D)	mm	1,740×1,170×510		1,870×1,170×720		1,870×1,470×720	
	Machine weight	kg	160		210		254	
Sound level	dB(A)	61		62		63		
Drain	mm	PS 1B Internal thread						
Outdoor unit	Power supply		3 Phase, 380-415 V, 50 Hz					
	Colour		Ivory white					
	Compressor	Type	Hermetically sealed scroll type					
		Motor output	kW	4.5×1	(3.5×1)+(3.5×1)		(4.9×1)+(4.2×1)	
	Air flow rate (H)	m <sup>3</sup> /min	178		257		297	
	Dimensions (H×W×D)	mm	1,657×930×765		1,657×1,240×765			
	Machine weight	kg	185	260		291		
	Sound level*2	dB(A)	57	60		65		
	Operation range	°CDB	10 to 49					
Refrigerant charge	kg	6.7	8.2		11.7			
Refrigerant Piping	Liquid	mm	Ø 9.5 (Brazing)		Ø 12.7 (Brazing)		Ø 15.9 (Brazing)	
	Gas	mm	Ø 22.2 (Brazing)		Ø 28.6 (Brazing)			
Max. piping length	m	70 (equivalent length 90 m)						
Max. level difference	m	50						

Note :

\*1. Indoor temp.: 27°CDB, 19°CWB / outdoor temp.: 35°CDB / Equivalent piping length: 7.5 m, level difference: 0 m.

\*2. Anechoic chamber conversion value, measured at a point 1 m in front of the unit at a height of 1.5 m.

During actual operation, these values are normally somewhat higher as a result of ambient conditions and oil recovery mode.

When there is concern for noise the surrounding area such as residences, we recommend investigating the installation location and taking soundproofing measures.

\*3. The value is the external static pressure with standard pulley.

## DUCT TYPE

Model Name	Indoor unit		FDR200PY1G	FDR250PY1G	FDR400PY1G	FDR500PY1G	
	Outdoor unit		RZUR200PY1	RZUR250PY1	RZUR400PY1	RZUR500PY1	
Cooling capacity <sup>*1</sup> (Max.)	Btu/h		68,000 (74,000)	91,000 (96,000)	136,000 (150,000)	171,000 (176,000)	
	kW		20.0 (21.7)	26.7 (28.1)	40.0 (44.0)	50.0 (51.6)	
Power consumption <sup>*1</sup>	kW		8.06	10.39	17.86	26.74	
Indoor unit	Power supply		3 Phase, 380–415 V, 50 Hz				
	Colour		Galvanized Steel				
	Air flow rate (H)	m <sup>3</sup> /min		78		166	
		cfm		2,750		5,860	
	External static pressure <sup>*3</sup>		Pa	98		147	
	Fan	Motor output	kW	1.5		3.7	
		Drive		Belt drive			
	Dimensions (H×W×D)		mm	500×1,330×850		625×1,980×850	
	Machine weight		kg	112		200	
	Sound level		dB(A)	53		60	
Drain		mm	PS 3/4B Internal thread		PS 1B Internal thread		
Outdoor unit	Power supply		3 Phase, 380–415 V, 50 Hz				
	Colour		Ivory white				
	Compressor	Type	Hermetically sealed scroll type				
		Motor output	kW	3.4×1	4.5×1	(3.5×1)+(3.5×1)	(4.9×1)+(4.2×1)
	Air flow rate (H)	m <sup>3</sup> /min	178		257	297	
	Dimensions (H×W×D)		mm	1,657×930×765		1,657×1,240×765	
	Machine weight		kg	175	185	260	291
	Sound level <sup>*2</sup>		dB(A)	56	57	60	65
	Operation range		°CDB	10 to 49			
	Refrigerant charge		kg	5.9	6.7	8.2	11.7
Refrigerant Piping	Liquid	mm	Ø 9.5(Brazing)		Ø 12.7 (Brazing)	Ø 15.9 (Brazing)	
	Gas	mm	Ø 19.1 (Brazing)	Ø 22.2 (Brazing)	Ø 28.6 (Brazing)		
Max. piping length		m	70 (equivalent length 90 m)				
Max. level difference		m	50				

Note :

\*1. Indoor temp.: 27°CDB, 19°CWB / outdoor temp.: 35°CDB / Equivalent piping length: 7.5 m, level difference: 0 m.

\*2. Anechoic chamber conversion value, measured at a point 1 m in front of the unit at a height of 1.5 m.

During actual operation, these values are normally somewhat higher as a result of ambient conditions and oil recovery mode.

When there is concern for noise the surrounding area such as residences, we recommend investigating the installation location and taking soundproofing measures.

\*3. The value is the external static pressure with standard pulley.

## Option

### FLOOR STANDING TYPE

Option	Direct Air Blow	Duct Connection		
	FVGR-PV1	FVPR250PY1G	FVPR400PY1G	FVPR500PY1G
Discharge grill plenum chamber (Including pulley and belt)	—	BPCV10P	BPCV16P	BPCV20P
Filter chamber for clean room	—		•	

### CONTROL SYSTEM

Option	FVGR-PV1	FVPR-PY1G	FDR-PY1G
Simplified remote controller	—		BRC2E61
Navigator remote controller	—		BRC1E63
Wiring adaptor for electrical appendices (Group control adaptor)		KRP4AA51 ★	
Adaptor for wiring (operation status output)		BRP11B61	
Remote sensor (for indoor temperature)		BRCS01A-1	
Mounting plate for adaptor PCB	—		BRP45A ☆

Note :

Mounting plate ☆ is necessary for each adaptor marked ★.

# FAN PERFORMANCE

## FLOOR STANDING TYPE

### DUCT CONNECTION

**FVPR250PY1G**

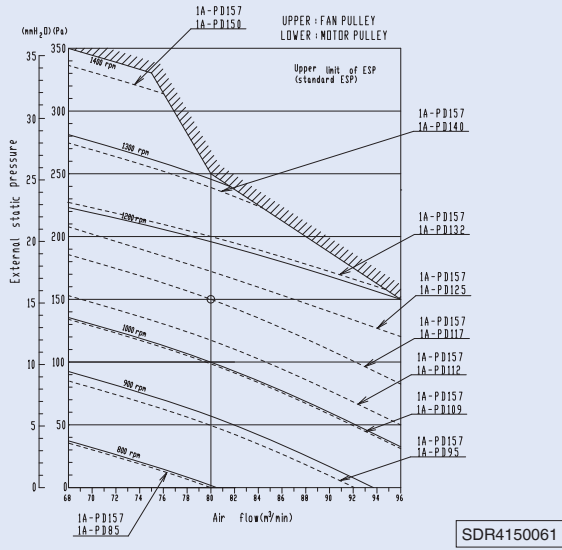

**FVPR400PY1G**

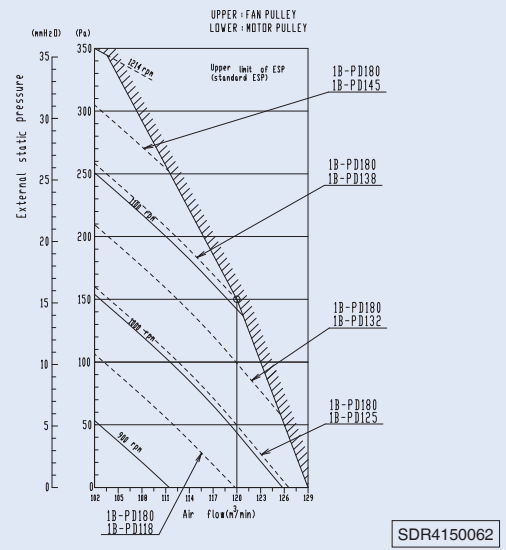

**FVPR500PY1G**

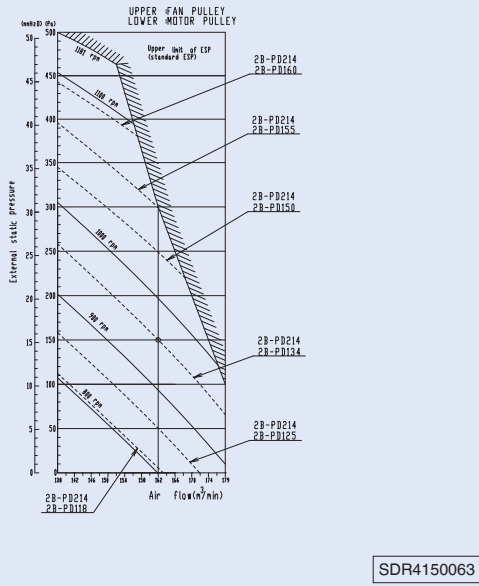



DUCT TYPE

FDR200PY1G  
FDR250PY1G

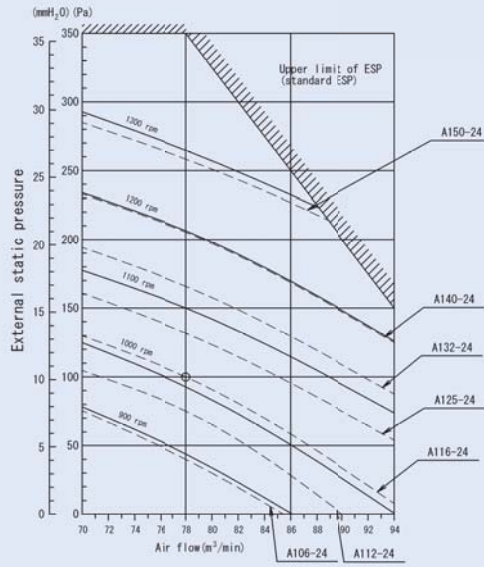

3D117526A

FDR400PY1G  
FDR500PY1G

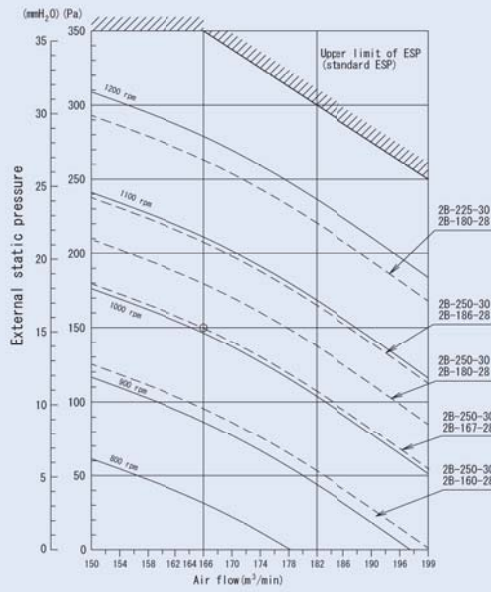

3D117527A

# Wiring Diagrams

## OUTDOOR UNIT

RZUR200PY1

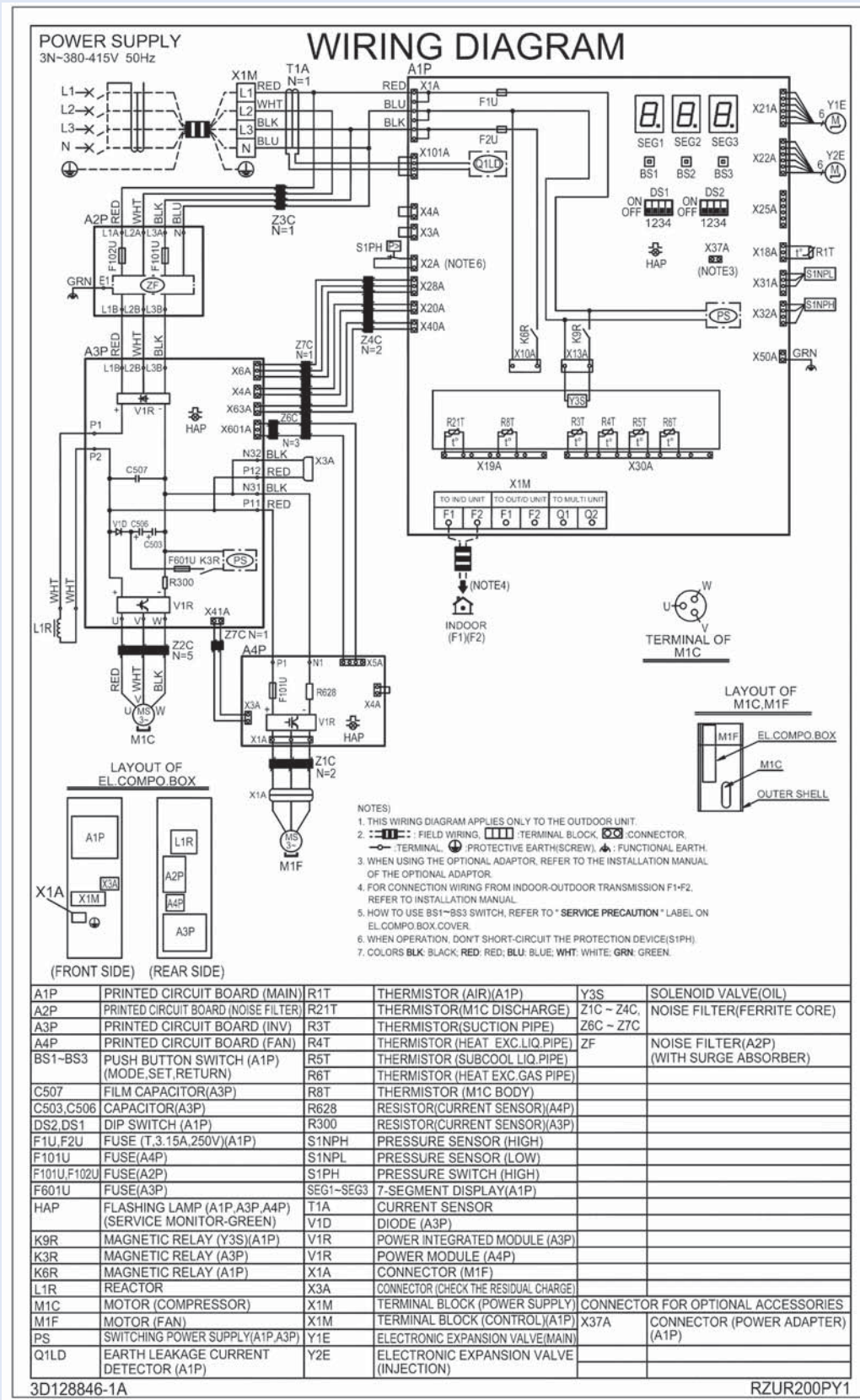

3D128846B

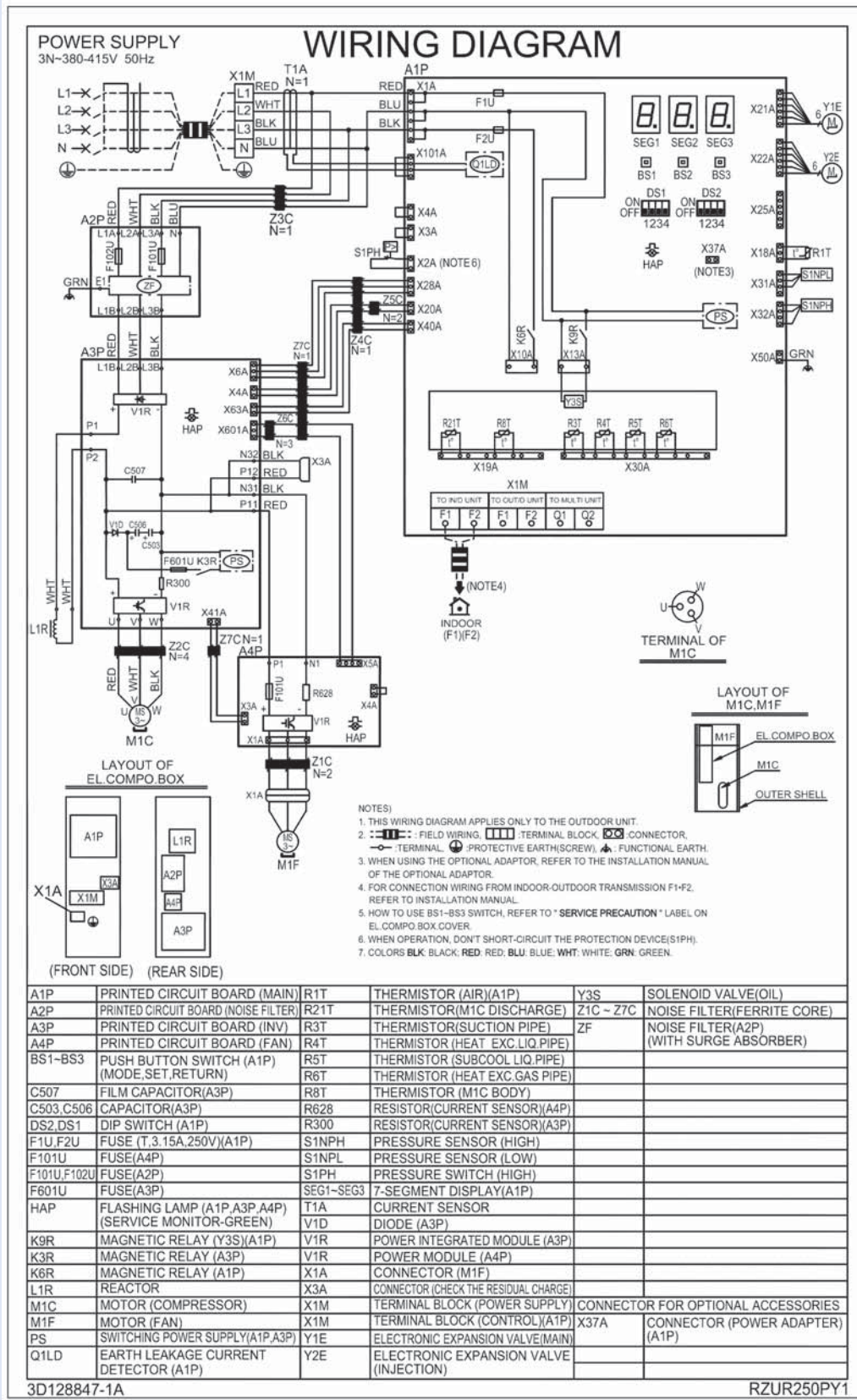



# Wiring Diagrams

RZR400PY1  
RZR500PY1

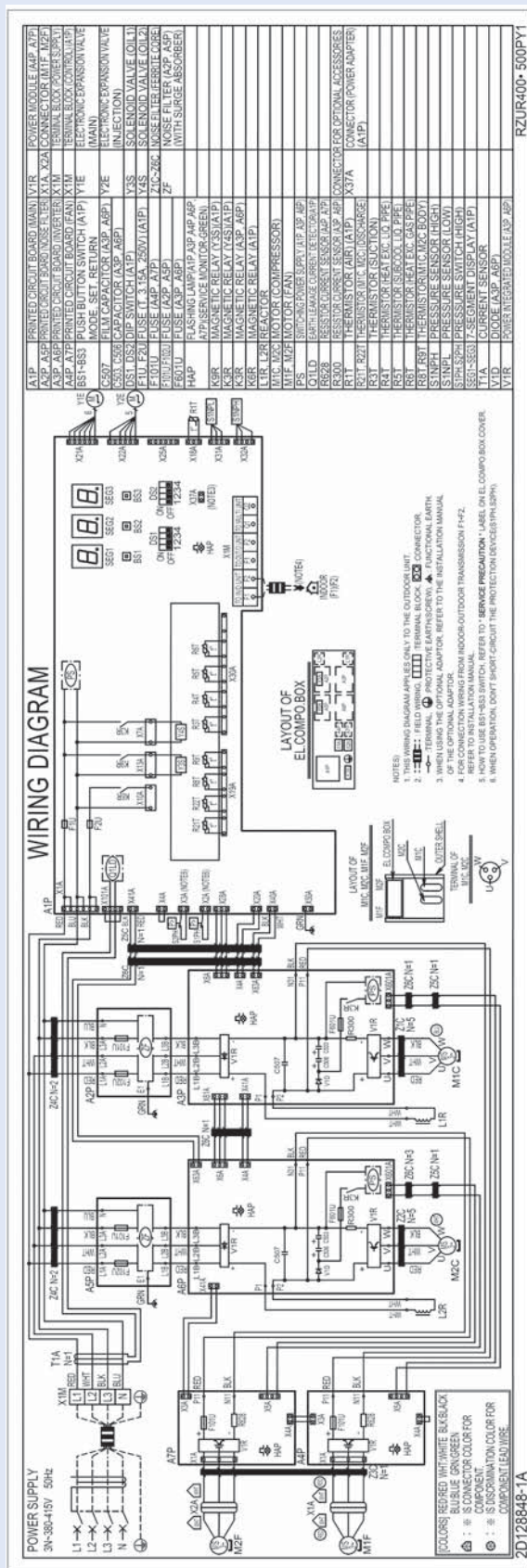

2D128848A



# Piping Diagrams

## OUTDOOR UNIT

RZUR200PY1  
RZUR250PY1

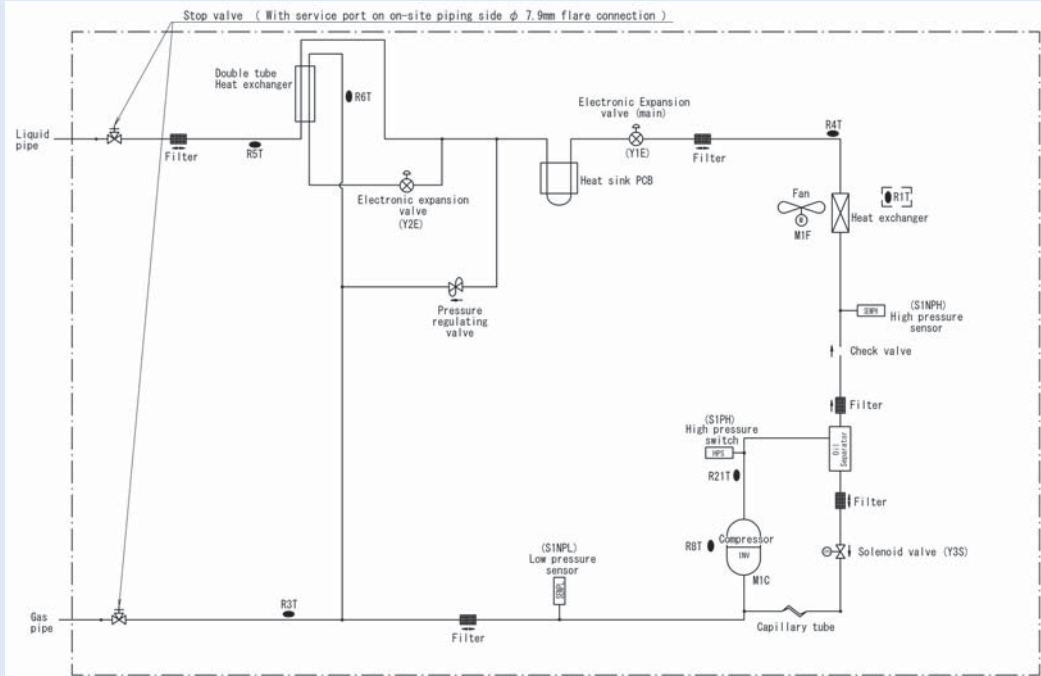

3D130368

RZUR400PY1  
RZUR500PY1

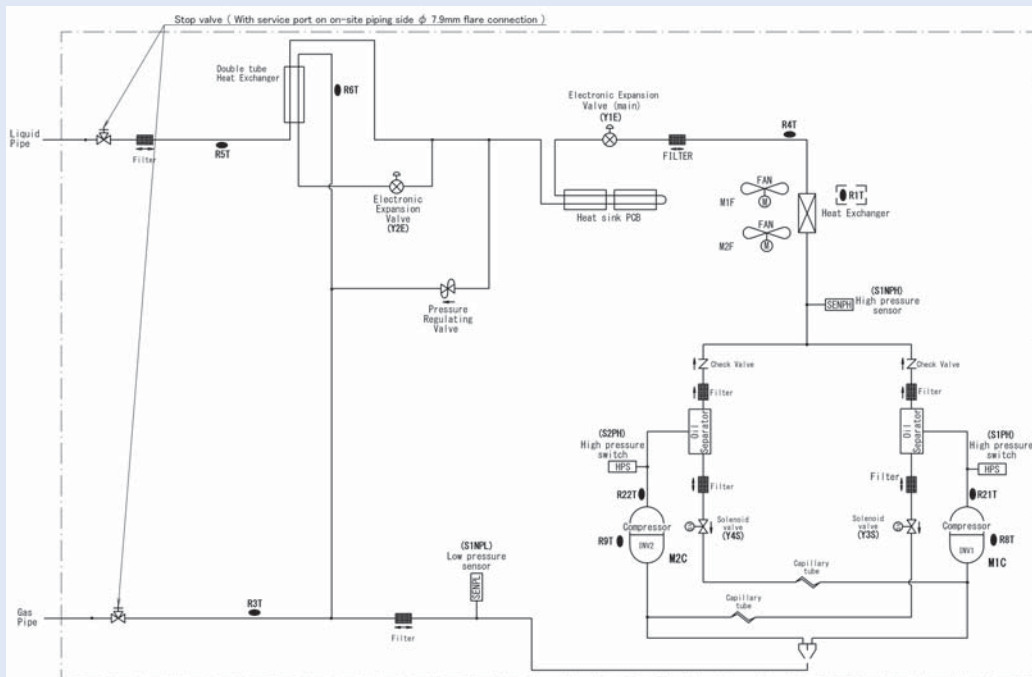

3D130373

# DIMENSIONS (Unit: mm)

## FLOOR STANDING TYPE

### DIRECT AIR BLOW

FVGR200PV1  
FVGR250PV1

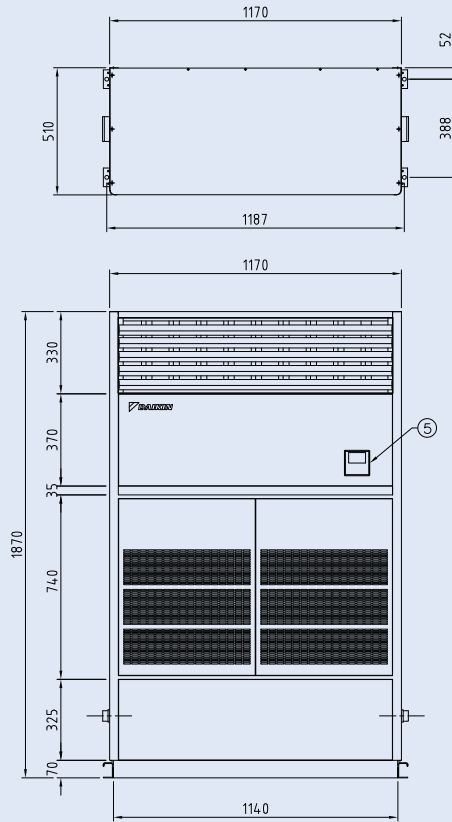

- ① Liquid pipe conn.  $\phi$  9.52 C1220T brazing
- ② Gas pipe conn.:  
 $\phi$  19.1 C1220T brazing for FVGR200PV1  
 $\phi$  22.2 C1220T brazing for FVGR250PV1
- ③ Upper drain outlet (PS 1B Internal thread)
- ④ Power supply & control wire intake
- ⑤ Digital remote controller

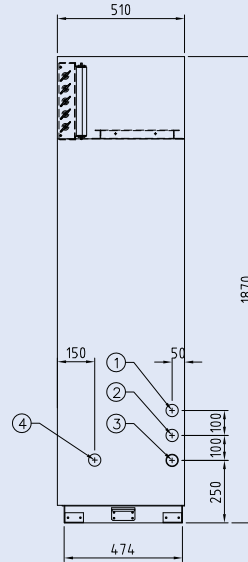

SDR3150202  
SDR3150203

### DUCT CONNECTION

FVPR250PY1G

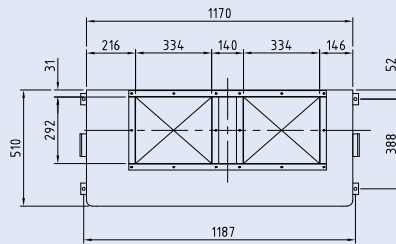

- ① LIQUID PIPE CONN.  $\phi$  9.52 C1220T BRAZING
- ② GAS PIPE CONN.  $\phi$  22.2 C1220T BRAZING
- ③ UPPER DRAIN OUTLET PS 1B INTERNAL THREAD
- ④ POWER SUPPLY & CONTROL WIRE INTAKE
- ⑤ DIGITAL REMOTE CONTROLLER

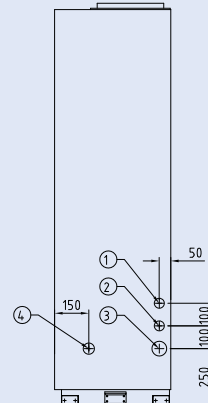
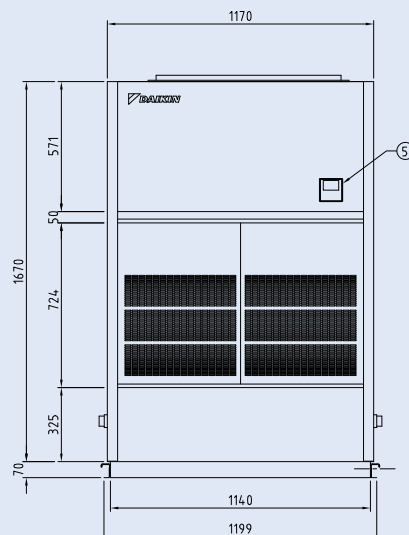
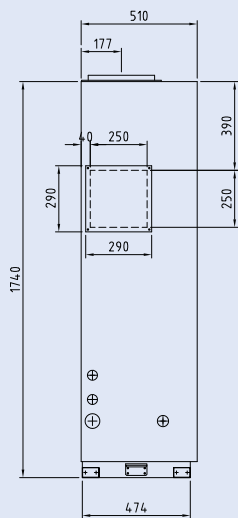

SDR3150204

**FVPR400PY1G**  
**FVPR500PY1G**

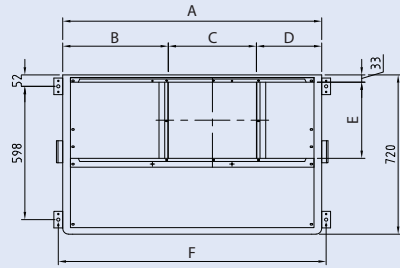

	A	B	C	D	E	F	G	H	J	K
FVPR400PY1G	1170	477	398	295	344	1187	1170	1144	205	∅12.7
FVPR500PY1G	1470	558	474	438	407	1487	1470	1444	237	∅15.9

- ① Liquid pipe conn. ( K ) C1220T brazing
- ② Gas pipe conn. ∅ 28.6 C1220T brazing
- ③ Upper drain outlet ( PS 1B Internal thread)
- ④ Power supply & control wire intake
- ⑤ Digital remote controller

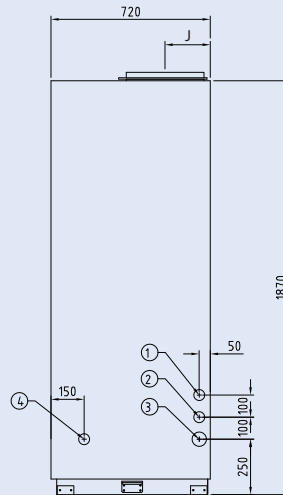
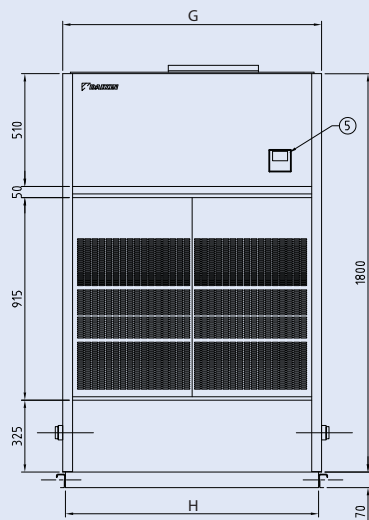

SDR3150205  
SDR3150206

# DIMENSIONS (Unit: mm)

## DUCT TYPE

FDR200PY1G  
FDR250PY1G

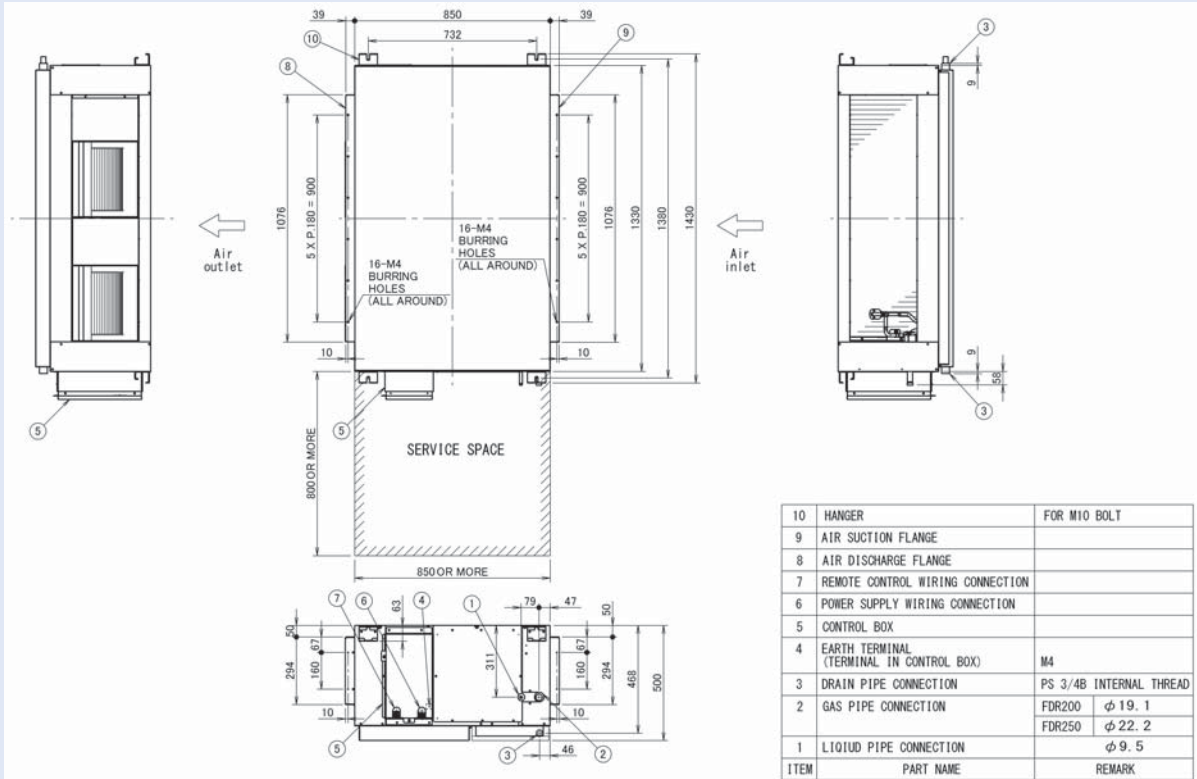

3D129097

FDR400PY1G  
FDR500PY1G

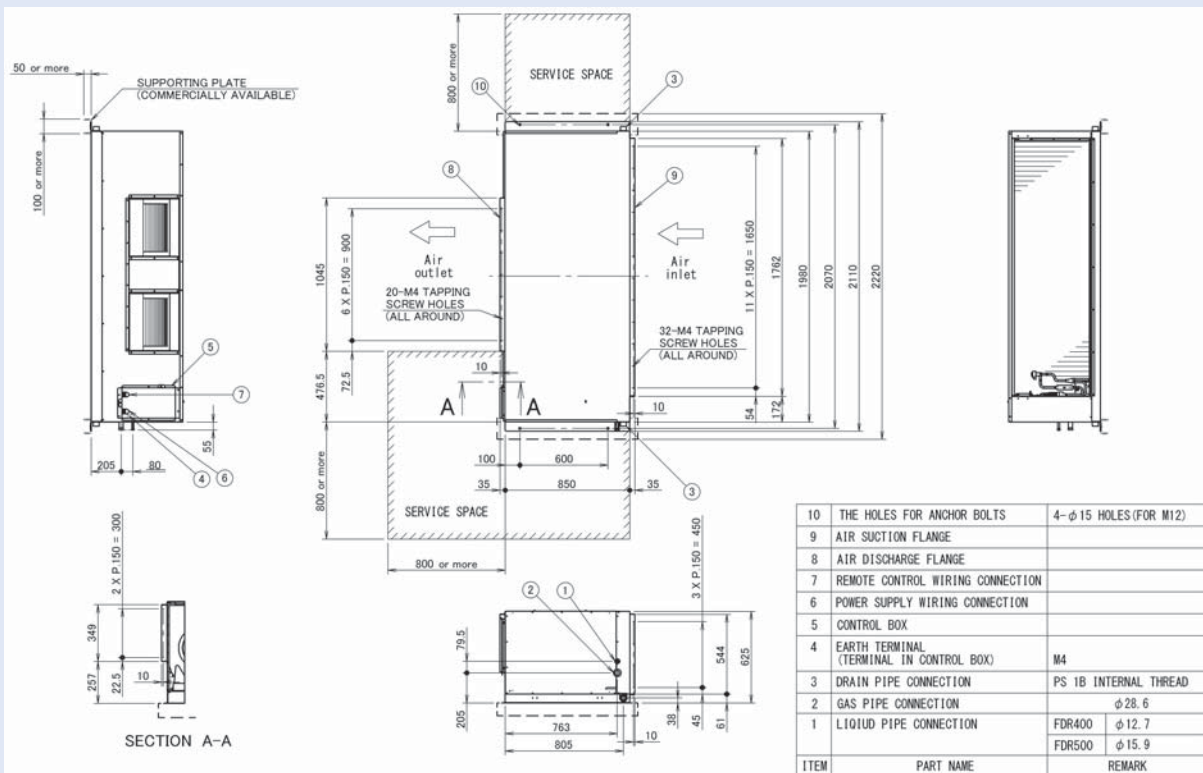

3D129107



# OUTDOOR UNIT

## RZUR200PY1 RZUR250PY1

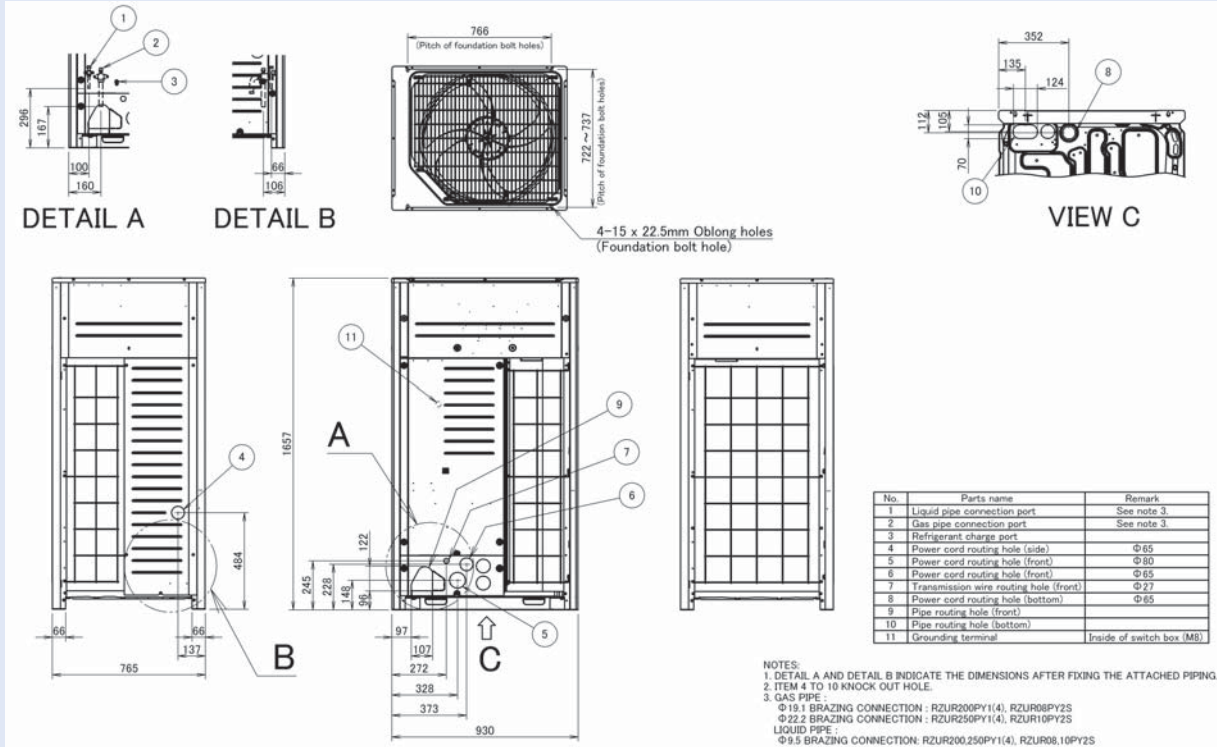

3D129057

## RZUR400PY1 RZUR500PY1

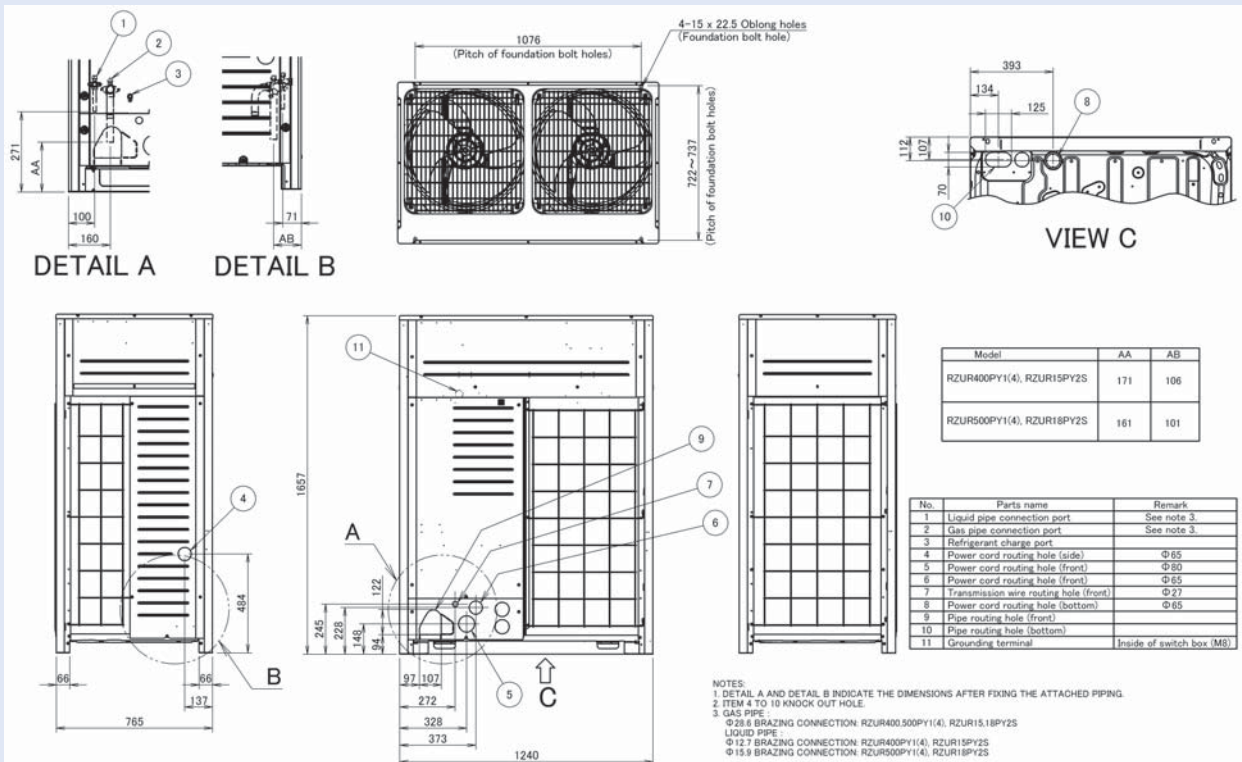

3D129058A

# Space required for indoor unit installation (Unit: mm)

**FVGR200PV1**  
**FVGR250PV1**

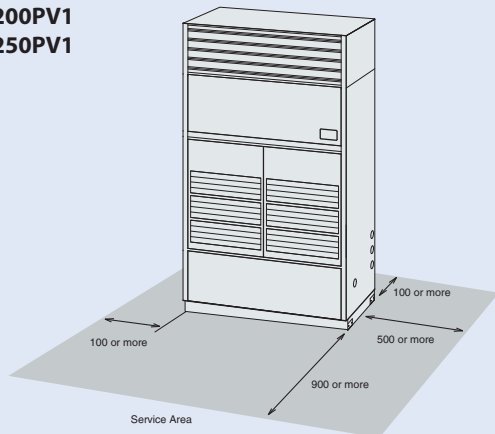

**FVPR250PY1G**  
**FVPR400PY1G**  
**FVPR500PY1G**

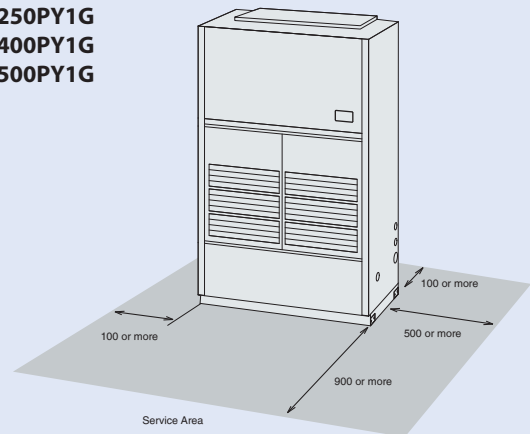

**FDR200PY1G**  
**FDR250PY1G**

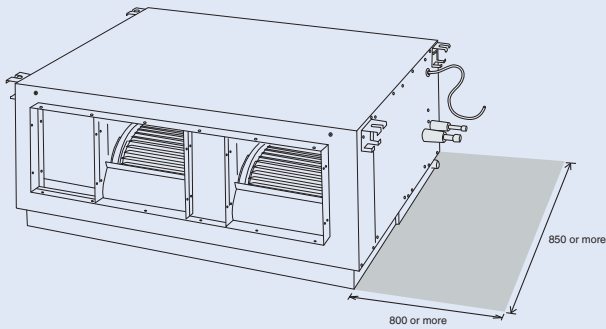

**FDR400PY1G**  
**FDR500PY1G**

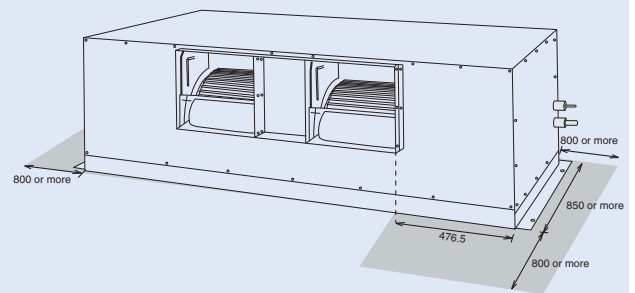

Provide enough clearance between the unit and the surrounding walls to prevent contact.

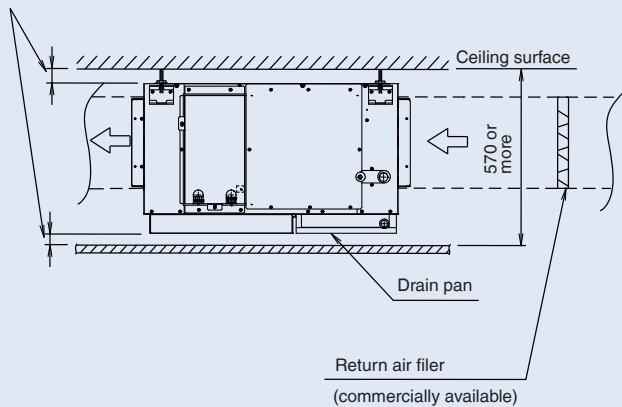

Provide enough clearance between the unit and the surrounding walls to prevent contact.

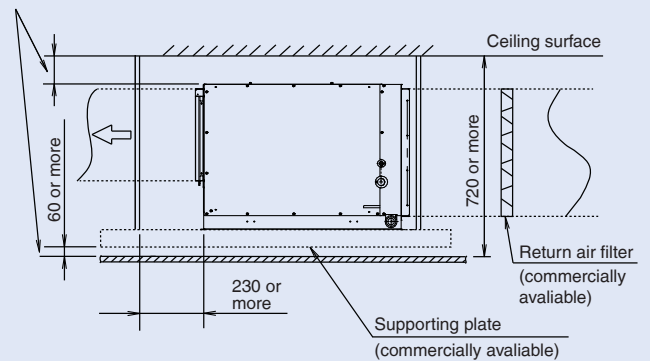

**For single unit installation**

**Pattern 1**

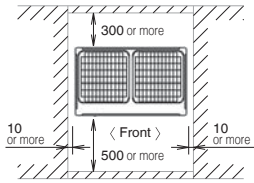

**Pattern 2**

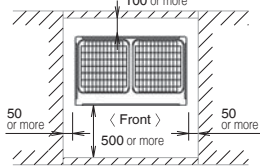

**Pattern 3**

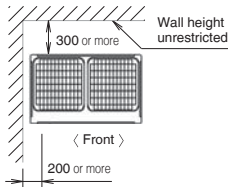

**For installation in rows**

**Pattern 1**

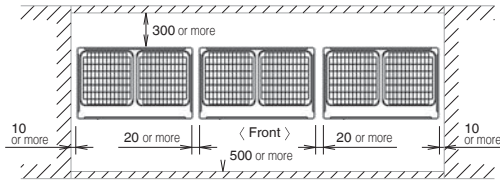

**Pattern 2**

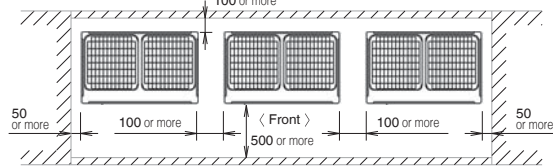

**Pattern 3**

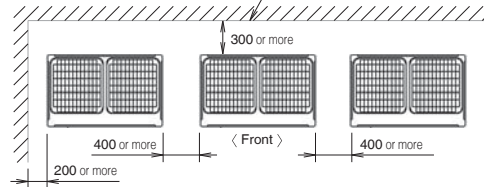

**For centralized group layout**

**Pattern 1**

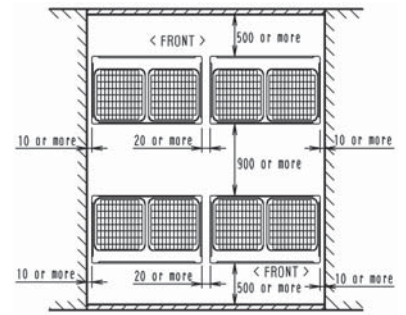
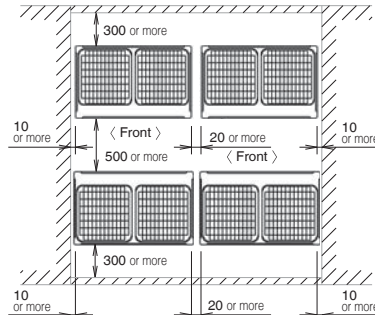
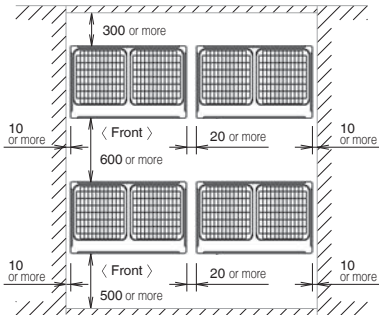

**Pattern 2**

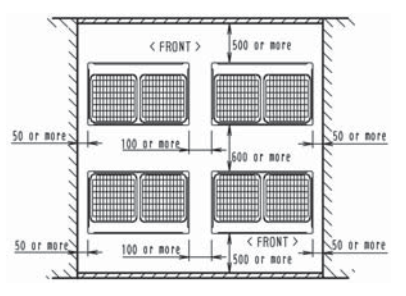
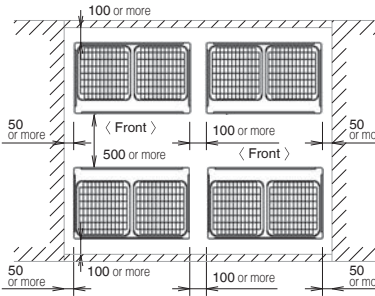
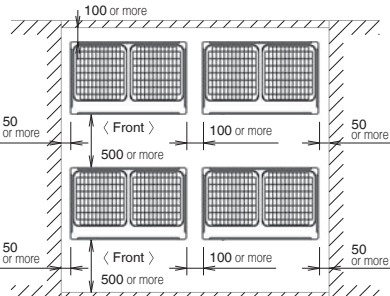

< Unit : mm >

**Notes:**

- Heights of walls in case of Patterns 1 and 2:  
Front : 1500 mm  
Suction side : 500 mm  
Side : Height unrestricted.

Installation space to be shown in this drawing is based on the cooling operation at 35 degrees outdoor air temperature. When the design outdoor air temperature exceeds 35 degrees or the load exceeds maximum ability because of much generation load of heat in all outdoor unit, take the suction side space more broadly than the space to be shown in this drawing.

- If the above wall heights are exceeded then h2/2 and h1/2 should be added to the front and suction side service spaces respectively as shown in the figure on the right.
- When installing the units most appropriate pattern should be selected from those shown above in order to obtain the best fit in the space available always bearing in mind the need to leave enough space for a person to pass between units and wall and for the air to circulate freely.  
( If more units are to be installed than are catered for in the above patterns )  
your layout should take account of the possibility of short circuits.
- The units should be installed to leave sufficient space at the front for the on site refrigerant piping work to be carried out comfortably.

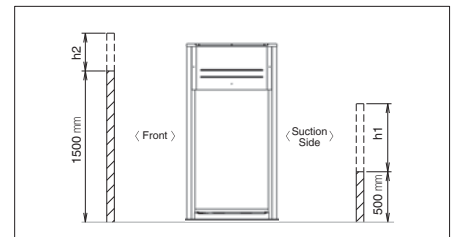



**Warning**



- Ask a qualified installer or contractor to install this product. Do not try to install the product yourself. Improper installation can result in water or refrigerant leakage, electrical shock, fire or explosion.
- Use only those parts and accessories supplied or specified by Daikin. Ask a qualified installer or contractor to install those parts and accessories. Use of unauthorised parts and accessories or improper installation of parts and accessories can result in water or refrigerant leakage, electrical shock, fire or explosion.
- Read the user's manual carefully before using this product. The user's manual provides important safety instructions and warnings. Be sure to follow these instructions and warnings.
- About harmonics, since this product is equipped with an inverter, harmonics will be generated. If local laws require the suppression of harmonics on the building, please take harmonic suppression measures on the electrical equipment side. Please contact your local sales company for details.

**Notice**



If you have any enquiries, please contact your local importer, distributor and/or retailer.

**Cautions on product corrosion**

1. Air conditioners should not be installed in areas where corrosive gases, such as acid gas or alkaline gas, are produced.
2. If the outdoor unit is to be installed close to the sea shore, direct exposure to the sea breeze should be avoided. If you need to install the outdoor unit close to the sea shore, contact your local distributor.

**Daikin Airconditioning (Singapore) Pte Ltd**

10 Ang Mo Kio Industrial Park 2, Singapore 569501

Tel: 6583 8888

Website: [www.daikin.com.sg](http://www.daikin.com.sg)

Find us on 

DAIKIN SINGAPORE 



[www.daikin.com.sg](http://www.daikin.com.sg)