



- Ask a qualified installer or contractor to install this product. Do not try to install the product yourself. Improper installation can result in water or refrigerant leakage, electrical shock, fire or explosion.
- Use only those parts and accessories supplied or specified by Daikin. Ask a qualified installer or contractor to install those parts and accessories. Use of unauthorised parts and accessories or improper installation of parts and accessories can result in water or refrigerant leakage, electrical shock, fire or explosion.
- Read the user's manual carefully before using this product. The user's manual provides important safety instructions and warnings. Be sure to follow these instructions and warnings.

If you have any enquiries, please contact your local importer, distributor and/or retailer.

Cautions on product corrosion

1. Air conditioners should not be installed in areas where corrosive gases, such as acid gas or alkaline gas, are produced.
2. If the outdoor unit is to be installed close to the sea shore, direct exposure to the sea breeze should be avoided. If you need to install the outdoor unit close to the sea shore, contact your local distributor.



PCVMT1536aprv



VRV IV

HEAT RECOVERY HOT WATER SYSTEM

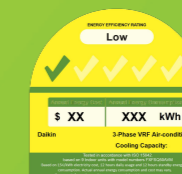

RWHQ14TYM
RWHQ16TYM
RWHQ18TYM
RWHQ20TYM



RWHQ6TYM
RWHQ8TYM
RWHQ10TYM
RWHQ12TYM

50 Hz **R-410A**

Comfortable air conditioning and energy-efficient hot water heating

This energy-efficient, multifunction system recovers waste heat generated by air conditioning, as energy to heat hot water.

CONTENTS

P.3 Main Features

P.9 Indoor Unit Lineup

P.11 Specifications-Outdoor Units

P.21 Specifications-Serpentine Heat Exchanger Unit

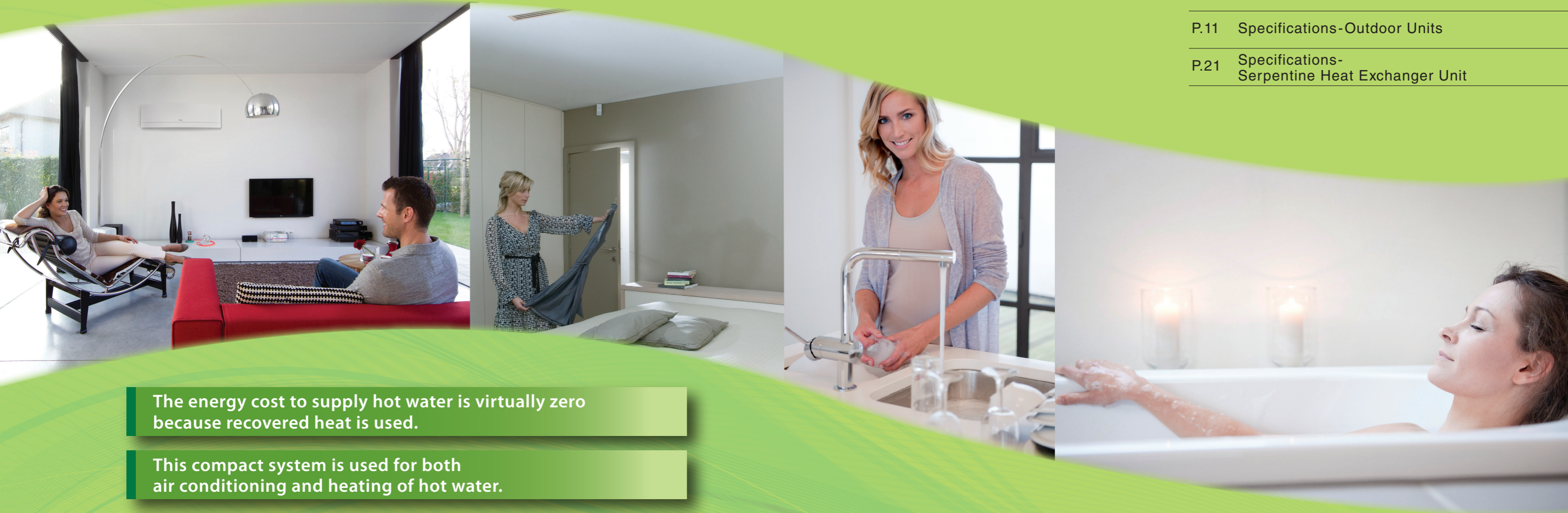

The energy cost to supply hot water is virtually zero because recovered heat is used.

This compact system is used for both air conditioning and heating of hot water.

Hot water of up to 65 °C can be supplied.

VRV IV

HEAT RECOVERY HOT WATER SYSTEM

Suitable for different business applications

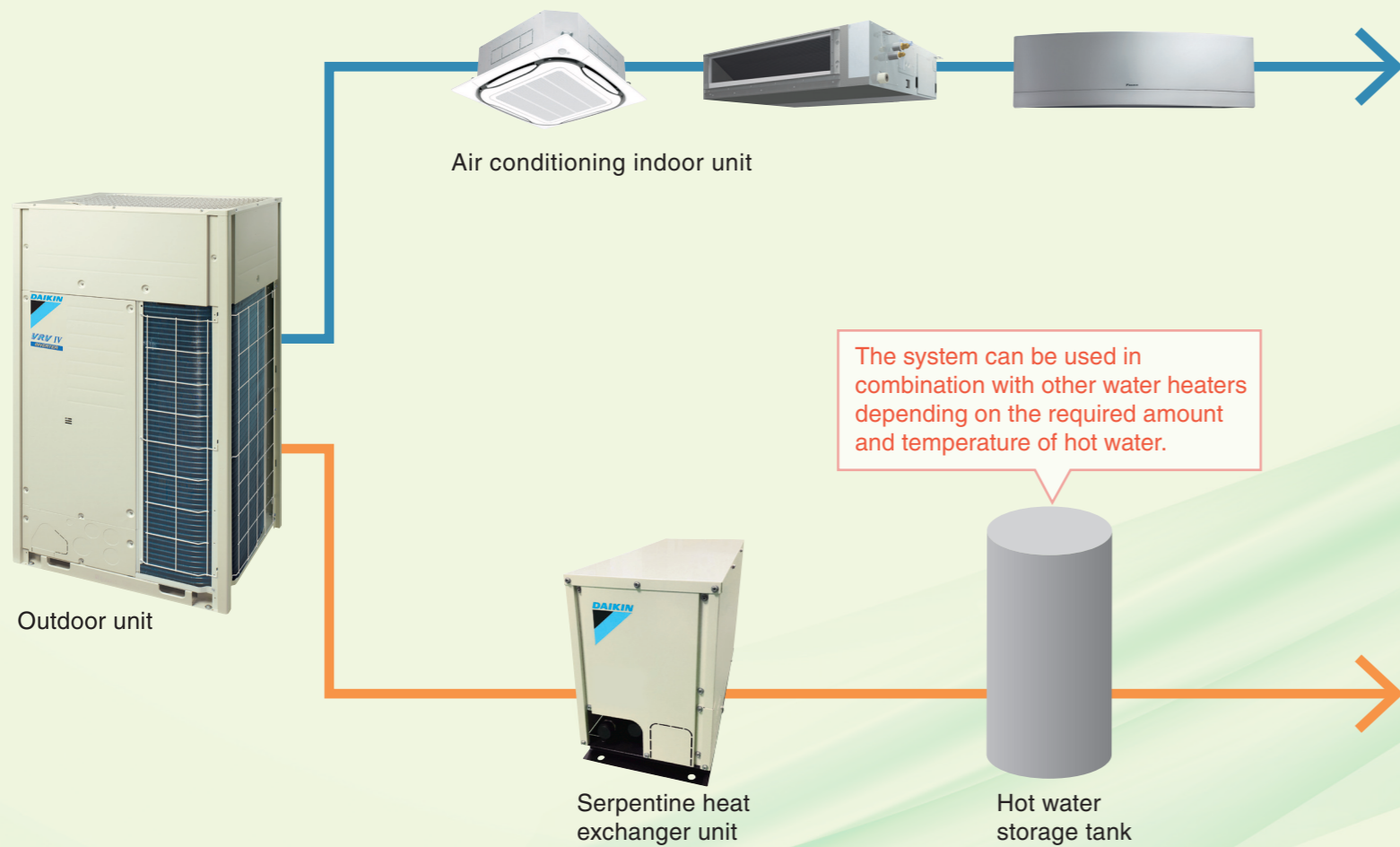

VRV IV HEAT RECOVERY HOT WATER SYSTEM

Flexible combination of VRV IV indoor units achieves comfort and aesthetic

AIR CONDITIONING



Extremely energy-efficient energy source

HOT WATER SUPPLY

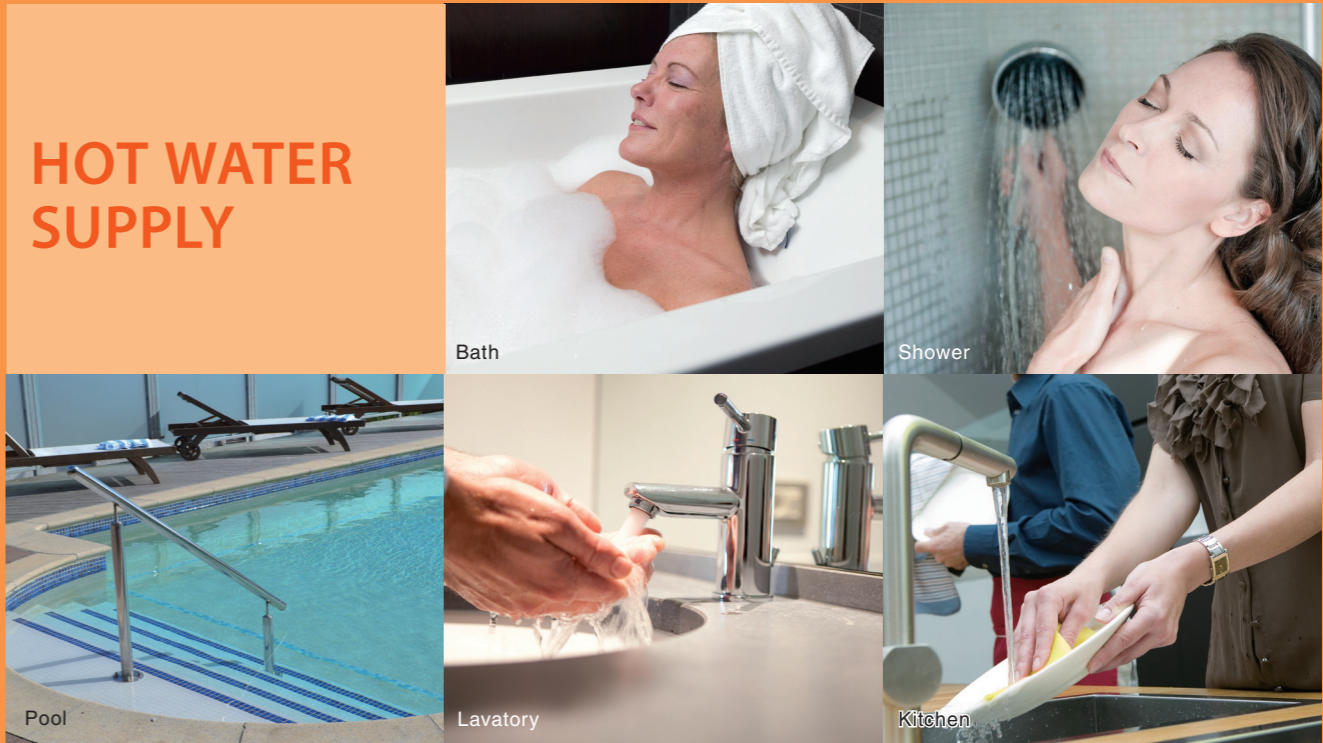

The energy-efficient system recovers waste heat as energy to heat hot water.

Waste heat from air conditioning (which usually released into the ambience) is recovered to heat water.

In a conventional system, waste heat from air conditioning is released into the ambience.

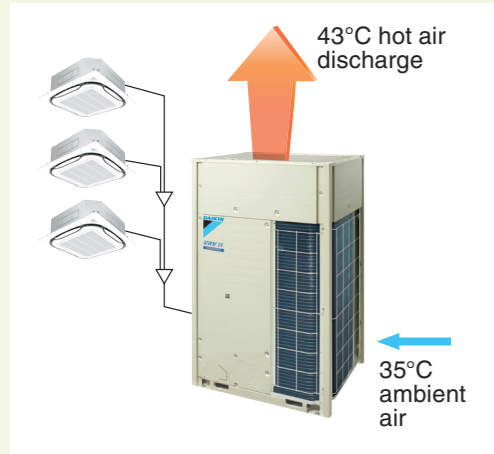

This system recovers waste heat from air conditioning to heat water.

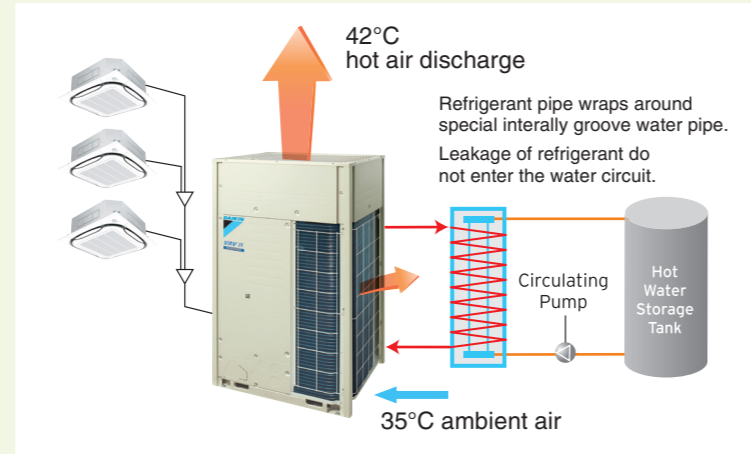

During the air conditioning operation, the refrigerant is compressed by a compressor into a high-temperature, high-pressure gas. The refrigerant is then fed into the heat exchanger for heat transfer to the circulating water.

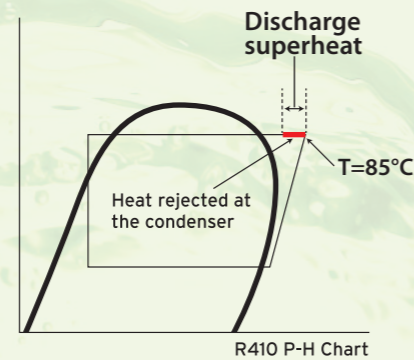

Air conditioning combined with hot water supply **Compact system**

Energy to supply hot water **Cost-effective**

Hot water temperature **Up to 65 °C**

Can be used in combination with other water heaters depending on the required amount and temperature of hot water.

The Serpentine Heat Exchanger Unit recovers heat.

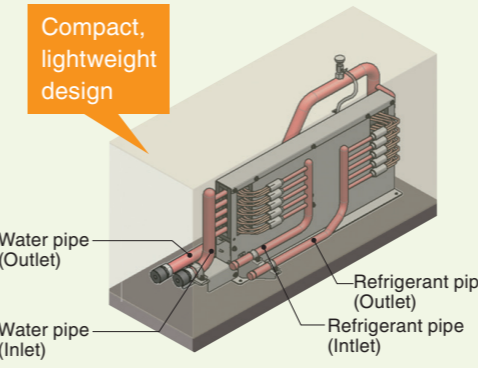

The proprietary Serpentine Heat Exchanger achieves excellent heat exchange efficiency.

The high-temperature, high-pressure refrigerant pipe is coiled around the water pipe.



Increased energy efficiency of the outdoor unit

The waste heat from air conditioning is transferred to heat water. This mechanism reduces the amount of heat processed by the outdoor unit, resulting in better operation efficiency.

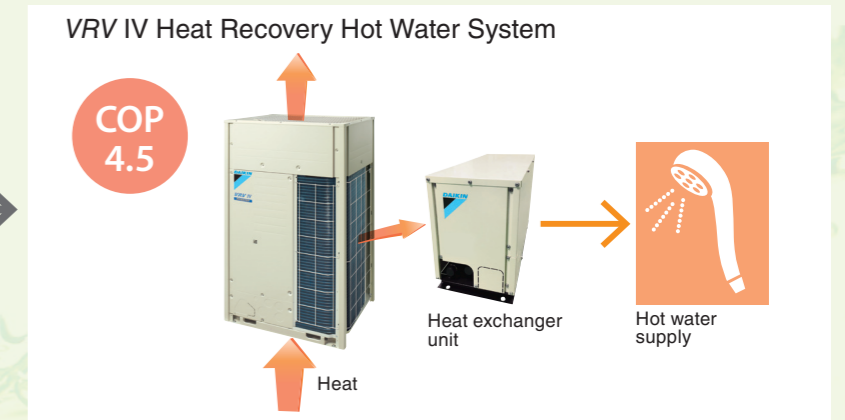
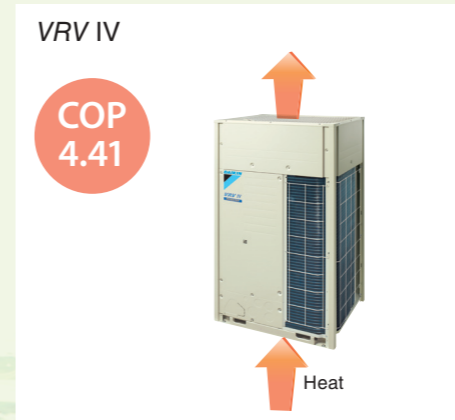

* Comparison of air conditioning using a 6 HP outdoor unit

Reducing short circuits

The temperature of exhaust heat from the outdoor unit is lower, minimising in ambient temperature increase. In the event of a short circuit, capacity reduction is minimised.

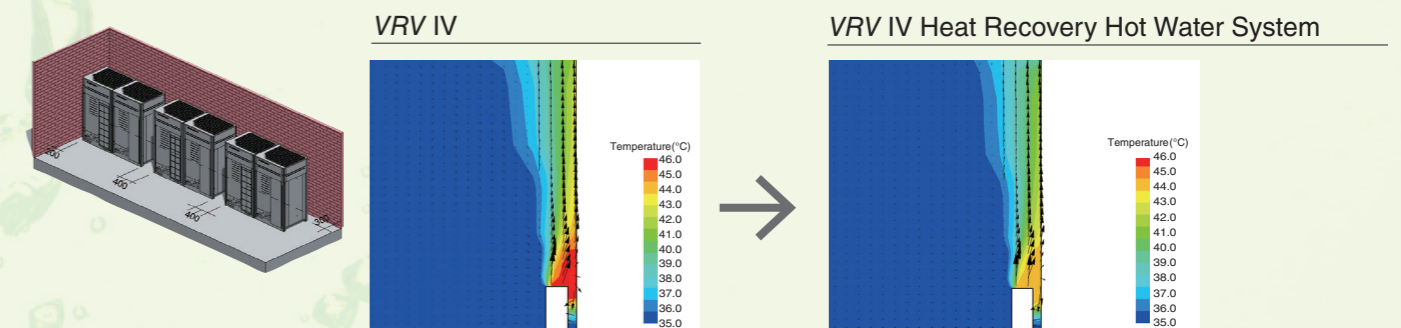

* Comparison of air conditioning using a 6 HP outdoor unit

Innovative and reliable system

Example on usage of VRV IV Heat Recovery Hot Water System for residence

In a sample family model of 3 adults and 3 children, the waste heat generated by air conditioning is sufficient to supply hot water for everybody's showers.

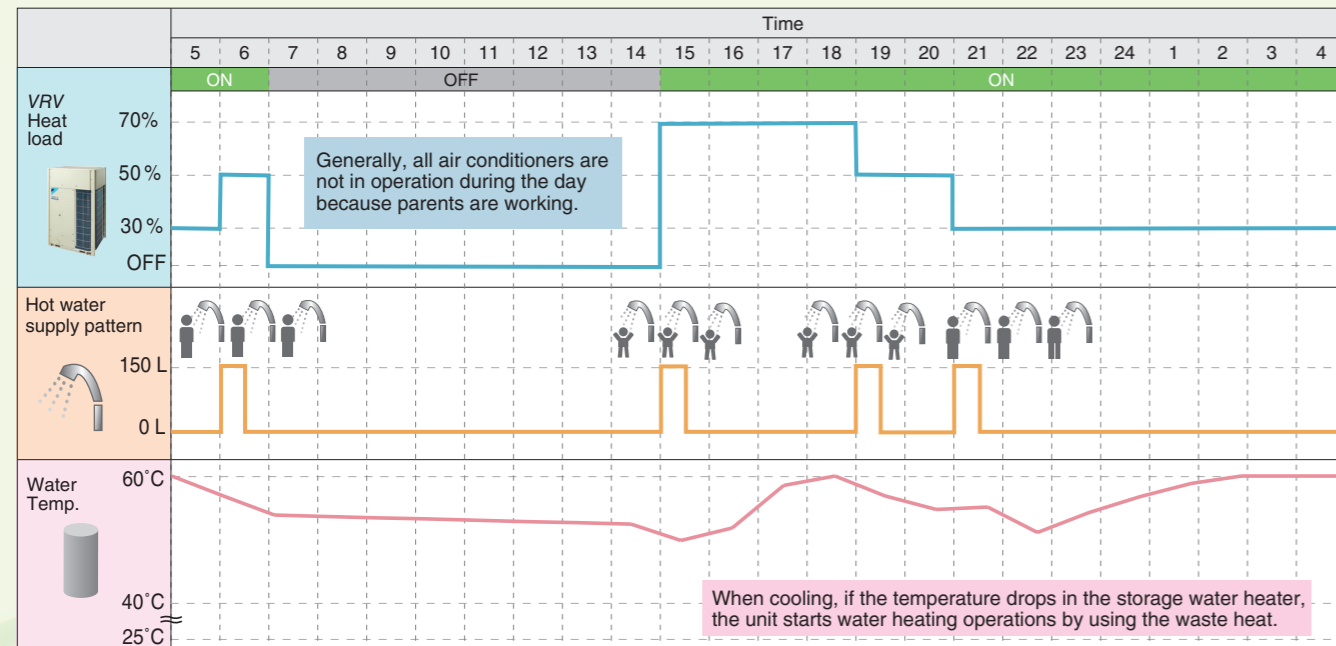
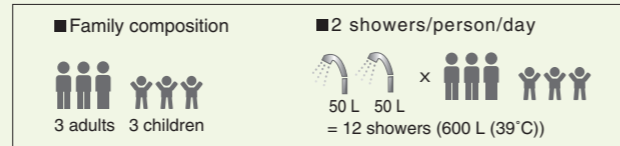

Air conditioner load conditions Operation time: 16 hours/day

Water-heating load
 Tank capacity: 200 L
 Boiling temperature: 25°C to 60°C (tap water)

Amount of hot water per person per time (standard): 50 L/shower (39°C) (water dispensed: 10 L/min.; shower time: 5 min./shower)
 Amount of water required in tank to dispense 39°C hot water

Comparison between VRV IV Heat Recovery Hot Water System and electric heater

Because waste heat is used to heat water, annual electricity consumption can be reduced approximately 94% compared with consumption for separate operation of air conditioning and an electric water heater.

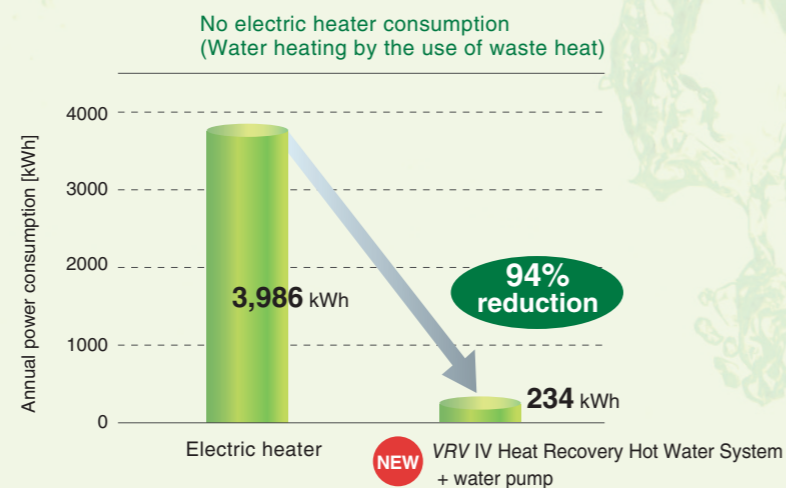

VRV IV Heat Recovery Hot Water Controller

Features

Convertible Remote Controller

Main Remote Control & Sub Remote Controller are both convertible and interchangeable.



Anti-Bacteria

By default, this would be activated every Monday morning at 2am, heating storage water up to 60°C for 10 minutes.

Vacation Mode

This disable all other functions, except for anti-bacterial mode.

Auto Restart

When power supply is restored after a failure, the system would revert to the last operational function.

Safety-Error Code

If thermistors or communication line are faulty, as a safety precaution, operation of the electric heater is disabled.

VRV IV Heat Recovery Hot Water System overview

Schematic Diagram For Residential Application

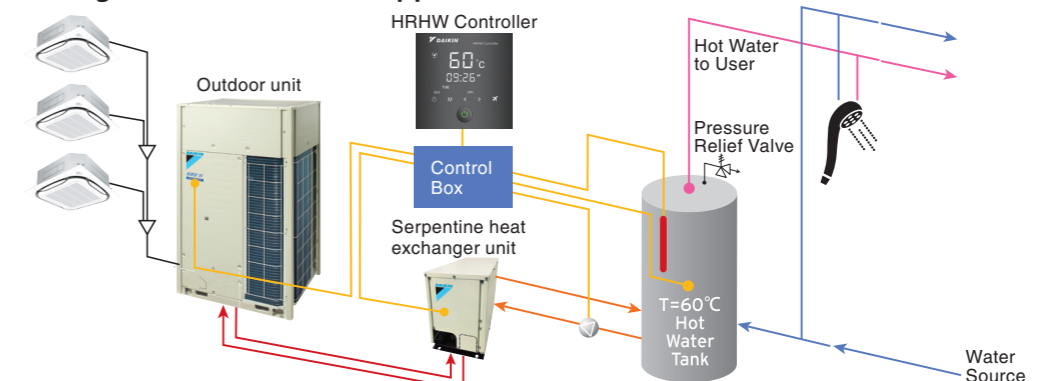

*Remarks: Electric heater is used for anti-bacterial mode as well as backup heater.

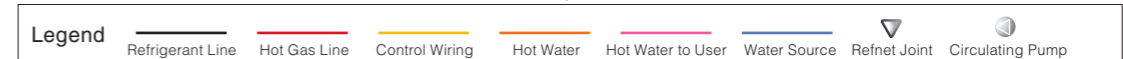

Schematic Diagram For Commercial Application

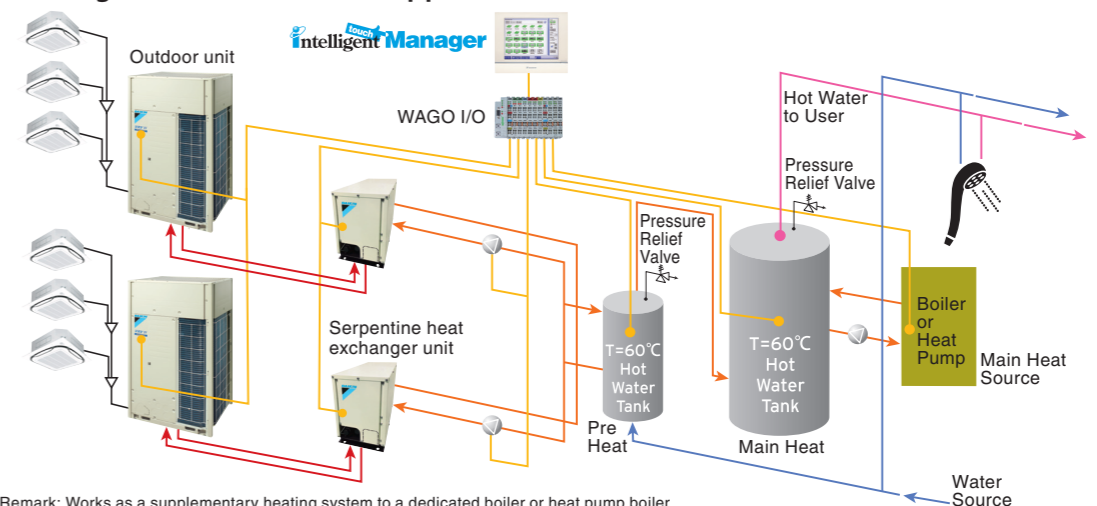

*Remark: Works as a supplementary heating system to a dedicated boiler or heat pump boiler.

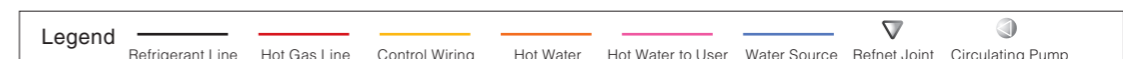

One of the Proposed Commercial Schematic Diagrams

Indoor Unit Lineup

Enhanced range of choices

A mixed of stylish and quiet VRV type indoor units and residential type indoor units can be combined into one system.

VRV indoor units

19 types 101 models

Type	Model Name	Capacity Range	20	25	32	40	50	63	71	80	100	125	140	200	250	400	500
			0.8HP	1HP	1.25HP	1.6HP	2HP	2.5HP	3HP	3.2HP	4HP	5HP	6HP	8HP	10HP	16HP	20HP
			Capacity Index	20	25	31.25	40	50	62.5	71	80	100	125	140	200	250	400
Ceiling Mounted Cassette(Round Flow with Sensing)	FXFQ-SVM			●	●	●	●	●		●	●	●					
Ceiling Mounted Cassette (Round Flow)	FXFQ-LUV1			●	●	●	●	●		●	●	●					
Ceiling Mounted Cassette (Compact Multi Flow)	FXZQ-MVE		●	●	●	●	●										
Ceiling Mounted Cassette (Double Flow)	FXCQ-MVE		●	●	●	●	●	●		●		●					
Ceiling Mounted Cassette Corner	FXKQ-MAVE			●	●	●		●									
Slim Ceiling Mounted Duct (Standard Series)	FXDQ-PBVE (with drain pump)		●	●	●												
	FXDQ-PBVET (700 mm width type) (without drain pump)		●	●	●												
	FXDQ-NBVE (with drain pump)					●	●	●									
	FXDQ-NBVET (900/1,100 mm width type) (without drain pump)					●	●	●									
Slim Ceiling Mounted Duct (Compact Series)	FXDQ-SPV1		●	●	●	●	●	●									
Middle Static Pressure Ceiling Mounted Duct	FXSQ-PVE		●	●	●	●	●	●		●	●	●	●				
Ceiling Mounted Duct	FXMQ-PVE		●	●	●	●	●	●		●	●	●	●				
	FXMQ-MAVE													●	●		
4-Way Flow Ceiling Suspended	FXUQ-AVEB								●		●						
Ceiling Suspended	FXHQ-MAVE				●			●			●						
Wall Mounted	FXAQ-PVE		●	●	●	●	●	●									
Floor Standing	FXLQ-MAVE		●	●	●	●	●	●									
Concealed Floor Standing	FXNQ-MAVE		●	●	●	●	●	●									
Floor Standing Duct	FXVQ-NY1											●		●	●	●	●

Residential indoor units with connection to BP units

7 types 18 models

Type	Model Name	Rated Capacity (kW)	25	35	50	60	71
			2.5	3.5	5.0	6.0	7.1
			Capacity Index	25	35	50	60
Slim Ceiling Mounted Duct	FDKS-EAVMB		●	●			
	FDKS-C(A)VMB		●	●	●	●	
Wall Mounted	FTKJ-NVMW		●	●	●		
	FTKJ-NVMS		●	●	●		
	FTKS-DVM		●	●			
	FTKS-BVMA				●		
	FTKS-FVM				●	●	●





Note: BP units (BPMKS967A2/3) are necessary for residential indoor units.

*Some model names might differ and some products might not be available depending on the country of sale. For further information, please contact one of our sales companies.

Specifications

Outdoor Units

High-COP Type

																			
MODEL			RWHQ12THY1	RWHQ14THY1	RWHQ16THY1	RWHQ18THY1	RWHQ20THY1	RWHQ22THY1	RWHQ24THY1	RWHQ26THY1	RWHQ28THY1	RWHQ30THY1	RWHQ32THY1	RWHQ34THY1	RWHQ36THY1	RWHQ38THY1	RWHQ40THY1		
Combination units			RWHQ6TY1	RWHQ6TY1	RWHQ8TY1	RWHQ6TY1	RWHQ6TY1	RWHQ6TY1	RWHQ8TY1	RWHQ8TY1	RWHQ8TY1	RWHQ8TY1	RWHQ8TY1	RWHQ8TY1	RWHQ8TY1	RWHQ12TY1	RWHQ12TY1		
			RWHQ6TY1	RWHQ8TY1	RWHQ8TY1	RWHQ6TY1	RWHQ6TY1	RWHQ8TY1	RWHQ8TY1	RWHQ10TY1	RWHQ12TY1	RWHQ12TY1	RWHQ12TY1	RWHQ14TY1	RWHQ14TY1	RWHQ14TY1	RWHQ14TY1		
Power supply			3-phase 4-wire system, 380–415 V, 50 Hz								3-phase 4-wire system, 380–415 V, 50 Hz								
Cooling capacity		kcal/h	27,500	33,000	38,500	41,300	46,800	52,300	57,800	62,600	67,300	72,200	76,900	82,500	87,700	92,000	98,000		
		Btu/h	109,000	131,000	153,000	164,000	186,000	207,000	229,000	248,000	267,000	286,000	305,000	327,000	348,000	365,000	389,000		
		kW	32.0	38.4	44.8	48.0	54.4	60.8	67.2	72.8	78.3	83.9	89.4	95.9	102	107	114		
Power consumption		kW	7.10	8.68	10.3	10.7	12.2	13.8	15.4	17.5	19.2	21.3	23.0	24.9	26.7	28.7	30.5		
Capacity control		%	10-100	10-100	10-100	7-100	7-100	7-100	7-100	6-100	6-100	5-100	5-100	5-100	4-100	4-100	4-100		
Casing colour			Ivory white (5Y7.5/1)								Ivory white (5Y7.5/1)								
Compressor			Hermetically Sealed Scroll Type								Hermetically Sealed Scroll Type								
Type																			
Motor output	kW	(2.4X1)+ (2.4X1)	(2.4X1)+ (3.4X1)	(3.4X1)+ (3.4X1)	(2.4X1)+ (2.4X1)	(2.4X1)+ (2.4X1)	(2.4X1)+ (3.4X1)	(2.4X1)+ (3.4X1)	(3.4X1)+ (3.4X1)	(3.4X1)+ (4.1X1)	(3.4X1)+ (3.4X1)	(3.4X1)+ (4.1X1)	(3.4X1)+ (5.2X1)	(3.4X1)+ (5.2X1)	(3.4X1)+(2.9X1)+ (2.9X1)+(3.3X1)	(3.4X1)+(2.9X1)+ (3.3X1)+(2.9X1)+ (3.3X1)	(5.2X1)+(5.2X1)+ (2.9X1)+(3.3X1)	(5.2X1)+(2.9X1)+ (3.3X1)+(2.9X1)+ (3.3X1)	
Airflow rate		m ³ /min	119+119	119+157	157+157	119+119+119	119+119+157	119+157+157	157+157+157	157+157+165	157+157+178	157+165+178	157+178+178	157+178+233	157+233+233	178+178+233	178+233+233		
Dimensions (HxWxD)		mm	(1,657x930x765)+ (1,657x930x765)	(1,657x930x765)+ (1,657x930x765)	(1,657x930x765)+ (1,657x930x765)	(1,657x930x765)+ (1,657x930x765)	(1,657x930x765)+ (1,657x930x765)	(1,657x930x765)+ (1,657x930x765)	(1,657x930x765)+ (1,657x930x765)	(1,657x930x765)+ (1,657x930x765)	(1,657x930x765)+ (1,657x930x765)	(1,657x930x765)+ (1,657x930x765)	(1,657x930x765)+ (1,657x930x765)	(1,657x930x765)+ (1,657x1,240x765)	(1,657x930x765)+ (1,657x1,240x765)	(1,657x930x765)+ (1,657x1,240x765)	(1,657x930x765)+ (1,657x1,240x765)		
Machine weight		kg	185+185	185+185	185+185	185+185+185	185+185+185	185+185+185	185+185+185	185+185+200	185+185+200	185+200+200	185+200+200	185+200+285	185+285+285	200+200+285	200+285+285		
Sound level		dB(A)	58	59	59	60	60	60	61	61	62	62	63	63	64	64	64		
Operation range		°CDB	15 to 49								15 to 49								
Refrigerant		Type	R-410A																
		Charge	kg	6.4+6.4	6.4+6.4	6.4+6.4	6.4+6.4+6.4	6.4+6.4+6.4	6.4+6.4+6.4	6.4+6.4+6.5	6.4+6.4+6.8	6.4+6.5+6.8	6.4+6.8+6.8	6.4+6.8+10.3	6.4+10.3+10.3	6.8+6.8+10.3	6.8+10.3+10.3		
Piping connections (Indoor unit)		Liquid	mm	φ12.7 (Brazing)	φ12.7 (Brazing)	φ12.7 (Brazing)	φ15.9 (Brazing)	φ15.9 (Brazing)	φ15.9 (Brazing)	φ15.9 (Brazing)	φ19.1 (Brazing)	φ19.1 (Brazing)	φ19.1 (Brazing)	φ19.1 (Brazing)	φ19.1 (Brazing)	φ19.1 (Brazing)	φ19.1 (Brazing)		
		Gas	mm	φ28.6 (Brazing)	φ28.6 (Brazing)	φ28.6 (Brazing)	φ28.6 (Brazing)	φ28.6 (Brazing)	φ28.6 (Brazing)	φ34.9 (Brazing)	φ34.9 (Brazing)	φ34.9 (Brazing)	φ34.9 (Brazing)	φ34.9 (Brazing)	φ34.9 (Brazing)	φ41.3 (Brazing)	φ41.3 (Brazing)	φ41.3 (Brazing)	
Piping connections (Heat exchanger unit)		Inlet pipe	mm	φ19.1(Brazing)								φ19.1(Brazing)							
		Outlet pipe	mm	φ19.1(Brazing)								φ19.1(Brazing)							

Note: Specifications are based on the following conditions:

•Cooling: Indoor temp.: 27°CDB, 19°CWB, Outdoor temp.: 35°CDB, Equivalent piping length: 7.5 m, Level difference: 0 m.

•Sound level: Anechoic chamber conversion value, measured at a point 1 m in front of the unit at a height of 1.5 m.

During actual operation, these values are normally somewhat higher as a result of ambient conditions.

Specifications

Outdoor Units

High-COP Type



MODEL	RWHQ42THY1	RWHQ44THY1	RWHQ46THY1	RWHQ48THY1	RWHQ50THY1		
Combination units	RWHQ14TY1	RWHQ14TY1	RWHQ14TY1	RWHQ16TY1	RWHQ16TY1		
	RWHQ14TY1	RWHQ14TY1	RWHQ16TY1	RWHQ16TY1	RWHQ16TY1		
	RWHQ14TY1	RWHQ16TY1	RWHQ16TY1	RWHQ16TY1	RWHQ18TY1		
Power supply	3-phase 4-wire system, 380–415 V, 50 Hz						
Cooling capacity	kcal/h	103,000	108,000	112,000	116,000	120,000	
	Btu/h	409,000	427,000	444,000	461,000	478,000	
	kW	120	125	130	135	140	
Power consumption	kW	32.4	34.5	36.6	38.7	41.1	
Capacity control	%	4-100	3-100	3-100	3-100	3-100	
Casing colour	Ivory white (5Y7.5/1)						
Compressor	Type	Hermetically Sealed Scroll Type					
	Motor output	kW	(2.9X1)+(3.3X1)+ (2.9X1)+(3.3X1)+ (2.9X1)+(3.3X1)	(2.9X1)+(3.3X1)+ (2.9X1)+(3.3X1)+ (3.6X1)+(3.7X1)	(2.9X1)+(3.3X1)+ (3.6X1)+(3.7X1)+ (3.6X1)+(3.7X1)	(3.6X1)+(3.7X1)+ (3.6X1)+(3.7X1)+ (3.6X1)+(3.7X1)	(3.6X1)+(3.7X1)+ (3.6X1)+(3.7X1)+ (4.4X1)+(4.0X1)
Airflow rate	m ³ /min	233+233+233	233+233+233	233+233+233	233+233+233	233+233+233	
Dimensions (HxWxD)	mm	(1,657X1,240X765)+ (1,657X1,240X765)+ (1,657X1,240X765)	(1,657X1,240X765)+ (1,657X1,240X765)+ (1,657X1,240X765)	(1,657X1,240X765)+ (1,657X1,240X765)+ (1,657X1,240X765)	(1,657X1,240X765)+ (1,657X1,240X765)+ (1,657X1,240X765)	(1,657X1,240X765)+ (1,657X1,240X765)+ (1,657X1,240X765)	
Machine weight	kg	285+285+285	285+285+285	285+285+285	285+285+285	285+285+285	
Sound level	dB(A)	65	65	65	66	66	
Operation range	°CDB	15 to 49					
Refrigerant	Type	R-410A					
	Charge	kg	10.3+10.3+10.3	10.3+10.3+10.4	10.3+10.4+10.4	10.4+10.4+10.4	10.4+10.4+10.5
Piping connections (Indoor unit)	Liquid	mm	φ 19.1 (Brazing)	φ 19.1 (Brazing)	φ 19.1 (Brazing)	φ 19.1 (Brazing)	φ 19.1 (Brazing)
	Gas	mm	φ 41.3 (Brazing)	φ 41.3 (Brazing)	φ 41.3 (Brazing)	φ 41.3 (Brazing)	φ 41.3 (Brazing)
Piping connections (Heat exchanger unit)	Inlet pipe	mm	φ 19.1(Brazing)				
	Outlet pipe	mm	φ 19.1(Brazing)				

Note: Specifications are based on the following conditions:

- Cooling: Indoor temp.: 27°CDB, 19°CWB, Outdoor temp.: 35°CDB, Equivalent piping length: 7.5 m, Level difference: 0 m.
 - Sound level: Anechoic chamber conversion value, measured at a point 1 m in front of the unit at a height of 1.5 m.
- During actual operation, these values are normally somewhat higher as a result of ambient conditions.

Standard Type

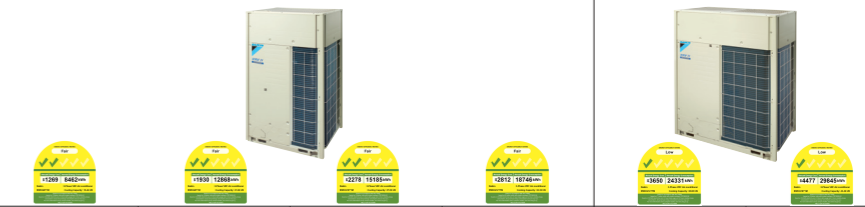

MODEL	RWHQ6TY1	RWHQ8TY1	RWHQ10TY1	RWHQ12TY1	RWHQ14TY1	RWHQ16TY1	
Combination units	—	—	—	—	—	—	
Power supply	3-phase 4-wire system, 380–415 V, 50 Hz						
Cooling capacity	kcal/h	13,800	19,300	24,100	28,800	34,400	38,700
	Btu/h	54,600	76,400	95,500	114,000	136,000	154,000
	kW	16.0	22.4	28.0	33.5	40.0	45.0
Power consumption	kW	3.55	5.13	7.22	8.93	10.8	12.9
Capacity control	%	20-100	20-100	16-100	15-100	11-100	10-100
Casing colour	Ivory white (5Y7.5/1)						
Compressor	Type	Hermetically Sealed Scroll Type					
	Motor output	kW	2.4X1	3.4X1	4.1X1	5.2X1	(2.9X1)+(3.3X1)
Airflow rate	m ³ /min	119	157	165	178	233	233
Dimensions (HxWxD)	mm	1,657X930X765	1,657X930X765	1,657X930X765	1,657X930X765	1,657X1,240X765	1,657X1,240X765
Machine weight	kg	185	185	200	200	285	285
Sound level	dB(A)	55	56	57	59	60	61
Operation range	°CDB	15 to 49					
Refrigerant	Type	R-410A					
	Charge	kg	6.4	6.4	6.5	6.8	10.3
Piping connections (Indoor unit)	Liquid	mm	φ 9.5 (Brazing)			φ 12.7 (Brazing)	
	Gas	mm	φ 19.1 (Brazing)		φ 22.2 (Brazing)	φ 28.6 (Brazing)	
Piping connections (Heat exchanger unit)	Inlet pipe	mm	φ 19.1(Brazing)				
	Outlet pipe	mm	φ 19.1(Brazing)				









Note: Specifications are based on the following conditions:

- Cooling: Indoor temp.: 27°CDB, 19°CWB, Outdoor temp.: 35°CDB, Equivalent piping length: 7.5 m, Level difference: 0 m.
 - Sound level: Anechoic chamber conversion value, measured at a point 1 m in front of the unit at a height of 1.5 m.
- During actual operation, these values are normally somewhat higher as a result of ambient conditions.

Specifications

Outdoor Units

Standard Type

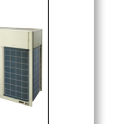
																							
MODEL			RW HQ18TY1	RW HQ20TY1	RW HQ22TY1	RW HQ24TY1	RW HQ26TY1	RW HQ28TY1	RW HQ30TY1			RW HQ32TY1	RW HQ34TY1	RW HQ36TY1	RW HQ38TY1	RW HQ40TY1	RW HQ42TY1	RW HQ44TY1	RW HQ46TY1				
Combination units			RW HQ8TY1	RW HQ8TY1	RW HQ8TY1	RW HQ10TY1	RW HQ12TY1	RW HQ14TY1	RW HQ14TY1			RW HQ14TY1	RW HQ10TY1	RW HQ12TY1	RW HQ8TY1	RW HQ12TY1	RW HQ12TY1	RW HQ12TY1	RW HQ12TY1	RW HQ14TY1	RW HQ16TY1	RW HQ14TY1	
			RW HQ10TY1	RW HQ12TY1	RW HQ14TY1	RW HQ14TY1	RW HQ14TY1	RW HQ14TY1	RW HQ16TY1			RW HQ18TY1	RW HQ12TY1	RW HQ12TY1	RW HQ12TY1	RW HQ18TY1	RW HQ16TY1	RW HQ16TY1	RW HQ16TY1	RW HQ16TY1	RW HQ16TY1	RW HQ18TY1	
Power supply			3-phase 4-wire system, 380–415 V, 50 Hz									3-phase 4-wire system, 380–415 V, 50 Hz											
Cooling capacity			kcal/h	43,300	48,100	53,700	58,500	63,200	68,800	73,100			77,400	81,700	86,900	91,200	96,300	102,000	107,000	112,000			
			Btu/h	172,000	191,000	213,000	232,000	251,000	273,000	290,000			307,000	324,000	345,000	362,000	382,000	406,000	423,000	444,000			
			kW	50.4	55.9	62.4	68.0	73.5	80.0	85.0			90.0	95.0	101	106	112	119	124	130			
Power consumption			kW	12.4	14.1	15.9	18.0	19.7	21.6	23.7			26.1	25.1	26.8	29.4	30.8	32.6	34.7	36.9			
Capacity control			%	8-100	8-100	7-100	6-100	6-100	5-100	5-100			5-100	5-100	5-100	4-100	4-100	4-100	4-100	3-100			
Casing colour			Ivory white (5Y7.5/1)									Ivory white (5Y7.5/1)											
Compressor			Type	Hermetically Sealed Scroll Type									Hermetically Sealed Scroll Type										
			Motor output	(3.4X1)+(4.1X1)	(3.4X1)+(5.2X1)	(3.4X1)+(2.9X1)+(3.3X1)	(4.1X1)+(2.9X1)+(3.3X1)	(5.2X1)+(2.9X1)+(3.3X1)	(2.9X1)+(3.3X1)+(2.9X1)+(3.3X1)	(2.9X1)+(3.3X1)+(3.6X1)+(3.7X1)			(2.9X1)+(3.3X1)+(4.4X1)+(4.0X1)	(4.1X1)+(5.2X1)+(5.2X1)	(5.2X1)+(5.2X1)+(5.2X1)	(3.4X1)+(5.2X1)+(4.4X1)+(4.0X1)	(5.2X1)+(5.2X1)+(3.6X1)+(3.7X1)	(5.2X1)+(2.9X1)+(3.3X1)+(3.6X1)+(3.7X1)	(5.2X1)+(3.6X1)+(3.7X1)	(2.9X1)+(3.3X1)+(2.9X1)+(3.3X1)+(4.4X1)+(4.0X1)			
Airflow rate			m ³ /min	157+165	157+178	157+233	165+233	178+233	233+233	233+233			233+233	165+178+178	178+178+178	157+178+233	178+178+233	178+233+233	178+233+233	233+233+233			
Dimensions (HxWxD)			mm	(1,657x930x765)+(1,657x930x765)	(1,657x930x765)+(1,657x930x765)	(1,657x930x765)+(1,657x1,240x765)	(1,657x930x765)+(1,657x1,240x765)	(1,657x930x765)+(1,657x1,240x765)	(1,657x1,240x765)+(1,657x1,240x765)	(1,657x1,240x765)+(1,657x1,240x765)			(1,657x1,240x765)+(1,657x1,240x765)	(1,657x930x765)+(1,657x930x765)	(1,657x930x765)+(1,657x930x765)	(1,657x930x765)+(1,657x1,240x765)	(1,657x930x765)+(1,657x1,240x765)	(1,657x1,240x765)+(1,657x1,240x765)	(1,657x1,240x765)+(1,657x1,240x765)	(1,657x1,240x765)+(1,657x1,240x765)	(1,657x1,240x765)+(1,657x1,240x765)	(1,657x1,240x765)+(1,657x1,240x765)	
Machine weight			kg	185+200	185+200	185+285	200+285	200+285	285+285	285+285			285+285	200+200+200	200+200+200	185+200+285	200+200+285	200+285+285	200+285+285	285+285+285			
Sound level			dB(A)	60	61	61	62	63	63	64			64	63	64	64	65	65	65	66			
Operation range			°CDB	15 to 49									15 to 49										
Refrigerant			Type	R-410A									R-410A										
			Charge	kg	6.4+6.5	6.4+6.8	6.4+10.3	6.5+10.3	6.8+10.3	10.3+10.3	10.3+10.4			10.3+10.5	6.5+6.8+6.8	6.8+6.8+6.8	6.4+6.8+10.5	6.8+6.8+10.4	6.8+10.3+10.4	6.8+10.4+10.4	10.3+10.3+10.5		
Piping connections (Indoor unit)			Liquid	mm	φ15.9 (Brazing)	φ15.9 (Brazing)	φ15.9 (Brazing)	φ15.9 (Brazing)	φ19.1 (Brazing)	φ19.1 (Brazing)	φ19.1 (Brazing)			φ19.1 (Brazing)	φ19.1 (Brazing)	φ19.1 (Brazing)	φ19.1 (Brazing)	φ19.1 (Brazing)	φ19.1 (Brazing)	φ19.1 (Brazing)	φ19.1 (Brazing)	φ19.1 (Brazing)	
			Gas	mm	φ28.6 (Brazing)	φ28.6 (Brazing)	φ28.6 (Brazing)	φ34.9 (Brazing)	φ34.9 (Brazing)	φ34.9 (Brazing)	φ34.9 (Brazing)			φ34.9 (Brazing)	φ34.9 (Brazing)	φ41.3 (Brazing)	φ41.3 (Brazing)	φ41.3 (Brazing)	φ41.3 (Brazing)	φ41.3 (Brazing)	φ41.3 (Brazing)	φ41.3 (Brazing)	φ41.3 (Brazing)
Piping connections (Heat exchanger unit)			Inlet pipe	mm	φ19.1(Brazing)									φ19.1(Brazing)									
			Outlet pipe	mm	φ19.1(Brazing)									φ19.1(Brazing)									

Note: Specifications are based on the following conditions:

- Cooling: Indoor temp.: 27°CDB, 19°CWB, Outdoor temp.: 35°CDB, Equivalent piping length: 7.5 m, Level difference: 0 m.
 - Sound level: Anechoic chamber conversion value, measured at a point 1 m in front of the unit at a height of 1.5 m.
- During actual operation, these values are normally somewhat higher as a result of ambient conditions.

Specifications

Outdoor Units



Standard Type

								
MODEL		RWHQ48TNY1	RWHQ50TNY1	RWHQ52TNY1	RWHQ54TNY1	RWHQ56TNY1	RWHQ58TNY1	RWHQ60TNY1
Combination units		RWHQ14TY1	RWHQ14TY1	RWHQ16TY1	RWHQ18TY1	RWHQ18TY1	RWHQ18TY1	RWHQ20TY1
		RWHQ16TY1	RWHQ18TY1	RWHQ18TY1	RWHQ18TY1	RWHQ18TY1	RWHQ20TY1	RWHQ20TY1
		RWHQ18TY1	RWHQ18TY1	RWHQ18TY1	RWHQ18TY1	RWHQ20TY1	RWHQ20TY1	RWHQ20TY1
Power supply		3-phase 4-wire system, 380–415 V, 50 Hz						
Cooling capacity	kcal/h	116,000	120,000	125,000	129,000	134,000	139,000	144,000
	Btu/h	461,000	478,000	495,000	512,000	532,000	553,000	573,000
	kW	135	140	145	150	156	162	168
Power consumption	kW	39.0	41.4	43.5	45.9	48.5	51.1	53.7
Capacity control	%	3-100	3-100	3-100	3-100	3-100	3-100	3-100
Casing colour		Ivory white (5Y7.5/1)						
Compressor	Type	Hermetically Sealed Scroll Type						
	Motor output	kW	(2.9X1)+(3.3X1)+ (3.6X1)+(3.7X1)+ (4.4X1)+(4.0X1)	(2.9X1)+(3.3X1)+ (4.4X1)+(4.0X1)+ (4.4X1)+(4.0X1)	(3.6X1)+(3.7X1)+ (4.4X1)+(4.0X1)+ (4.4X1)+(4.0X1)	(4.4X1)+(4.0X1)+ (4.4X1)+(4.0X1)+ (4.4X1)+(4.0X1)	(4.4X1)+(4.0X1)+ (4.4X1)+(4.0X1)+ (4.6X1)+(5.5X1)	(4.4X1)+(4.0X1)+ (4.6X1)+(5.5X1)+ (4.6X1)+(5.5X1)
Airflow rate	m ³ /min	233+233+233	233+233+233	233+233+233	233+233+233	233+233+268	233+268+268	268+268+268
Dimensions (HxWxD)	mm	(1,657X1,240X765)+ (1,657X1,240X765)+ (1,657X1,240X765)	(1,657X1,240X765)+ (1,657X1,240X765)+ (1,657X1,240X765)	(1,657X1,240X765)+ (1,657X1,240X765)+ (1,657X1,240X765)	(1,657X1,240X765)+ (1,657X1,240X765)+ (1,657X1,240X765)	(1,657X1,240X765)+ (1,657X1,240X765)+ (1,657X1,240X765)	(1,657X1,240X765)+ (1,657X1,240X765)+ (1,657X1,240X765)	(1,657X1,240X765)+ (1,657X1,240X765)+ (1,657X1,240X765)
Machine weight	kg	285+285+285	285+285+285	285+285+285	285+285+285	285+285+320	285+320+320	320+320+320
Sound level	dB(A)	66	66	66	67	68	69	70
Operation range	°CDB	15 to 49						
Refrigerant	Type	R-410A						
	Charge	kg	10.3+10.4+10.5	10.3+10.5+10.5	10.4+10.5+10.5	10.5+10.5+10.5	10.5+10.5+11.8	10.5+11.8+11.8
Piping connections (Indoor unit)	Liquid	mm	φ 19.1 (Brazing)	φ 19.1 (Brazing)	φ 19.1 (Brazing)	φ 19.1 (Brazing)	φ 19.1 (Brazing)	φ 19.1 (Brazing)
	Gas	mm	φ 41.3 (Brazing)	φ 41.3 (Brazing)	φ 41.3 (Brazing)	φ 41.3 (Brazing)	φ 41.3 (Brazing)	φ 41.3 (Brazing)
Piping connections (Heat exchanger unit)	Inlet pipe	mm	φ 19.1(Brazing)					
	Outlet pipe	mm	φ 19.1(Brazing)					

Note: Specifications are based on the following conditions:

- Cooling: Indoor temp.: 27°CDB, 19°CWB, Outdoor temp.: 35°CDB, Equivalent piping length: 7.5 m, Level difference: 0 m.
 - Sound level: Anechoic chamber conversion value, measured at a point 1 m in front of the unit at a height of 1.5 m.
- During actual operation, these values are normally somewhat higher as a result of ambient conditions.

Space Saving Type

						
MODEL		RWHQ18TY1	RWHQ20TY1	RWHQ22TSY1	RWHQ24TSY1	
Combination units		—	—	RWHQ10TY1	RWHQ12TY1	
		—	—	RWHQ12TY1	RWHQ12TY1	
		—	—	—	—	
Power supply		3-phase 4-wire system, 380–415 V, 50 Hz				
Cooling capacity	kcal/h	43,000	48,200	52,900	57,600	
	Btu/h	171,000	191,000	210,000	229,000	
	kW	50.0	56.0	61.5	67.0	
Power consumption	kW	15.3	17.9	16.2	17.9	
Capacity control	%	10-100	8-100	8-100	8-100	
Casing colour		Ivory white (5Y7.5/1)				
Compressor	Type	Hermetically Sealed Scroll Type				
	Motor output	kW	(4.4X1)+(4.0X1)	(4.6X1)+(5.5X1)	(4.1X1)+(5.2X1)	(5.2X1)+(5.2X1)
Airflow rate	m ³ /min	233	268	165+178	178+178	
Dimensions (HxWxD)	mm	1,657X1,240X765	1,657X1,240X765	(1,657X930X765)+ (1,657X930X765)	(1,657X930X765)+ (1,657X930X765)	
Machine weight	kg	285	320	200+200	200+200	
Sound level	dB(A)	62	65	61	62	
Operation range	°CDB	15 to 49				
Refrigerant	Type	R-410A				
	Charge	kg	10.5	11.8	6.5+6.8	6.8+6.8
Piping connections (Indoor unit)	Liquid	mm	φ 15.9 (Brazing)	φ 15.9 (Brazing)	φ 15.9 (Brazing)	φ 15.9 (Brazing)
	Gas	mm	φ 28.6 (Brazing)	φ 28.6 (Brazing)	φ 28.6 (Brazing)	φ 34.9 (Brazing)
Piping connections (Heat exchanger unit)	Inlet pipe	mm	φ 19.1(Brazing)			
	Outlet pipe	mm	φ 19.1(Brazing)			



Note: Specifications are based on the following conditions:

- Cooling: Indoor temp.: 27°CDB, 19°CWB, Outdoor temp.: 35°CDB, Equivalent piping length: 7.5 m, Level difference: 0 m.
 - Sound level: Anechoic chamber conversion value, measured at a point 1 m in front of the unit at a height of 1.5 m.
- During actual operation, these values are normally somewhat higher as a result of ambient conditions.

Specifications

Outdoor Units

Space Saving Type

														
MODEL	RWHQ26TSY1	RWHQ28TSY1	RWHQ30TSY1	RWHQ32TSY1	RWHQ34TSY1	RWHQ36TSY1	RWHQ38TSY1	RWHQ40TSY1	RWHQ42TSY1	RWHQ44TSY1	RWHQ46TSY1	RWHQ48TSY1	RWHQ50TSY1	
Combination units	RWHQ8TY1	RWHQ12TY1	RWHQ12TY1	RWHQ12TY1	RWHQ16TY1	RWHQ18TY1	RWHQ18TY1	RWHQ20TY1	RWHQ12TY1	RWHQ12TY1	RWHQ12TY1	RWHQ12TY1	RWHQ12TY1	
	RWHQ18TY1	RWHQ16TY1	RWHQ18TY1	RWHQ20TY1	RWHQ18TY1	RWHQ18TY1	RWHQ20TY1	RWHQ20TY1	RWHQ12TY1	RWHQ12TY1	RWHQ16TY1	RWHQ18TY1	RWHQ18TY1	
Power supply		3-phase 4-wire system, 380–415 V, 50 Hz						3-phase 4-wire system, 380–415 V, 50 Hz						
Cooling capacity	kcal/h	62,300	67,500	71,800	77,000	81,700	86,000	91,200	96,300	101,000	106,000	111,000	115,000	120,000
	Btu/h	247,000	268,000	285,000	305,000	324,000	341,000	362,000	382,000	399,000	420,000	440,000	457,000	478,000
	kW	72.4	78.5	83.5	89.5	95.0	100	106	112	117	123	129	134	140
Power consumption	kW	20.4	21.8	24.2	26.8	28.2	30.6	33.2	35.8	33.2	35.8	37.1	39.5	42.1
Capacity control	%	7-100	6-100	6-100	5-100	5-100	5-100	4-100	4-100	4-100	4-100	4-100	4-100	3-100
Casing colour		Ivory white (5Y7.5/1)						Ivory white (5Y7.5/1)						
Compressor	Type	Hermetically Sealed Scroll Type						Hermetically Sealed Scroll Type						
	Motor output	kW	(3.4X1)+(4.4X1)+(4.0X1)	(5.2X1)+(3.6X1)+(3.7X1)	(5.2X1)+(4.4X1)+(4.0X1)	(5.2X1)+(4.6X1)+(5.5X1)	(3.6X1)+(3.7X1)+(4.4X1)+(4.0X1)	(4.4X1)+(4.0X1)+(4.4X1)+(4.0X1)	(4.4X1)+(4.0X1)+(4.6X1)+(5.5X1)	(4.6X1)+(5.5X1)+(4.6X1)+(5.5X1)	(5.2X1)+(5.2X1)+(4.4X1)+(4.0X1)	(5.2X1)+(5.2X1)+(4.6X1)+(5.5X1)	(5.2X1)+(3.6X1)+(3.7X1)+(4.4X1)+(4.0X1)	(5.2X1)+(4.4X1)+(4.0X1)+(4.4X1)+(4.0X1)
Airflow rate	m ³ /min	157+233	178+233	178+233	178+268	233+233	233+233	233+268	268+268	178+178+233	178+178+268	178+233+233	178+233+233	178+233+268
Dimensions (HxWxD)	mm	(1,657x930x765)+(1,657x1,240x765)	(1,657x930x765)+(1,657x1,240x765)	(1,657x930x765)+(1,657x1,240x765)	(1,657x930x765)+(1,657x1,240x765)	(1,657x1,240x765)+(1,657x1,240x765)	(1,657x1,240x765)+(1,657x1,240x765)	(1,657x1,240x765)+(1,657x1,240x765)	(1,657x1,240x765)+(1,657x1,240x765)	(1,657x1,240x765)+(1,657x1,240x765)	(1,657x930x765)+(1,657x930x765)+(1,657x1,240x765)	(1,657x930x765)+(1,657x1,240x765)+(1,657x1,240x765)	(1,657x930x765)+(1,657x1,240x765)+(1,657x1,240x765)	(1,657x930x765)+(1,657x1,240x765)+(1,657x1,240x765)
Machine weight	kg	185+285	200+285	200+285	200+320	285+285	285+285	285+320	320+320	200+200+285	200+200+320	200+285+285	200+285+285	200+285+320
Sound level	dB(A)	63	63	64	66	65	65	67	68	65	67	66	66	67
Operation range	°CDB	15 to 49						15 to 49						
Refrigerant	Type	R-410A						R-410A						
	Charge	kg	6.4+10.5	6.8+10.4	6.8+10.5	6.8+11.8	10.4+10.5	10.5+10.5	10.5+11.8	11.8+11.8	6.8+6.8+10.5	6.8+6.8+11.8	6.8+10.4+10.5	6.8+10.5+10.5
Piping connections (Indoor unit)	Liquid	mm	φ19.1 (Brazing)	φ19.1 (Brazing)	φ19.1 (Brazing)	φ19.1 (Brazing)	φ19.1 (Brazing)	φ19.1 (Brazing)	φ19.1 (Brazing)	φ19.1 (Brazing)	φ19.1 (Brazing)	φ19.1 (Brazing)	φ19.1 (Brazing)	φ19.1 (Brazing)
	Gas	mm	φ34.9 (Brazing)	φ34.9 (Brazing)	φ34.9 (Brazing)	φ34.9 (Brazing)	φ34.9 (Brazing)	φ41.3 (Brazing)	φ41.3 (Brazing)	φ41.3 (Brazing)	φ41.3 (Brazing)	φ41.3 (Brazing)	φ41.3 (Brazing)	φ41.3 (Brazing)
Piping connections (Heat exchanger unit)	Inlet pipe	mm	φ19.1(Brazing)						φ19.1(Brazing)					
	Outlet pipe	mm	φ19.1(Brazing)						φ19.1(Brazing)					

Note: Specifications are based on the following conditions:

- Cooling: Indoor temp.: 27°CDB, 19°CWB, Outdoor temp.: 35°CDB, Equivalent piping length: 7.5 m, Level difference: 0 m.
 - Sound level: Anechoic chamber conversion value, measured at a point 1 m in front of the unit at a height of 1.5 m.
- During actual operation, these values are normally somewhat higher as a result of ambient conditions.

Specifications

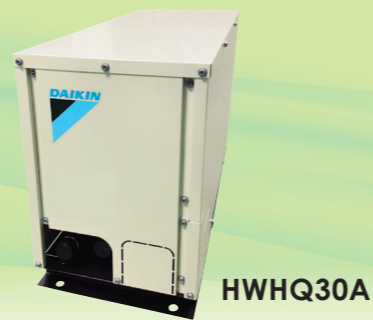

Serpentine Heat Exchanger Unit (HWHQ30A)

HWHQ30A

New Model Name (RWHQ-TY1, HWHQ30A)		RWHQ6TY1 +HWHQ30A	RWHQ8TY1 +HWHQ30A	RWHQ10TY1 +HWHQ30A	RWHQ12TY1 +HWHQ30A
Rated inlet temperature	°C	40			
Rated water flow	L/min	10			
Range of inlet temperature	°C	20 - 65			
Range of water flow	L/min	5 - 20			
Rated Hot-water capacity *1	kW	3.2	3.3	3.3	3.5
Machine weight	kg	27			
Diameter of Refrigerant pipe (Gas)	mm	φ19.1 (Braze)			
Diameter of Refrigerant pipe (Liquid)	mm	φ19.1 (Braze)			
Diameter of water pipe (Inlet)	mm	25A (Screw)			
Diameter of water pipe (Outlet)	mm	25A (Screw)			
Piping length (max)	m	2 (5)			
Design pressure (Water side)	MPa	0.5			
Loss of Head *2	m	0.2			
Casing colour		Ivory white (5Y7.5/1)			
Dimensions (HxWxD)	mm	446 × 306 × 765			

New Model Name (RWHQ-TY1, HWHQ30A)		RWHQ14TY1 +HWHQ30A	RWHQ16TY1 +HWHQ30A	RWHQ18TY1 +HWHQ30A	RWHQ20TY1 +HWHQ30A
Rated inlet temperature	°C	40			
Rated water flow	L/min	10			
Range of inlet temperature	°C	20 - 65			
Range of water flow	L/min	5 - 20			
Rated Hot-water capacity *1	kW	3.7	4.0	4.2	4.4
Machine weight	kg	27			
Diameter of Refrigerant pipe (Gas)	mm	φ19.1 (Braze)			
Diameter of Refrigerant pipe (Liquid)	mm	φ19.1 (Braze)			
Diameter of water pipe (Inlet)	mm	25A (Screw)			
Diameter of water pipe (Outlet)	mm	25A (Screw)			
Piping length (max)	m	2 (5)			
Design pressure (Water side)	MPa	0.5			
Loss of Head *2	m	0.2			
Casing colour		Ivory white (5Y7.5/1)			
Dimensions (HxWxD)	mm	446 × 306 × 765			

Note: It is necessary to satisfy the water standard of Daikin for the water that is used. In the case that the water standard is not satisfied, special measures are required. Please contact your local sales office for details.

*1: [Cooling] Indoor temp.: 27°CDB, 19°CWB, Outdoor temp.: 35°CDB, Inlet water temperature 40°C, Water flow 10L/min, Indoor load 100%, Outdoor-Heat Exchanger Unit 2m.

*2: Water flow 10L/min.

Pipe length restriction of VRV IV Heat Recovery Hot Water System

